

Ultrasonic measurements of the bulk flow field in foams

Nauber, R.; Büttner, L.; Eckert, K.; Fröhlich, J.; Czarske, J.; Heitkam, S.;

Originally published:

January 2018

Physical Review E 97(2018), 013113

DOI: <https://doi.org/10.1103/PhysRevE.97.013113>

Perma-Link to Publication Repository of HZDR:

<https://www.hzdr.de/publications/Publ-25760>

Release of the secondary publication
on the basis of the German Copyright Law § 38 Section 4.

Cite this: DOI: 10.1039/xxxxxxxxxx

Measuring foam flow velocity using Ultrasound Doppler Velocimetry

 Richard Nauber^{*a}, Lars Büttner^a, Kerstin Eckert^c, Jochen Fröhlich^b, Jürgen Czarske^a and Sascha Heitkam^c

Received Date

Accepted Date

DOI: 10.1039/xxxxxxxxxx

www.rsc.org/journalname

In this work, the Ultrasound-Doppler velocimetry has been used to measure the velocity distribution inside a liquid foam bulk. This is the first three-dimensional, non-invasive velocity measurement technique for liquid foam that allows for adequate spatial and temporal resolution. The foam flows upward in a transparent channel. Optical correlation algorithms and conductivity measurement provide reference data. An array of ultrasound transducers is mounted within the channel, sending pulses along the main flow axis and receiving the echos. The penetration depth equals up to 200 mm. With purposely designed flows it is demonstrated that the velocity uncertainty is below 15 percent and the spatial resolution better than 10 mm. These parameters allow for monitoring of industrial processes as well as scientific investigation of three-dimensional foam flow on medium scales.

Introduction

The measurement of the local velocity of flowing foam is a challenging task. Up to now, no technique is available that allows for the non-invasive, spatially and temporally resolved measurement of the foam velocity inside of a foam sample.

Flowing foams play an important role in many industrial processes¹, such as the fractionation of surface active molecules and particles, food production, operation of multiphase-reactors or the production of foam-filled insulation elements. In order to monitor the state of such processes and to regulate certain parameters, a direct, non-invasive measurement of the foam movement is desired.

Also from a scientific point of view the three-dimensional flow of liquid foam is sparsely investigated² because no adequate measurement technique exists. Many experiments rely on optical observation^{3,4}, where the penetration depth is limited by the refraction of light to a few bubble diameters⁵. Other experiments take into account integral values such as volumetric flows or pressure differences⁶. Recently, X-ray tomography has been applied to bubble rearrangement in liquid metal⁷ and to rearrangement of foam around a moving sphere⁸, but this technique requires high energy radiation and is only applicable to tiny measurement

volumes. Also, Le Merrer et al.⁹ used the Laser scatter pattern to instantaneously detect bubble rearrangement in foam, but this technique does not deduce velocity information.

Our approach is the application of Ultrasound Doppler Velocimetry (UDV) to foam. In UDV, a sound pulse is sent through a foam sample and the reflected echo is recorded. From the time of flight one can derive the position of the deflection target and from the Doppler frequency shift its velocity. This technique has already been applied to opaque liquid metal flow^{10–14}, yielding high quality results. However, liquid metal is a continuous fluid with low attenuation of the sound pulse. Reflection targets were well defined by tracer particles occurring naturally as e.g. oxides in the melt.

Measurement of foam with UDV is more challenging, because air absorbs the ultrasound very strongly¹⁵. Also, the deflection targets are soft, spacious and variable air-liquid interfaces instead of particles. Additionally, the speed of sound might change due to scattering at the interfaces.

The goal of the present paper is to demonstrate the applicability of UDV in liquid foam, to evaluate the uncertainty of position and velocity, and to identify limitations.

Materials and methods

Experimental setup

Measurements on the foam velocity are carried out in a fully transparent vertical foam channel made of acrylic glass. The channel is 1150 mm long and has a rectangular cross section (100 mm x 30 mm). At the bottom, compressed air is released

^a Institute of Principles of Electrical and Electronic Engineering, TU Dresden, 01069 Dresden, Germany.

^b Institute of Fluid Mechanics, TU Dresden, 01069 Dresden, Germany.

^c Institute of Fluid Dynamics, Helmholtz-Zentrum Dresden-Rossendorf, Bautzner Landstrasse 400, 01328 Dresden, Germany. Tel: +49 (0)351 260 3870; E-mail: s.heitkam@hzdr.de

through a steel pipe with 100 holes of 0.5 mm diameter, submerged in surfactant solution. This process generates foam with bubbles of (6 ± 1) mm diameter. The foam rises through the channel and is discharged side-wards at the top of the channel. In order to control the liquid fraction, a constant downward liquid flow through the channel can be introduced. To that end, surfactant solution is pumped through porous media in the upper part of the channel.

Different measurement techniques are applied simultaneously. The volumetric flows of compressed air and liquid are detected with two rotameters. The liquid fraction of the foam is detected by conductivity measurement with four pairs of electrodes. Most importantly, optical observation yields the velocity distribution at one surface of the channel. Consecutive images are recorded with 4 px/mm @ 25 fps under back-light illumination. The software package PIVlab¹⁶ is used to derive the foam velocity, applying PIV correlation algorithms.

Since the exact rheological properties of the foam are not in the focus of this study, a cheap and easy to handle surfactant (Gorlen dish-washing soap 'FIT') has been employed. The concentration of 5 g L^{-1} is well above the critical micelle concentration of $(2.0 \pm 0.5) \text{ g L}^{-1}$, yielding a surface tension of $(32 \pm 5) \text{ mN m}^{-1}$.

Two different geometries have been considered (figure 1). The

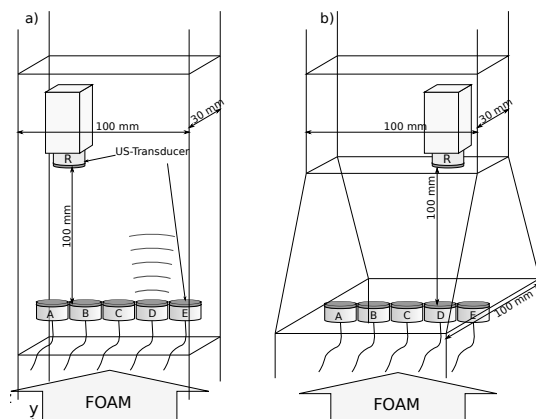

Fig. 1 Arrangement of US-transducer array (A .. E) and reference transducer R in the foam channel (a) the straight channel and (b) nozzle.

straight channel is used to test the different parameters of the UDV postprocessing and to evaluate the damping and deflection properties of foam with different liquid fraction. Varying the volumetric flow of air, the upward foam velocities can be adjusted in order to validate the velocity measurement with UDV. The nozzle configuration is used to impose an inhomogeneous foam velocity field in order to demonstrate the spatial resolution of the UDV.

Ultrasound flow instrumentation

The pulse-echo ultrasound Doppler velocimetry (UDV) allows spatially resolved flow measurements even in opaque liquids.¹⁷ It is based on the emission of short ultrasound bursts into a medium by means of piezoelectric ultrasound transducers. Parameters of the US transducers are given in Table 1. The bursts propagate with the speed of sound c and are reflected by acoustic inhomogeneities, such as tracer particles or liquid/gas-interfaces. The

Table 1 Specification of the ultrasound instrumentation

transducer array	
elements	$n = 5$ cylindrical elements, $d = 19 \text{ mm}$
element pitch	$\Delta x = 20 \text{ mm} = 10.5\lambda$
nominal centre frequency	$f_0 = 175 \text{ kHz}$
acoustical parameters	
speed of sound	$c = 345 \text{ m s}^{-1}$
wavelength	$\lambda = 2.0 \text{ mm}$
measurement parameters	
transmitted signal	square wave $f_0 = 175 \text{ kHz}$ of $n_b = 5$ periods at $u = \pm 80 \text{ V}$
Burst repetition frequency	$f_{BR} = 250 \text{ Hz}$
bursts for velocity estimation	$N_{epb} = 100$
frame rate	$f_{frame} = 2.5 \text{ Hz}$
received signal sampling rate	$f_{samp} = 625 \text{ kHz}$

echoes are received through the same type of ultrasound transducers. The time of flight t_f of the echos is directly related to the covered distance d by $d = t_f c$. This allows for a spatial resolution along the beam propagation axis. The movement of the inhomogeneities with the velocity u along the beam axis causes a continuous shift $\Delta\phi_r$ in the phase of the received echo. This phase shift is determined and averaged for N_{epb} subsequent ultrasound burst echoes with f_{BR} the burst repetition. From the average phase shift $\Delta\bar{\phi}_r$ the velocity of the moving inhomogeneity is determined by¹⁸

$$u = \frac{c}{2} \frac{f_{BR} \Delta\bar{\phi}_r / 2\pi}{f_0} \quad (1)$$

We used a modular ultrasound research platform, the phased array ultrasound Doppler velocimeter (PAUDV)¹⁹. Six identical circular ultrasound transducers with a centre frequency $f_0 = 175 \text{ kHz}$ (MCUSD19A175B11.5RS, Premier Farnell Ltd., Leeds, UK) are mounted in the foam channel. Five ultrasound transducers, labelled 'A' to 'E' form a linear array with a pitch of $\Delta y = 20 \text{ mm} = 10.0\lambda$. The sixth transducer, labelled 'R', is mounted upside-down above the array and serves as reference to deduce the speed of sound and the attenuation of the foam in between.

Each of the transducers can do both, transmitting a burst through the foam, and receiving an echo. Due to slow-decaying reverberations of the transmitting element, the received echo signal of the transmitting element is over-driven for 0.3 ms.

Sequentially, in the order A..E, R one of the transducers transmits a burst through the foam and the other five transducers receive the echo. From each pair of transmitter and receiver, a velocity distribution in the region covered by both (see Figure 4 below) can be determined.

Results

Straight channel

The speed of sound is an important parameter to analyse UDV measurements. It was reported to depend on the bubble size and the liquid fraction¹⁵. For pure air at the ambient temperature of 22°C , it equals $c_0 = 345 \text{ m/s}$. For different liquid fractions c is measured by sending a burst from transducer B to the reference transducer and vice-versa. The time of flight t_f is compared to the empty channel $t_{f,0}$, yielding $c = c_0 t_{f,0} / t_f$. The result is shown in figure 2. For the given bubble size and the relevant liquid fractions below 1%, the speed of sound changes about 10%.

In order to acquire processable data, the attenuation of the burst

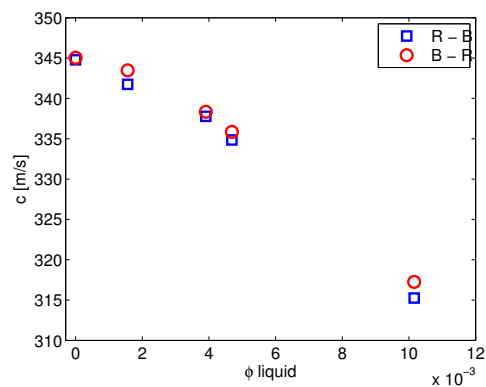

Fig. 2 Speed of sound in foam with different liquid fraction, derived from the time of flight between the reference transducer R and the transducer B and vice-versa. The value $\phi = 0$ represents the empty channel.

must not be too high. The signal intensity is tested by sending a burst from one transducer and averaging the intensity of the signals recorded by the neighbouring transducer over 0.3 ms. Figure 3 shows the intensity of the signal as a function of the liquid fraction of the foam. The signal intensity appears to be the best for foam with roughly $\phi = 0.5\%$ liquid fraction. Suitable UDV measurements were found possible only for liquid fractions below 1%.

To test the accuracy of the velocity measurement, a constant

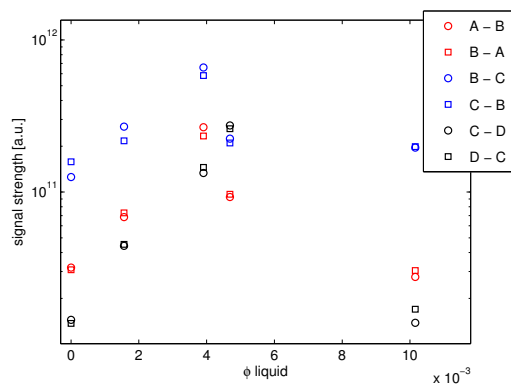

Fig. 3 Signal intensity as a function of the foam liquid fraction. One transducer sends a burst and the signal recorded by neighbouring transducer is integrated over 0.3 ms. The value $\phi = 0$ represents the empty channel.

air flow rate of $11 \text{ cm}^3/\text{s}$ has been applied. The resulting velocity field, measured with the camera, is shown in figure 4.

Simultaneously, UDV measurements are carried out with the transducers A - E. Figure 5 shows the resulting signal intensities and measured velocities, respectively.

In general, the velocities correspond well with the camera measurement. The constant mean velocity is well represented. In the region below 10 mm distance from the transducers, nonphysical velocity fluctuations are measured, presumably resulting from acoustic coupling of sending and receiving transducers. Between

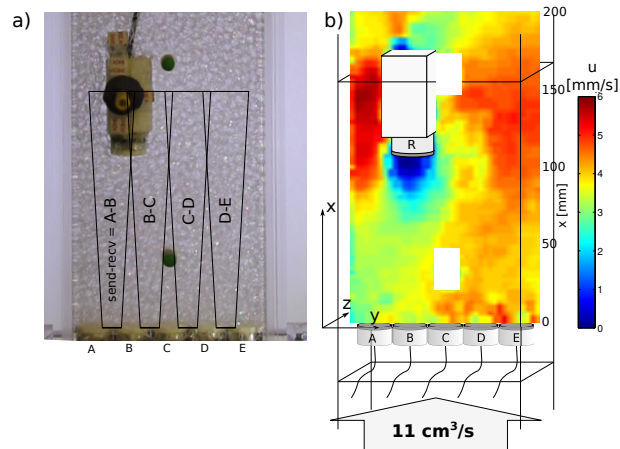

Fig. 4 Foam flow measurement in the straight channel. a) Picture of the applied foam flow, indicating the measurement volumes. b) resulting vertical velocity distribution of the foam for $11 \text{ cm}^3/\text{s}$, measured with optical image correlation. The white spots above transducer C is caused by optical blockage.

10 and 30 mm, the flow accelerates, closing the wake of the transducers. Between 30 mm and 100 mm, a velocity plateau is measured, reflecting the homogeneous velocity distribution in the channel. In this region, deviations from the optical measurement in figure 4 are below 15%. With increasing distance, the signal intensity drops and the measurement becomes unreliable. At a distance of 100 mm, an intensity peak and a velocity minimum is prominent in the lines A-B and B-C. This corresponds to the position of the reference transducer R (visible in Figure 4), reflecting the US burst. The measured velocity is reduced but not zero, because the UDV averages over a certain transversal region, due to the finite beam width.

Nozzle

In order to test the spatial resolution of the sensor, an inhomogeneous velocity field is applied. The foam flows upward through a channel narrowing from $100 \times 100 \text{ mm}^2$ to $100 \times 30 \text{ mm}^2$ cross section. Due to conservation of volume, this causes an acceleration to 3.3 times the inlet speed. The velocity distribution in the channel is given in Figure 6.

Figure 7 shows the resulting signal intensity and the measured velocity, respectively. The theoretical velocity profile, resulting from the conservation of volume, is plotted in figure 7 as well.

It corresponds well with the measured values. The UDV can detect the increase of the velocity and the length of the nozzle. Again, at 100 mm distance, the reference transducer is mounted (see figure 1), blocking the flow and causing an intensity in the data of C-D and D-E. In order to derive an upper limit for the spatial uncertainty in beam direction, let us assume perfect velocity measurement. Thus, the standard deviation of the velocity σ_u would arise completely from the standard deviation of the position σ_x , yielding

$$\sigma_u = \sigma_x \frac{\partial u}{\partial x}. \quad (2)$$

With the given velocity slope of approximately 0.1 s^{-1} and the

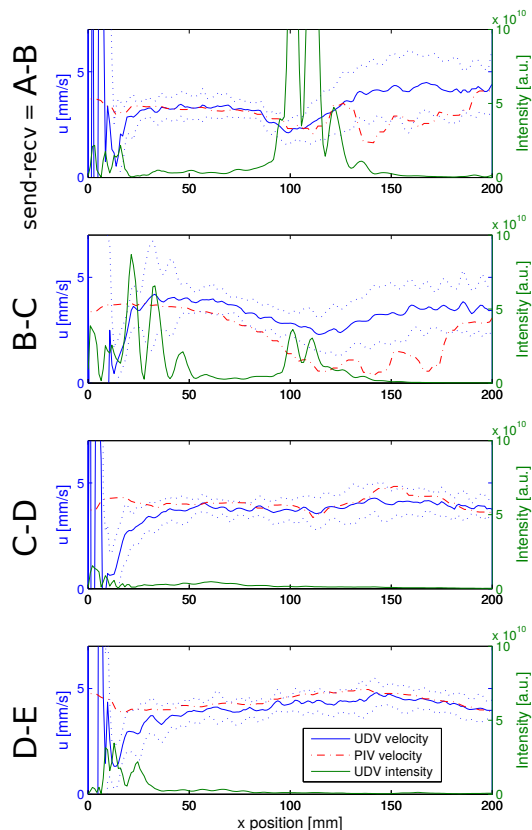

Fig. 5 Vertical velocity distribution in the straight channel, measured by UDV. The dotted line marks the standard deviation of the measurement and the solid green line the corresponding signal strength. The dash-dotted red line gives the expected distribution, derived from the optical measurement in Figure 4.

standard deviation of the velocity of 1 mm s^{-1} this results in a spatial resolution better than 10 mm.

Discussion

Our results demonstrate, that the application of UDV to flowing foam is a promising technique. A velocity uncertainty below 15 % and a spatial resolutions below 10 mm has been achieved. Even though UDV measurement in general works, some limitations exist. Signal strength is crucial in the measurements. Due to the high attenuation of wet foam, the experiments are limited to very dry foam below 1 % liquid fraction. One solution to the intensity problem would be a reduced US frequency. The attenuation of US in air is known to increase with the frequency²⁰. Similar trends are reported in foam¹⁵. However, lower frequencies result in higher wavelengths and the spatial resolution of UDV is known to be in the order of the wavelength (2.0 mm in our case). Thus, lower frequencies increase the signal strength and the penetration depth, but decrease the spatial resolution. Another solution for higher signal intensity would be beam-forming²¹. This al-

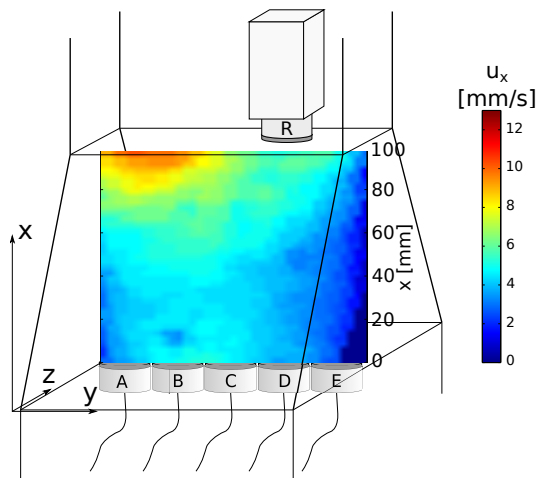

Fig. 6 Vertical velocity distribution in the channel with decreasing cross section, derived from image correlation.

lows the concentration of the US beam in a region of interest, but this requires custom US transducer arrays with an element pitch smaller than a half wavelength.

In conclusion, we successfully measured the velocity of liquid foam, using UDV technique. To the best of our knowledge, this is the first spatially and temporally resolved, noninvasive measurement technique for the velocity distribution in the inside of a foam sample. Thus, UDV could be highly relevant for further investigations on foam flow. Additionally, US transducers are very robust and not as prone to staining as optical methods. Thus, UDV might also be relevant for industrial applications, e.g. the monitoring of froth movement.

Acknowledgements

The support of the DECHEMA (MBFSt-3534) and of the German Research Foundation (HE 7529/1-1 and partially BU 2241/2-1) is gratefully acknowledged.

References

- 1 P. Stevenson, *Foam engineering: fundamentals and applications*, John Wiley & Sons, 2012.
- 2 S. Cohen-Addad, R. Höhler and O. Pitois, *Annual Review of Fluid Mechanics*, 2013, **45**, 241.
- 3 A. Bronfort and H. Caps, *Colloids and Surfaces A: Physicochemical and Engineering Aspects*, 2015, **473**, 141–146.
- 4 B. Dollet and C. Bocher, *The European Physical Journal E*, 2015, **38**, 1–11.
- 5 A. van der Net, L. Blondel, A. Saugey and W. Drenckhan, *Colloids and Surfaces A: Physicochemical and Engineering Aspects*, 2007, **309**, 159–176.
- 6 B. Herzhaft, S. Kakadjian and M. Moan, *Colloids and Surfaces A: Physicochemical and Engineering Aspects*, 2005, **263**, 153–164.
- 7 F. García-Moreno, P. Kamm, T. Neu, K. Heim, A. Rack and J. Banhart, *Colloids and Surfaces A: Physicochemical and Engineering Aspects*, 2017.
- 8 C. Raufaste, B. Dollet, K. Mader, S. Santucci and R. Mokso,

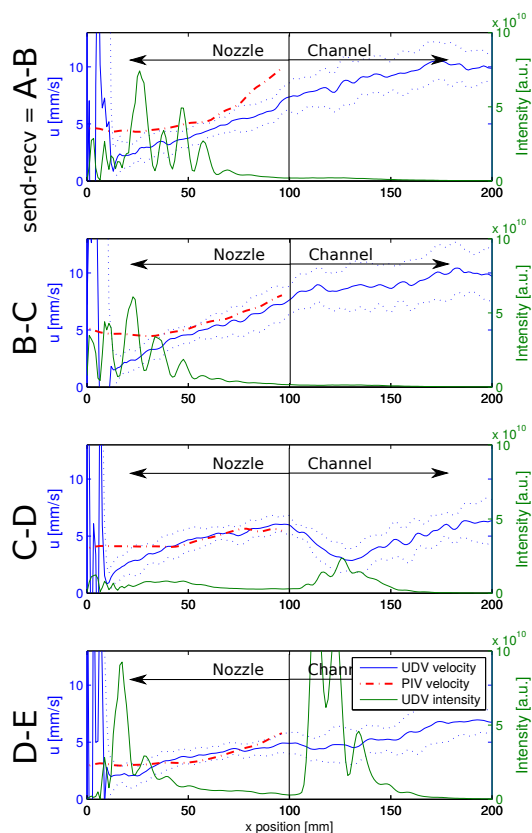

Fig. 7 Vertical velocity distribution in a nozzle, measured by UD V. The dashed line marks the standard deviation of the measurement and the green line the corresponding signal strength. The red line gives the expected distribution, derived from the optical measurement in Figure 6.

EPL (Europhysics Letters), 2015, **111**, 38004.

- 9 M. Le Merrer, S. Cohen-Addad and R. Höhler, *Physical review letters*, 2012, **108**, 188301.
- 10 S. Eckert and G. Gerbeth, *Experiments in Fluids*, 2002, **32**, 542–546.
- 11 S. Franke, L. Büttner, J. Czarske, D. Rübiger and S. Eckert, *Flow Measurement and Instrumentation*, 2010, **21**, 402–409.
- 12 R. Nauber, M. Burger, L. Büttner, S. Franke, D. Rübiger, S. Eckert and J. Czarske, *The European Physical Journal Special Topics*, 2013, **220**, 43–52.
- 13 L. Büttner, R. Nauber, M. Burger, D. Rübiger, S. Franke, S. Eckert and J. Czarske, *Measurement Science and Technology*, 2013, **24**, 055302.
- 14 R. Nauber, N. Thieme, H. Radner, H. Beyer, L. Büttner, K. Dadzis, O. Pätzold and J. Czarske, *Flow Measurement and Instrumentation*, 2016, **48**, 59–63.
- 15 J. Pierre, R.-M. Guillemic, F. Elias, W. Drenckhan and V. Leroy, *The European Physical Journal E*, 2013, **36**, 113.
- 16 W. Thielicke, E. Stamhuis, W. Thielicke and E. Stamhuis, *DOI*, **10**, m9.
- 17 Y. Takeda, *Nuclear Engineering and Design*, 1991, **126**, 277–284.
- 18 W. R. Hedrick, D. L. Hykes and D. E. Starchman, *Ultrasound physics and instrumentation*, Elsevier Mosby, 2005.
- 19 K. Mäder, R. Nauber, V. Galindo, H. Beyer, L. Büttner, S. Eckert and J. Czarske, *IEEE Transactions on Ultrasonics, Ferroelectrics, and Frequency Control*, 2017.
- 20 L. Sivian, *The Journal of the Acoustical Society of America*, 1947, **19**, 914–916.
- 21 O. Von Ramm, S. Smith and F. Thurstone, 1976, 266–270.