

FORSCHUNGSZENTRUM ROSSENDORF FZR - 170

VEREIN für KERNVERFAHRENSTECHNIK
und ANALYTIK ROSSENDORF

VKTA



LOWRAD 96

Methods and Applications of Low-Level Radioactivity Measurements

PROCEEDINGS OF A WORKSHOP
ROSSENDORF/DRESDEN, 7-8 NOVEMBER 1996

Chaired by H. Nitsche (FZR) and S. Niese (VKTA)

Editor: J. Fietz (FZR)

FZR-170
March 1997

FORSCHUNGSZENTRUM ROSSENDORF e.V.
VEREIN FÜR KERNVERFAHRENSTECHNIK
UND ANALYTIK ROSSENDORF e.V.

LOWRAD 96

Methods and Applications of Low-Level Radioactivity Measurements

PROCEEDINGS OF A WORKSHOP
ROSSENDORF / DRESDEN, 7 - 8 NOVEMBER 1996

Chaired by H. Nitsche (FZR) and S. Niese (VKTA)

Editor: J. Fietz (FZR)

**FZR - 170
March 1997**

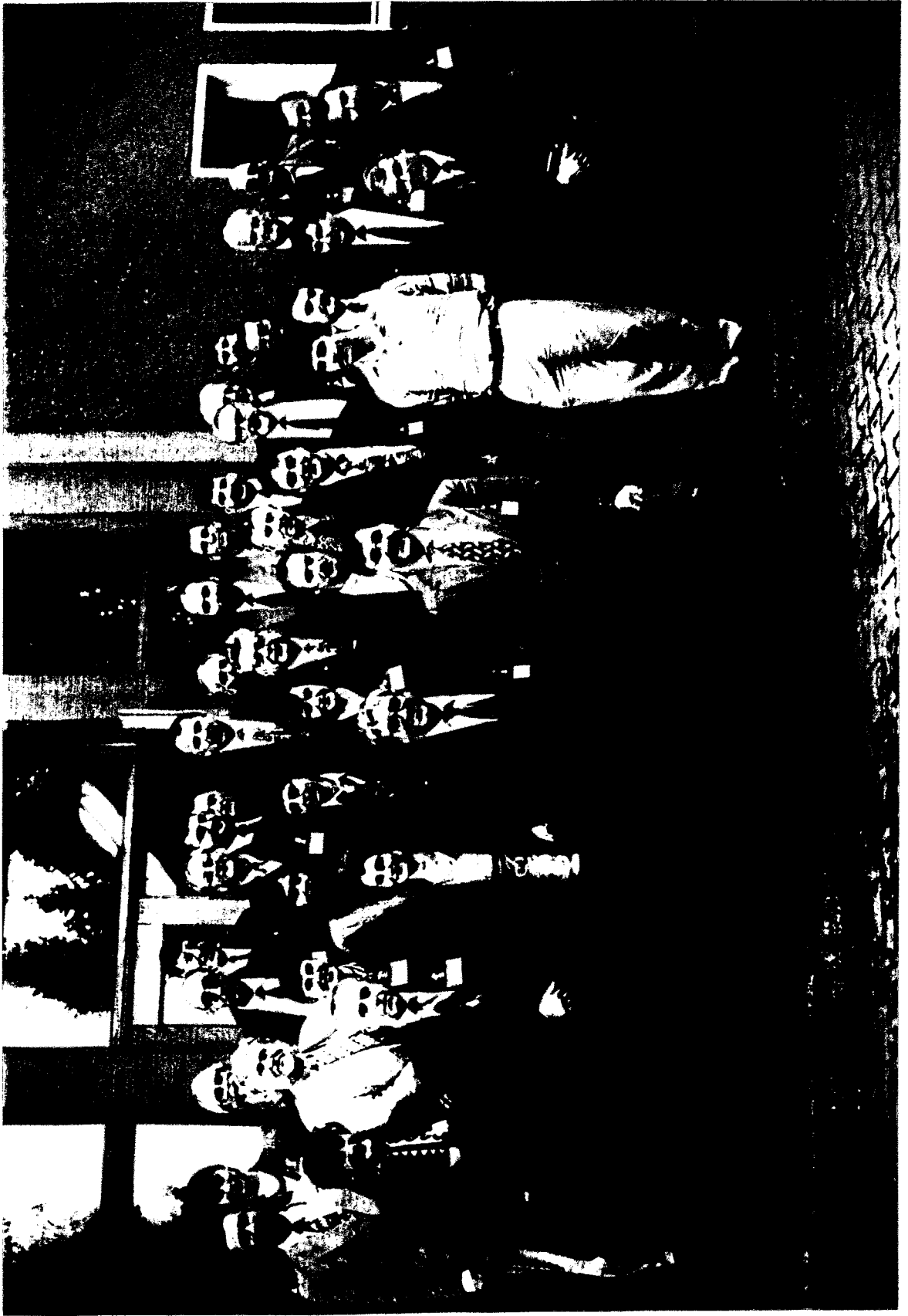

Table of Contents

	Page
Preface	1
I. Analysis of and Influence on Background Spectra Chairperson: D. Mouchel	
Analysis of Background Components in Ge-Spectrometry and their Influence on Detection Limits <i>G. Heusser; Max-Planck-Institute für Kernphysik, Heidelberg, Germany</i>	5
Analysis of Background of Low-Level β/γ - Systems <i>P. Theodorsson; University of Iceland, Reykjavik, Iceland</i>	9
Germanium Crystal Dimensions and their Influences on the Observed Peak-to-Background Distributions <i>W. Wahl, K. König; GSF-Forschungszentrum für Umwelt und Gesundheit, Neuherberg, Germany</i>	13
Low Background Germanium Detectors; from Environmental Laboratory to Underground Counting Facility <i>M. Ceuppens, J. Verplancke, O. Tench; Canberra Semiconductor N. V., Olen, Belgium</i>	19
II. Underground Laboratories Chairperson: G. Heusser	
The IRMM Low-Level Underground Laboratory in HADES <i>D. Mouchel, R. Wordel; Institute for Reference Materials and Measurements, Geel, Belgium</i>	25
Low Background Ge Spectrometry at Gran Sasso Underground Laboratories <i>W. Preusse, C. Bucci, C. Arpesella; Istituto Nazionale di Fisica Nucleare, Gran Sasso, Italy</i>	30
Low-Level Counting Techniques in the Underground Laboratory "Felsenkeller" in Dresden <i>S. Niese, M. Köhler; VKTA Rossendorf e. V., Germany</i>	34
III. Design of Low-Level γ-Spectrometers Chairperson: S. Niese	
Two Low-Level Gamma Spectrometry Systems of the IAEA Safeguards Analytical Laboratory <i>J. L. Parus, W. Raab, D. Donohue, V. Jansta; IAEA, Vienna, Austria</i>	41

Design and Applications of an Anticoincidence Shielded Low-Background Gamma-Ray Spectrometer <i>H. Petry; Forschungszentrum Jülich (KFA), Germany</i>	46
Experiences Gained with an Anti-Compton Spectrometer when Utilized for Measurements of Natural Activities <i>D. Degering; TU Bergakademie Freiberg, Germany</i>	49
Low-Level Multicounter β/γ - Systems with External Guards in Surface and Shallow Underground Laboratories <i>P. Theodorsson; University of Iceland, Reykjavik, Iceland</i>	54
IV. Environmental Behaviour of Radionuclides and Low-Level Measuring Techniques for Exposure Assessment	
Chairperson: W. Görner	
Measurement of Radioactive Nuclides in the "Mayak" Region <i>B. F. Myasoedov, A. P. Novikov; Vernadsky Institute of Geochemistry and Analytical Chemistry, Moscow, Russia</i>	60
Radiochemical Separation of Actinides for their Determination in Environmental Samples and Waste Products <i>B. Gleisberg; VKTA Rossendorf e. V., Germany</i>	65
Internal Dose Assessment due to Large Area Contamination: Main Lessons Drawn from the Chernobyl Accident <i>A. András; KFKI Atomic Energy Research Institute, Budapest, Hungary</i>	71
Measurement of Low Photon Doses using LiF: Mg,Cr,P- und CaF ₂ -Tl - Dosimeters <i>K. Prokert, G. Mann; Technische Universität Dresden, Germany</i>	75
Parameters of a Simple Whole Body Counter and a Thyroid Monitor Established at the Dresden Felsenkeller Underground Laboratory <i>P. Sahre, Th. Schönmath; VKTA Rossendorf e. V., Germany</i>	81
V. Low-Level LSC-Techniques	
Chairperson: P. Theodorsson	
Low-Level Measurements with Liquid Scintillation Spectrometry - Development and Application <i>F. Schönhofer; Federal Institute for Food Control and Research, Vienna, Austria</i>	87
Spectrum Library Concept and Pulse Shape Analysis in Liquid Scintillation Counting <i>L. Kaihola; Wallac Oy, Turku, Finland</i>	91
Low - Level Liquid Scintillation Counting for Quantification of Annual ³ H and ¹⁴ C Concentrations in Tree Disks <i>B. Kopka, J. Schikowski, J. Porstendörfer; Georg-August-Universität Göttingen, Germany</i>	102

Practical Aspects of Tritium Measurement in Ground and Surface Waters <i>O. Nitsche, D. Hebert; TU Bergakademie Freiberg, Germany</i>	106
Radiochemical Trace Analysis Methods: Development and Application of a Fast and Very Sensitive Procedure to Determine Long-Living Neutron Activation Products <i>R. Schupfner, W. König, Ch. Scheuerer, H. Schüttelkopf; Universität Regensburg, Germany</i>	110
VI. Application of Gammasspectrometric Low-Level Measuring Techniques	
Chairperson: A. Andrási	
Neutron Activation Analysis of Low-Level Elemental Contents in Silicon Wafers <i>W. Görner*, A. Berger, S. Niese, M. Köhler, M. Matthes, D. Gawlik; *Bundesanstalt für Materialforschung und -prüfung (BAM), Berlin, Germany</i>	116
Low-Level Gamma Spectrometry of Forest and Moor Soils from Exposed Mountain Regions in Saxony (Erzgebirge) <i>N. Schleich, W. Preusse, D. Degering, S. Unterricker; TU Bergakademie Freiberg, Germany</i>	123
Investigation of Environmental Samples by Low-Level Gamma Spectrometry <i>M. Köhler, S. Niese; VKTA Rossendorf e. V., Germany</i>	127
Approximate Determination of Efficiency for Activity Measurements of Cylindric Samples <i>W. Helbig, M. Bothe; VKTA Rossendorf e. V., Germany</i>	132
Specific Calibration Problems for Gammasspectrometric Measurements of Low-Level Radioactivity in Environmental Samples <i>D. Arnold, H. Wershofen; Physikalisch-Technische Bundesanstalt, Braunschweig, Germany</i>	139
Quality Assurance in the Analysis of Natural Radionuclides - Measures and Results <i>M. Bothe; VKTA Rossendorf e. V., Germany</i>	143
Panel Discussion	147
List of Participants	159

P R E F A C E

The international workshop LOWRAD 96 was held in Rossendorf on November 7 and 8, 1996 with the purpose to a) provide a forum for discussing the newest developments in the field of low-level radioactivity measurements and b) identify potential new applications for existing and new low-level measuring facilities. The meeting was organized by the Institute of Radiochemistry of the Forschungszentrum Rossendorf (FZR), and was hosted together with the Verein für Kernverfahrenstechnik und Analytik Rossendorf (VKTA).

The Rossendorf research site has a long-standing tradition in the field of low-level radioactivity measurements. In 1983 the Dresden Felsenkeller underground laboratory of the former Zentralinstitut für Kernforschung Rossendorf (ZfK) was established and is since then engaged in numerous applications of low-level measuring techniques. After the shutdown of the ZfK, the FZR and the VKTA were founded in 1992 at the same site.

The FZR is engaged in basic and applied basic research in the fields of ion beams and materials research, radiopharmaceutical and radioecological chemistry, safety research and nuclear physics. The VKTA was charged to shut down and decommission most of the nuclear facilities of the former ZfK and is furthermore engaged in environmental radioanalytics. Therefore, and in order to maintain the capability of measuring low-level radioactivity from the site, the Felsenkeller underground laboratory is operated by the VKTA. The laboratory was updated and expanded in 1994.

Our invitation to the LOWRAD 96 workshop was followed by about 60 scientists, representing 10 countries, the International Atomic Energy Association (IAEA) and the Commission of the European Communities (CEC). Twenty seven contributions were presented, invited lectures as well as contributed papers. The presentations were mostly devoted to basic physical aspects and applications of low-level counting. Papers on chemical separation and preparation techniques and on low-level radiation dose determinations were also presented.

The LOWRAD 96 workshop has fulfilled all our expectations: A community of reputed scientists came together to review the state of the art, to present results and to discuss future trends and developments in a scientific field of strongly increasing importance, especially in environmental research. Additionally, the participants had the opportunity to visit the Dresden Felsenkeller underground laboratory and to continue discussions on-site. We sincerely hope that this two-day meeting will benefit the future work of the participants.

This proceedings booklet includes the extended abstracts of all papers that were presented during the workshop, the transcript of the panel discussion and the list of the registered participants.

The organizers would like to thank the Sächsisches Staatsministerium für Wissenschaft und Kunst for financial support which made this meeting possible. Also the contributions of EG & G Berthold, Germany, WALLAC Oy, Finland, and the Austrian Society for Liquid Scintillation Spectrometry helped significantly to make the workshop a success and are gratefully acknowledged.

H. Nitsche

S. Niese

J. Fietz

I. Analysis of and Influence on Background Spectra

Chairperson: D. Mouchel

Analysis of background components in Ge-spectrometry and their influence on detection limits

G. Heusser, Max-Planck-Institut für Kernphysik
P.O. Box 103 980, D-69029 Heidelberg, Germany

In low radioactivity measurements the system own background of the spectrometer is, besides the counting efficiency, the limiting factor for the achievable sensitivity. Since the latter is mostly fixed, background reduction is the only way to gain sensitivity, although it is inversely proportional only to the square root of the background rate but directly proportional to the counting efficiency. A thorough understanding of the background sources and their quantitative contribution helps to choose the most adequate suppression method in order to reach a certain required level of detection limit.

For Ge-spectrometry the background can be reduced by 5 to 6 orders of magnitude compared to the unshielded case applying state-of-the-art techniques. This reduction factor holds for the continuous background spectrum as well as for the line background as demonstrated in Fig. 1 for a Ge-detector of the Heidelberg-Moscow double beta decay experiment [1].

The upper spectrum of Fig. 1 was measured unshielded at the low-level-laboratory of the MPI-Kernphysik [2] and the lower one was measured in a pure lead shield at the Gran Sasso Laboratory [3]. Such a strong reduction in background can only be realized with very careful selection of the detector and shield material for low radioactivity, cosmic ray exposure of the crystal and these materials as short as possible, acid surface cleaning and cleanroom conditions at the assembly phase, and strong shielding against cosmic rays by overburden as well as complete radon suppression during the measurement. With these precautions sensitivities in the range of several $10 \mu\text{Bq/kg}$ can be reached for measuring times of several month.

For normal laboratory work with much shorter sample turnover times less effort may suffice the measuring task. This becomes obvious if we compare typical detection limits (d.l. according to DIN 25482-5 [4]) for the shown spectra of Fig. 1 at e.g. 250 keV with the assumption of continuous background (no line background under the detected peak) and 1 hour measuring time. It results merely in a 34 times lower d.l. for the 10^5 lower background level compared to the unshielded case. Only for much longer counting times the ratio reaches the nominal maximal value of 316 (square root of 10^5) for example: for one day - 136, for 30 days - 266 and for one year - 301.

In surface or near surface laboratories the following background components have to be considered when designing a Ge-spectrometer:

- (a) environmental gamma radiation,
- (b) cosmic ray-induced background,
- (c) radon and its progenies,
- (d) contamination of detector and shield materials,
- (e) neutrons from natural fission and (α , n)-reactions.

They are listed in approximate order of importance, but local variations of e.g. the radon concentration might change the sequence. Progress has been made in recent year in radiopurer detector assemblies by the manufacturers (offered as low background or as ultra low background versions). Also for commercially available shields advances have been made. Therefore, the importance of component (d) is of less importance compared to the past [5].

There exist also interrelations of the different components from interactions within the shield.

At sea level secondary cosmic ray neutrons and muons interact with the shield and thus create tertiary radiation which may reach the detector. The most important reactions are inelastic neutron scattering (γ -emission) and muon induced bremsstrahlung [6, 7]. The latter as well as to a less extend also elastic neutron scattering in the crystal produce a continuous background spectrum with a prominent annihilation peak and the Pb x-rays [5, 6]. Already behind 10 cm of lead this component becomes dominant, so that thicker lead shielding hardly results in further background reduction. The effectiveness for environmental photon suppression is determined by the attenuation of the 2.615 MeV gamma line of ^{208}Tl . Its full nominal absorption for e.g. 10 cm Pb (99.2%) become effective only at lower muon flux in deeper locations or when the muons are suppressed with a cosmic veto shield.

Thus, depending on the overburden of the spectrometer we can reduce the unshielded background in Fig. 1 (top) with 10 cm of lead up to two orders of magnitude almost homogeneously (in log scale) for the shown energy range (up to 2.6 MeV). Here, we have, however, to take into account that the shown spectrum was measured below 15 meter of water equivalent (m w.e.) where the effective neutrons flux (secondary plus muon induced) is reduced already by about the factor 10 and the muon flux by about 2 to 2.5 compared to sea level [5, 6]. At sea level the thermal neutron flux is also higher within the shield. This gives rise to additional lines of thermal neutron capture in Ge [6, 8, 9]. Consequently the higher cosmic ray induced background level behind 10 cm of lead result by about a 10 fold reduction only relative to the upper spectrum in Fig. 1. It gradually increases to two orders of magnitude with the overburden growing higher than 70 to 100 m w.e.. With a cosmic anticoincidence detector system the same reduction can be reached already at a shallower depth of about 15 to 20 m w.e.. The veto detector is preferentially mounted on the outside of the shield as to register muons before they can interact with the shielding material. If they are converted to neutrons they are harder to detect, since the counting efficiency of the veto for neutrons is much lower. For the same reason cosmic veto shields are less effective at sea level with its much higher external neutron flux, [6, 7, 10]. This secondary neutron flux is decreasing rapidly with depth, so that below a few m w.e. of overburden tertiary neutrons produced via muon interaction in the lead become the dominant neutron source. The background effect of these tertiary neutrons (inelastic scattering and excitation of short lived γ lines) is also well suppressed by an cosmic veto shield outside of the lead shield.

Limitation comes here from cosmic induced events, including activation, which have a lifetime exceeding the veto blocking time. At 15 m w.e. this fraction corresponds to about the fourfold total count rate of the lower spectrum in Fig. 1.

Only below 100 m w.e. or below 15-20 m w.e. with an additional veto shield a higher suppression of external photons with further lead becomes sensible. Thus three to almost 4 orders of magnitude of background reduction compared to Fig.1 (top spectrum) are achievable. This is, however, possible only if the detector intrinsic contamination is low enough, radon and its progenies are absent in the shield and the ^{210}Pb contamination of the innermost lead shielding layer is below 2 Bq/kg.

The energetic β rays of the ^{210}Pb progeny ^{210}Bi induce also bremsstrahlung and the characteristic x-rays in lead as muons, but no annihilation. At lower energies up to about 500 keV the ^{210}Bi induced spectrum resembles that of the muonic induced bremsstrahlung spectrum.

For this energy range a ^{210}Pb contamination of about 2 Bq/kg Pb in the innermost 2 cm of the lead shield results in the same count rate as the residual muon induced bremsstrahlung at about 100 m w.e. [6]. At sea level the ^{210}Pb equivalent corresponds to about 140 Bq/kg. Close to 99% of all ^{210}Bi events observed with the detector originate from the first 2 cm Pb facing the detector. The Pb x-rays can be absorbed with an inner Cu lining of about 5 mm, however, at the expense of a slight increase in the range of 100 to 500 keV if muons are present [6].

For the measurement of the lower spectrum in Fig. 1 the detector was shielded by 20 cm Pb of 0.4 Bq ^{210}Pb /kg next to the detector plus 20 cm Pb of 20 Bq ^{210}Pb /kg. Radon influx from the laboratory air is prevented by a tight steel hood around the lead shield that is sealed to a floor plate. N_2 gas is continually flushed with a slight overpressure into the center of the shield. If the 20 l inner space would be open to the laboratory air with 50 Bq $^{222}\text{Rn}/\text{m}^3$ the total count rate (0.1-2.8 MeV) would increase from 50 counts per day to about 3600/cpd and consequently the lower background spectrum of Fig. 1 would be higher by about the same factor. The count rates of the $^{214}\text{Pb}/^{214}\text{Bi}$ γ -lines would be even 1200 times larger.

Exposure to cosmic rays was minimized for the Ge crystal and for other materials of the cryostat. At sea level production rates (mainly from neutron induced spallation reactions) can be as high as 1 mBq/kg e.g. for $^{57}, ^{58}, ^{60}\text{Co}$ from Cu or ^{68}Ge from ^{70}Ge . The full sea level saturation activity would double or even triple the background level of the spectrometer compared to the displayed lower spectrum in Fig. 1. The cryostat is made mainly from Cu of higher radiopurity than 100 $\mu\text{Bq}/\text{kg}$ for each of the primordial radionuclides U, Th, and K. The shielding depth of 3400 m w.e. at the Gran Sasso underground laboratory reduces the muon flux by about 6 orders of magnitude. Thus, muons contribute only approximately 2^{0/00} to the background spectrum.

In Table 1 some orientation is given by which shielding conditions a certain d.l. can be reached. For each factor 10 of background reduction from the upper to the lower spectrum in Fig. 1 the estimated d.l. is given if the counting time is adequately extended. Here it is always assumed that the background components c through e are always well under control.

References

- 1 Balysh A. et al., Phys. Lett. B 322 (1994) 176;
Günther M. et al., to appear in Phys. Rev. D 1996/97
- 2 Heusser G., 1992, Proc. Europhys. Conf. on Nucl. Phys. and Rare Nucl. Processes, 14th, Bratislava, 1990, ed. P. Povinec, p.247, Singapore: World Scientific (1992)
- 3 Belotti E., Nucl. Instr. Meth. Phys. Res. A 264:1 (1988);
Paoluzi L., Nucl. Instr. Meth. Phys. Res. A 279:133 (1989)
- 4 DIN 25482-5 Nachweisgrenze und Erkennungsgrenze bei Kernstrahlungsmessungen, Teil 5 (1993)
- 5 Heusser G., NIM B 17 (1986) 418
- 6 Heusser G., NIM B 83 (1993) 223;
Proc. Int. Summer School, Low-Level Measurements of Radioactivity in the Environment, 3rd, Huelva, 1993, ed. Garcia-Leon M., Garchia-Tenorio R., p.69, Singapore: World Scientific (1994);
Annu. Rev. Nucl. Part. Sci. 45 (1995) 543
- 7 Vojtyla P., NIM B 100 (1995) 87
- 8 Roy J.C., Côte J.E., Durham R.W. and Joshi S.R., J. Radionucl. Nucl. Chem. 130 (1989) 221
- 9 Lindstrom R.M., Lindstrom D.J., Slaback L.A. and Langland J.K., Nucl. Instr. and Meth. A 299 (1990) 425
- 10 Vojtyla P., Beer J. and Stavina, Nucl. Instr. and Meth. B 86 (1994) 380

Table 1: background reduction (relative to Fig. 1)
and the resulting detection limit*

background level [c/keV kg a]	counting time	detection limit*	shielding condition
10^4	10 min	1 Bq	sea level 5 cm Pb or 20 m w.e. no Pb
10^3	2 h	90 mBq	sea level + 10 cm Pb
10^2	1 d	8 mBq	20 m w.e. + 10 cm Pb
10	1 week	1 mBq	20 m w.e. + 15 cm Pb + veto
1	1 month	0.2 mBq	100 m w.e. + 15 cm Pb + veto
10^{-1}	1 a	15 μ Bq	1000 m w.e. + 20 cm Pb

* at 250 keV for contineous background, no line background, $\epsilon = 0.05$

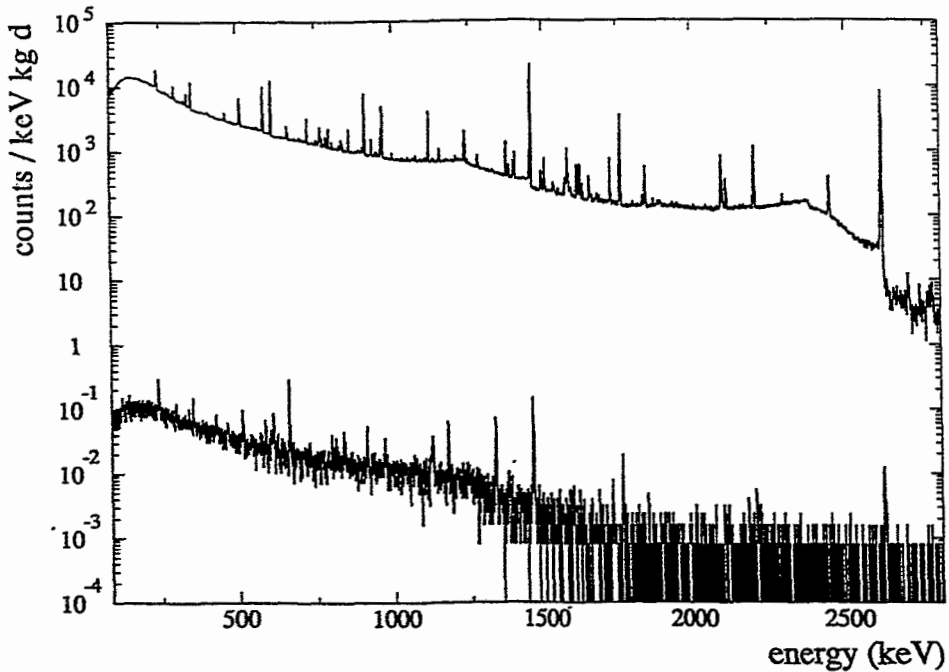

Fig. 1: background spectra of a 2.4 kg Ge detector of the Heidelberg-Moskow double beta collaboration [1] unshielded at 15 m w.e. (top) and shielded with 40 cm lead at 3400 m w.e. (bottom).

ANALYSIS OF BACKGROUND OF LOW-LEVEL β/γ SYSTEMS

Páll Theodórsson

Science Institute, University of Iceland
Dunhaga 3, 107 Reykjavík, Iceland

1. Introduction

A more descriptive version of the title could be: A condensed, coherent, quantitative background analysis. It is condensed because it contains the most important points of an extensive analysis given in a new book [1]. It is coherent as the analysis depends little of the type of detector. This is possible, because all the detectors are exposed to the same radiation and the interaction processes are nearly the same. Finally, the analysis can to a high degree be quantitative, although, with present level of information, it suffers in accuracy. The four main types of low-level beta/gamma detectors — germanium diodes, NaI(Tl) scintillation counters, liquid scintillation counters and gas proportional counters — are discussed.

The introduction of large high-purity germanium diodes in the late 1970s increased the interest in double beta decay as ^{74}Ge was considered a likely candidate for this process. A germanium diode could therefore serve both as a source and detector, provided that its background could be reduced by orders of magnitude. Resources were invested on a scale never before seen in low-level counting for improving these spectrometers. This development work has not only brought us better germanium spectrometers, but also a wealth of very useful information than can now be used in the background analysis also of the detectors. Further, modern low-level germanium spectrometers are the standard against which the background — in cpm/kg — of other beta/gamma detectors should be compared. My background analysis is to a high degree based on the results of these intensive 15 years' studies in various laboratories.

2. Background components

Cosmic rays and primordial radioactivity close to the low-level systems are the source of the background count rate B of β - and γ -detectors. It can be divided into the following components:

$$B = \{B_{\gamma}(Ex) + B_{\gamma}(Ct) + B_{\gamma}(Rn) + B_{\beta}\} + \{B_{\gamma}(Sr) + B_N + B_{\mu}\} \quad (1)$$

where their source is:

$B_{\gamma}(Ex)$: External radioactivity in material outside main shield.

$B_{\gamma}(Ct)$: Gamma-active contamination in shield and materials inside it.

$B_{\gamma}(Rn)$: Radon, which diffuses into cavities in the shield, and its progeny.

B_{β} : Beta-active contamination in the wall of the sample detector.

$B_{\gamma}(Sr)$: Secondary photons (and electrons), excited by muons and protons in the shield.

B_N : Neutrons, induced by muons and protons, mainly in the shielding material.

B_{μ} : Muons, or muon leakage in systems with antic cosmic counters.

In good low-level systems, secondary radiation $B_{\gamma}(Sr)$ is usually a dominant and limiting component. All other components should be reduced well below its level. When this reduction requires a significant effort or cost, a compromise may be necessary. The tolerance level of all minor components should be estimated, i.e., where they contribute about 10% to the total background.

was added between the sample counter and the guard in order to absorb gamma radiation from contamination in the main shield and components inside it. It soon became clear that this arrangement also reduced the background component due to secondary gamma radiation induced by muons and protons in the shield. The highest background reduction could be obtained by having the whole mass of the passive shield inside the guard, that is, an external guard counting system. This was partially tested in a couple of gas proportional counting systems by placing a single, large, flat guard counter on the top of the shield. Although the results were positive, this technique was not developed further.

External guard counters were first introduced in routine use in ultralow-level germanium spectrometers late in the 1980s, for example at the Pacific Northwest laboratory in USA and at Max Planck Institut für Kernphysik in Heidelberg (by G. Heusser). These systems proved the high background reduction efficiency of this arrangement. For economic reasons, a single top guard counter, giving only a partial antic cosmic coverage, has in some cases been used. Now there are probably about 10 such low-level germanium spectrometers. External guard counters have not yet been used with other types of sample detectors.

4. Overburden background reduction

In carefully designed systems the background component due to secondary radiation dominates, also in shallow underground laboratories having an overburden mass m_{ob} of up to 20 meters water equivalent (mwe). Deep underground this component can be reduced practically to zero. A guard counter system externally covering all six sides of the shield will reduce the background of a germanium detector by a factor of about 6 (83% reduction) in a surface laboratory and a factor of about 12 (92% reduction) when the overburden is 15 mwe.

The residual background in well-designed systems is proportional to the flux of the cosmic muons. The value of the flux, compared to its value at zero overburden, is given by

$$A_{\mu}(m_{ob}) = 10^{-1.32 \log d - 0.26 (\log d)^2} \quad (2)$$

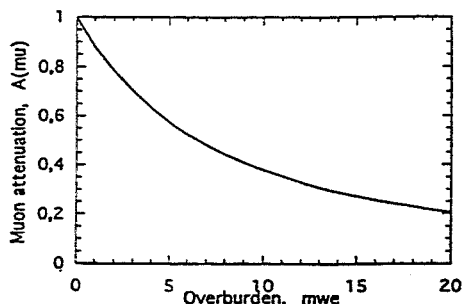

Figure 1. Attenuation factor of muons.

where $d = 1 + m_{ob}/10$ and the overburden m_{ob} is given in mwe. This empirical equation describes the attenuation of the muons to within 5% down to 100 mwe. This attenuation is shown in Figure 1. When it is taken into account that the external guard counter system is about doubly as effective in background reduction at 20 mwe overburden than at zero overburden, we can expect a background reduction of a factor of 10 at this depth, compared to a surface laboratory.

The advantage of lower background in an underground laboratory must be weighed against the disadvantage of taking the samples to a remote counting room. The extra work depends both on the distance and the frequency of sample changing. In most cases the counting time will be a few days, it may even be weeks. With modern technique it is simple to read the the data stored in the system computer through a telephone line. One will therefore only need to come for changing samples.

5. Proposed multicounter systems

Examples of multicounter systems will be given below with a brief description. Ge-detectors are too expensive to warrant a multicounter system. In systems where the detecting medium is either liquid or solid, the pulses from direct hitting muons are large, well above our region of interest. We can therefore tolerate that some of the muons hitting the detector are not detected by the guard detector. We therefore need less geometrical coverage of the sample detector by the guard counter system. This can considerably simplify the guard counter system. A 5-cm-thick layer of lead between the guard counter and the sample detector below will attenuate the secondary radiation formed in the lead above the guard counter by a factor of 10. A single flat guard detector is an acceptable compromise between efficiency and simplicity. In order to maximize background reduction it is probably best to sandwich the guard detector with 5 cm of lead below the guard and 5 cm above it as shown in Figure 2B and 2C. This arrangement can be called a semi-external guard counter system.

Window flow-detectors of for solid β -samples. Multicounters of this type are easy to make and it is a simple matter to construct a unit with 10 to 20 detectors. A typical detector of this type with a window diameter of 25 mm has a background of 0.20 cpm in a surface laboratory. We can expect a background of about 0.01 cpm in a system with an external guard counter system operating under an overburden of 20 mwe.

Internal gas proportional counters, for example for radiocarbon dating, can be improved considerably by replacing the inner guard detector with an external guard counting system. Most of the present systems have a 2-4 cm thick inner shield of lead or mercury, which significantly reduces the background component due to secondary radiation.

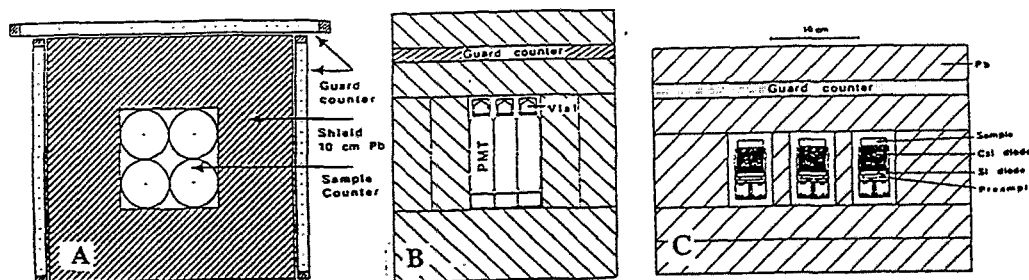

Figure 2. Multidetector systems with antic cosmic shielding: with internal sample gas proportional counters (A), with single PMT liquid scintillation detectors (B) and with CsI gamma detecting crystal where a Si phototube detects the scintillations.

External guard counters will, in addition to reducing the background still further, drastically decrease the mass of the shield, by a factor of about 5, as the guard is removed from the inside of the shield and the conventional 10-15 cm thick layer of boronated paraffin is superfluous. A good counter with a volume of 1.0 liter and working at 3 atm pressure of CO_2 at $M_{\text{ob}}=0$ has a background of about 1.5 cpm. In a system with an external guard (Figure 2A) we can expect a

background of 0.8 cpm in a surface laboratory and 0.20-0.25 cpm at $M_{ob} = 20$ mwe. The total weight of the shield with 9 detectors will be about 1500 kg.

Liquid scintillation counting (LSC) systems. A basically simple multiscouter system with LSC detectors has been described [3]. It uses a single photomultiplier tube (PMT) for light detection and the sample vial is surrounded by a large NaI well guard crystal unit. The background is about 0.35 cpm in a 70% efficiency ^{14}C window. The system proposed here (Figure 2B) has a single semi-external guard counter. In a surface laboratory the background in the ^{14}C window will probably be about 0.5 cpm and about 0.3 cpm in a laboratory with an overburden of 20 mwe. With PMTs made of glass where the radiocontamination has been reduced by a factor of 10 compared to present day glass, I would expect a background count rate of about 0.1 cpm. Because of the simplicity of the sample detector units and the electronics needed, it would be a relatively simple matter to have a system with 9-16 sample channels. Such a system would only weigh about 1000 kg.

NaI and CsI γ -detectors. Ge-spectrometers, with their high energy resolution and low background, largely replaced NaI scintillation detectors in the early 1970s in low-level work. The NaI detectors still have the advantage of lower price, larger detectors and higher intrinsic detection efficiency. The radioactive contamination, which is always present in the glass and ceramic supports of the PMTs, limits seriously the possible background reduction. New phototubes, made of glass where the contamination has been reduced by a factor of 10-20, may partly rehabilitate the NaI units. Multidetector NaI systems with external guard counters in underground laboratories may become an attractive possibility in near future in some low-level gamma work.

Today, very compact CsI gamma scintillation detector units are being produced where large silicone light detection diodes, rather than a conventional PMT, sense the scintillations. These units are completely free of radiocontamination, but electric noise in the diode limits their use to high-energy gamma radiation, above about 300 keV. Figure 2C shows a proposed multiscouter system with a guard counter and 9 such sample detector units.

References

- [1] Pall Theodorsson: Measurement of Weak Radioactivity, (Section 15.7), World Scientific, Singapore, in press..
- [2] H. Schoch, M. Burns, K. O. Münnich and M. Münnich: A multiscouter system for high precision carbon-14 measurements, Radiocarbon 22, 442-447, 1980.
- [3] S. A. Einarsson: Evaluation of a prototype low-level liquid scintillation multisample counter, Radiocarbon 34, 366-373, 1992.

Germanium Crystal Dimensions and their Influences on the Observed Peak-to-Background Distributions

Wolfgang Wahl¹, Karl König²

¹GSF Forschungszentrum für Umwelt und Gesundheit, Institut für Strahlenschutz, AG-Personendosimetrie, D-85764 Oberschleissheim, Germany

²BfS Bundesamt für Strahlenschutz, Institut für Strahlenhygiene, D-85764 Oberschleissheim, Germany

Abstract: This description applies to the parameters of *in vivo* and *in vitro* detection systems as they relate to the type of the detector (or arrangements of detectors) and the performance of the choice. In detail, measurements of a set of pulse-height distributions were done to determine the influence from the detector-crystal dimensions on the peak-to-background variation for point and volume sources as well as ambient radiation. The current capability in suppression of Compton scattered γ -rays using coincidence/anti-coincidence arrangements both for *in vivo* and *in vitro* system are presented. Criteria and relations as well as advantages and disadvantages of the applicability are discussed.

Introduction

There is currently a need for high-resolution, high-sensitive detection systems to study emitted photons in the range of x-rays up to 3 MeV for sample (*in vitro*) or human body (*in vivo*) measurements. It is the purpose, for all different applications, to find the best solution concerning the detection systems taking suitable requirements and current capabilities into account.

Therefore, since the availability of high-purity germanium (HPGe) detectors in the field of radiation monitoring, the most commonly installed high-resolution *in vivo* and *in vitro* systems no longer use scintillation crystals such as NaI(Tl) (Sodium Iodide Thallium activated) or Phoswich arrangements. Due to the excellent capability associated with the energy resolution, even of small size (planar or semi planar) HPGe crystals, but also of highly efficient (coaxial) HPGe crystals (i.e. greater than 3"x3" NaI(Tl) crystals), and their preferred peak-to-total (p/t) and peak-to-Compton (p/C) ratio has become indispensable [1]. Only typical coincidence/anti-coincidence arrangements [2] or array's of detectors which allows the summing of energies deposited in central and neighbour (or segmented) crystals, results in an additional improvement in p/C-ratio.

The most of present approaches in this work are focused to the peak-to-background variation including of that criteria and relations. With the specific aim to be able to identify the lowest limit of detection (LLD), for low energy photon lines less than 1 MeV down to x-rays, emitted from radionuclides into a sample or human body, in the presence of a relatively high (natural) background radiation up to 3 MeV, the dependence on the spectral background influenced by different detector dimensions and mounting materials, different local and ambient source geometries as well as different passive and active shielding concepts will be described.

Measurements

However, studies are presented to the behaviour of different spectral background components, both from the sample and the ambient environment as well as the dependence on the sample geometry, and the dimensions of the semiconductor crystals. The explanations and measurements are responsible for *in vivo* and *in vitro* systems and divided roughly in three parts:

1. The comparison among five or six types of detectors (see Tab. 1) demonstrated with the following three different sources geometries. All the data in this part were measured in a labyrinth shielded room:
 - During the first studies three *point sources* have been used on five separate detector endcaps for 3 different energies (Cs-137, Co-60, Am-241). Fig. 1 shows, as an example, the surprising behaviour of the absolute Compton scattered background, with a very small decreasing at the background amount (not more than 2 to 3) in the energy range of Ba x-rays and backscatter. For comparison, the variation in the crystal volume is more than 400. In Fig. 2, the efficiency/front-surface (for 662 and 1332 keV) and the efficiency (for 59 keV) vs the HPGe crystal front surfaces for three radionuclides are shown.
 - *Volume sources* have been used at the second studies (10 times 2 ltr Kautex bottles) in front of the detector endcap for 3 different energies (Cs-137, K-40, Th-232) and two types of detectors. Those sources are like a phantom to a sufficient part of the body with homogeneously distributed radionuclides, to study the difference opposed to point sources for various crystal dimensions.
 - The third study concerning the *ambient background* was measured in the labyrinth shielded room using 5 types of detectors. Fig. 3 shows the pulse height distributions between 20keV and 750 keV. The 162% p-type crystal has a 700 μ m thick Lithium drifted dead layer on the front-surface to find expression in a decreased efficiency at low energy photons. The calculated cross count rate mainly caused by natural radiation is shown in Fig. 4.
2. The comparison between two shielding concepts responsible for person or sample measurements. Therefore, the data were acquired in a labyrinth room (*in vivo* system) and a low background lead shield (*in vitro* system) using two types of detectors.
3. The comparison between two anti-Compton systems used for *in vivo* and *in vitro* application. The data were measured with two detectors in a lead shield and shadow shielded room:
 - closed 4 π anti-Compton suppression for *in vitro* systems [2].
 - front-open 2 π anti-Compton suppression for *in vivo* systems [3]
 This measurement demonstrates the current capability of anti-Compton arrangements.

Tab. 1: Types of used germanium detectors: the crystal dimensions and the materials (el. = electrolytic, t/f = effective- and front-surface, LB = low background).

type of germanium detectors	crystal			material			property
	e/f-surface cm ²	thickness cm	volume cm ³	mounting	endcap	window	
GEM-162% (p-type)	500/93	8,9	830	Al	AL	Al	standard
GEM-152% (p-type)	/79	11,5	900	Cu (el.)	Cu (el.)	Cu (el.)	LB
GMX-60% (n-type)	244/37.4	7,7	288	Al	Al	Be	standard
LO-AX (n-type)	110/38.5	3,0	115	Al (Cryal)	Mg	C	LB
LO-AX (n-type)	62/20	2,0	40	Al	Al	Be	standard
GLP (p-type)	9/2	1,0	2	Al	Al	Be	standard

Results and Conclusion

Sample (Compton) background (see Fig. 1): Even if the crystal volume is essentially reduced by a factor of 400, the absolute amount of the acquired Compton scattered background in the crystal (induced through photons emitted from nuclides such as Cs-137 or Co-60, ...), for a source on the endcap (less than the diameter or volume of the crystal), cannot be reduced considerable. Therefore, the improvement in the LLD is only 1.5 to 2 in the low energy range (less than 150 keV) where the efficiency is relatively constant in this region using n-type detectors.

Sample peak efficiency (see Fig. 2): Even for high energy photons emitted from a point source on the endcap (such as from Cs-137 or Co-60), it shows that the efficiency is mostly proportional to the entrance surface (not to the volume), independent from the type of coaxial detector. This behaviour is in contrast to the real crystal thickness variation from 1 to 12 cm. Following this surprising result, the smallest, pure planar detector without the coaxial closed-end hole from the back side (opposite to the point source), results in the highest efficiency-to-front-surface ratio (in spite of a worse energy resolution) compared to the largest detector.

Ambient continuum background (see Fig. 3 and 4): The partial variation in the ambient background count rate between 30 keV and 90 keV results in a factor of 10 whereas the cross count rate variation is 280 and the crystal volume variation 400, respectively. Therefore, the cross count rate to the effective-surface ratio is nearly constant.

Ambient peak background (see Fig. 3): The ambient low energy photons are sufficiently suppressed by using a standard shielding design. The next step in reducing the same background components but from local sources requires the use of low background mounting materials for the detector and the exchange of the air radioactivity in the vicinity of the detector. The inclusion from a standard low background lead shield reduces the continuum background additionally by a factor of two to three, where the peak background is entirely reduced excepted the 511 keV.

4 π anti-Compton arrangements (see Fig. 5): Fig. 5 shows the state of art Compton suppression [2] with about 60 for Co-60 (23 for Cs-137) at the Compton edge and 30 in the average, from the Compton edge down to 10 keV. For a multi photon transition nuclide with 3 to 4 de-excites by γ -cascade, the suppression is nearly 100.

2 π anti-Compton arrangements: Necessary for *in vivo* systems is arrangements with a divergent front open collimator. Therefore, the improvements are best in the range of backscatter to Compton edge by 4 to 6 [3] and mostly efficient for nuclides in the body such as K-40 that means the source is placed in front of the detector.

Comparison in background reduction (see Fig. 6): This figure shows the comparison of two *in vitro* systems: a standard lead shield using a detector with aluminium mounting as well as a standard low-level lead shield with a low-level detector mounting. Four typical photon energies are used to demonstrate the current capability of laboratory spectroscopy system (left side nuclide descriptions are from low-level and right side from standard system).

References

- [1] R.M.Keyser et al, The Benefits of Using Super-Large Germanium Gamma-Ray Detectors for the Quantitative Determination of Environmental Radionuclides, Radioactivity & Radiochemistry, Journal of Applied Measurement (Spring 1990) 47 -56
- [2] W.Wahl et al, Enhancement of Compton Suppression Ratios in Anti-Compton Techniques: The Garching & Karlsruhe Photon Spectrometers Nucl.Instr.and Meth. A 369, (1996) 627-633
- [3] W.Wahl et al, In-Vivo Monitor for Body Activity Measurements Applicable for Workers, Patients and Children Using a Passive and Active Shielding-Detection Concept, submitted to Health Physics, 1996

Fig. 1: ^{137}Cs point source on the detector endcap

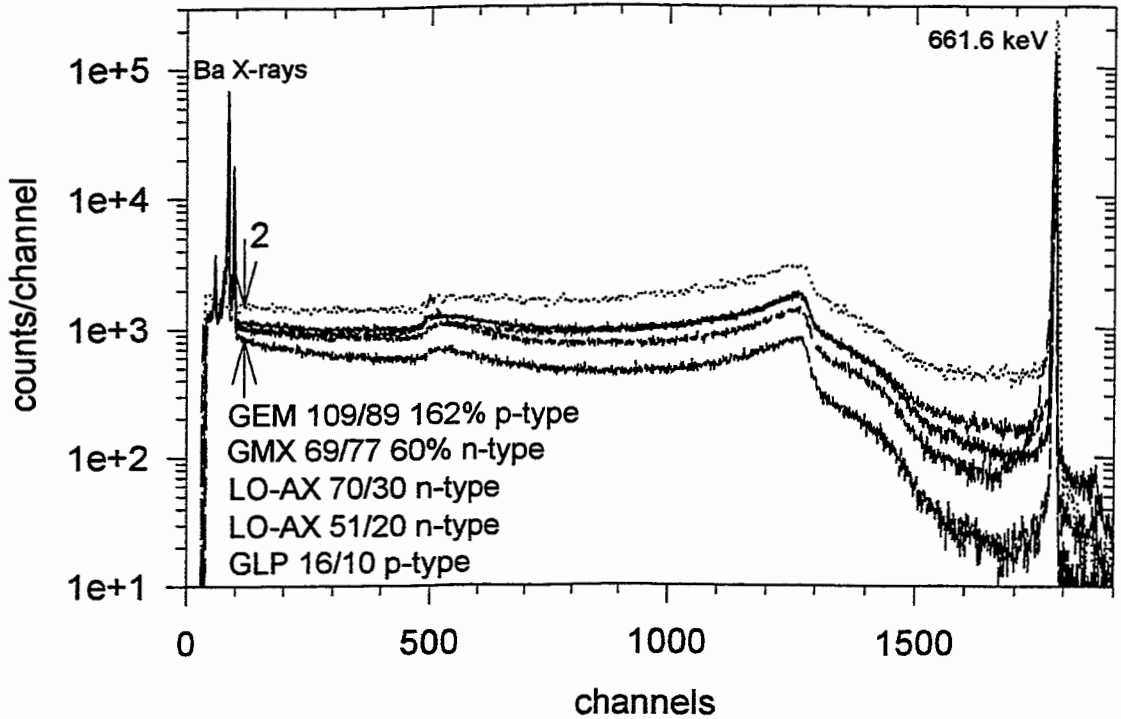

Fig. 2: Am, Cs, or Co point source on the endcap

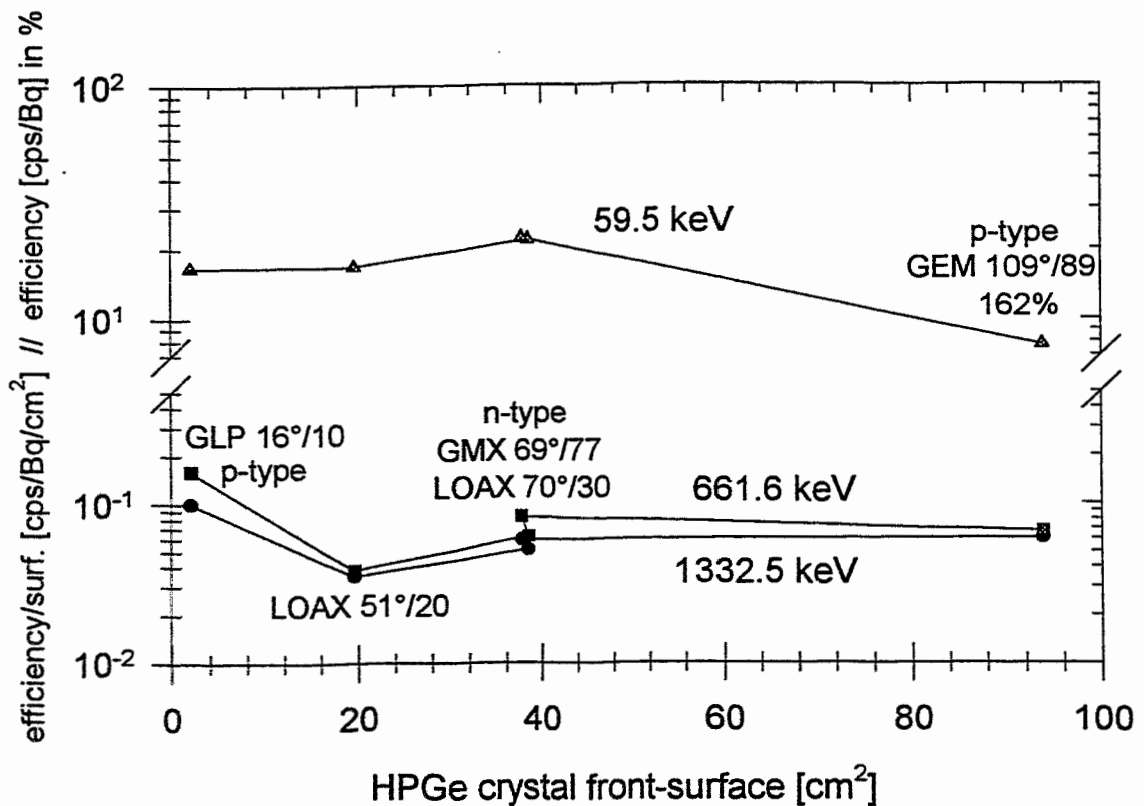

Fig. 3: Ambient background measured in the labyrinth

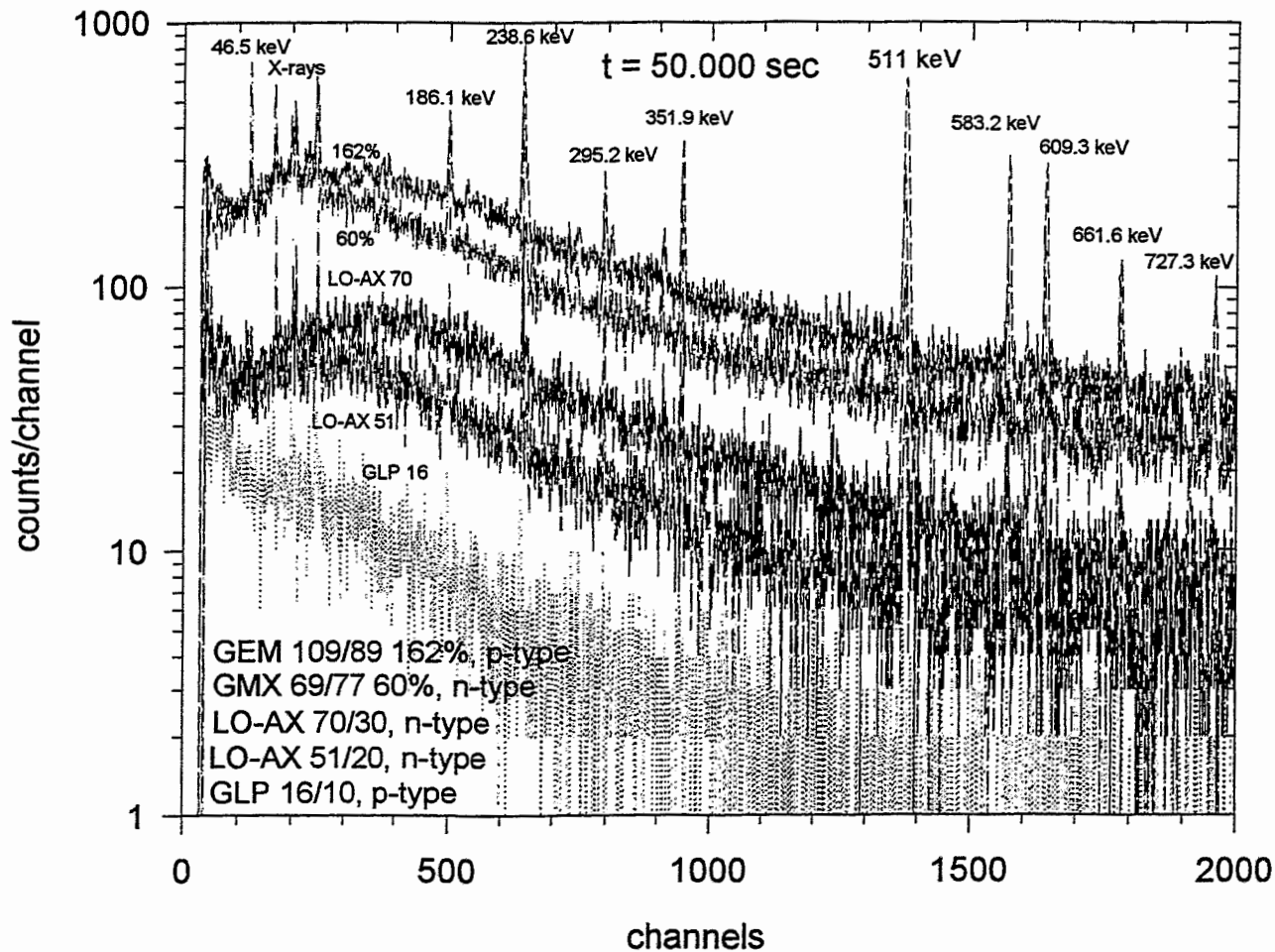

Fig. 4: Bkg. cross count rate (ccr) interval: [12 keV - 3 MeV]

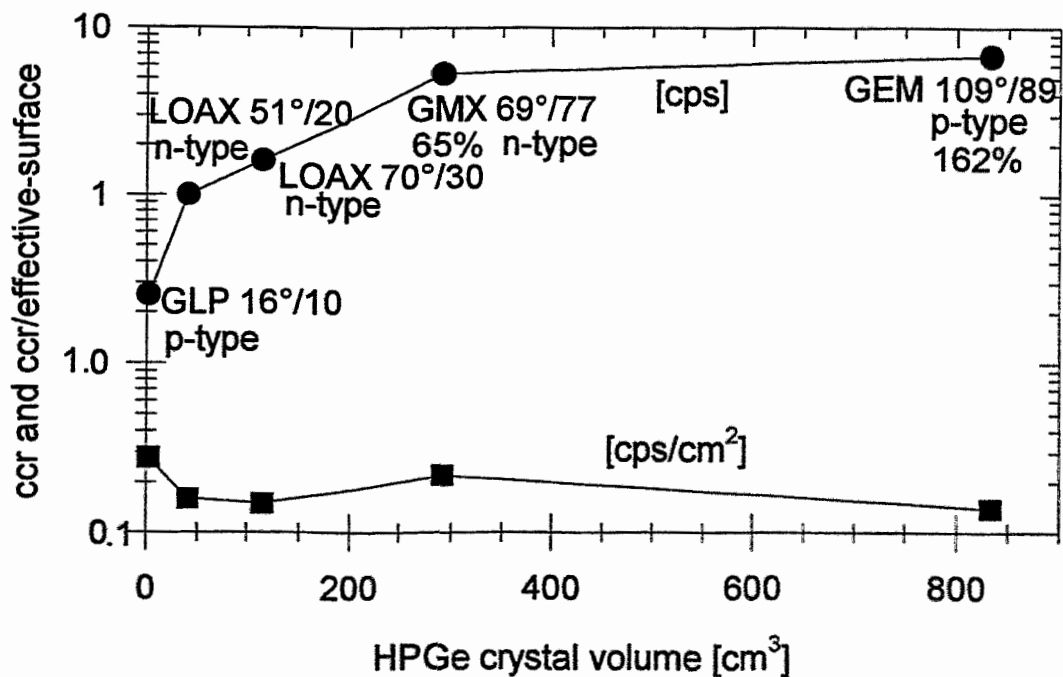

Fig. 5 LO-AX Detector: Co-60 point source on the endcap with and without anti-coincidence

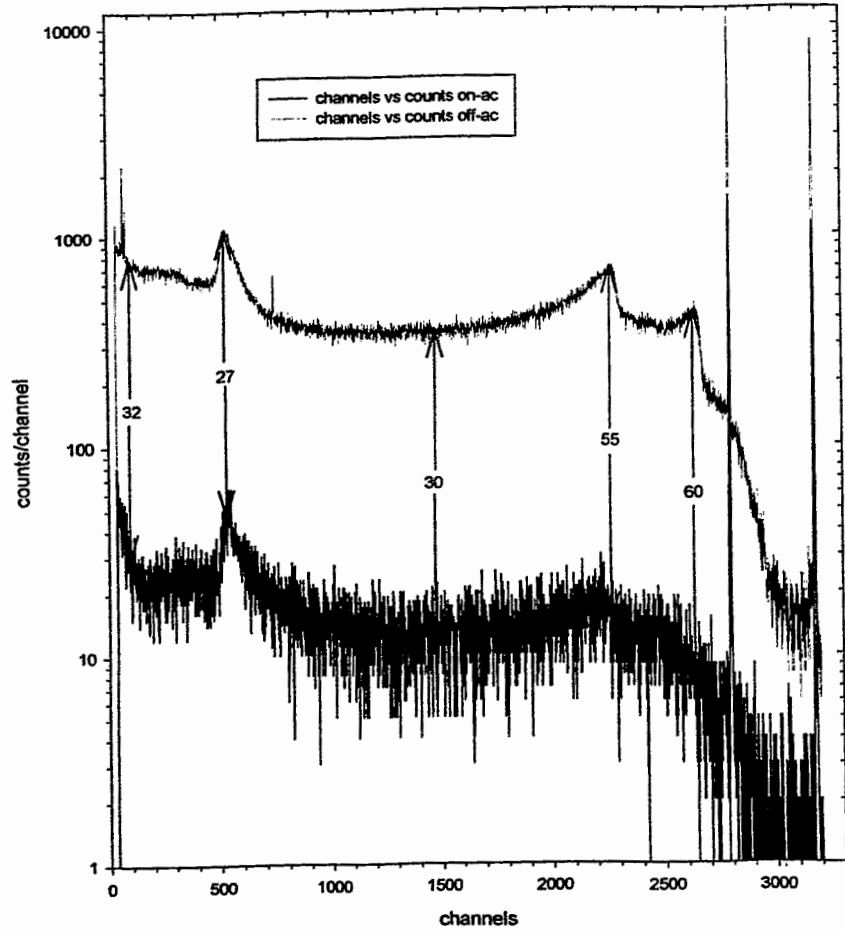
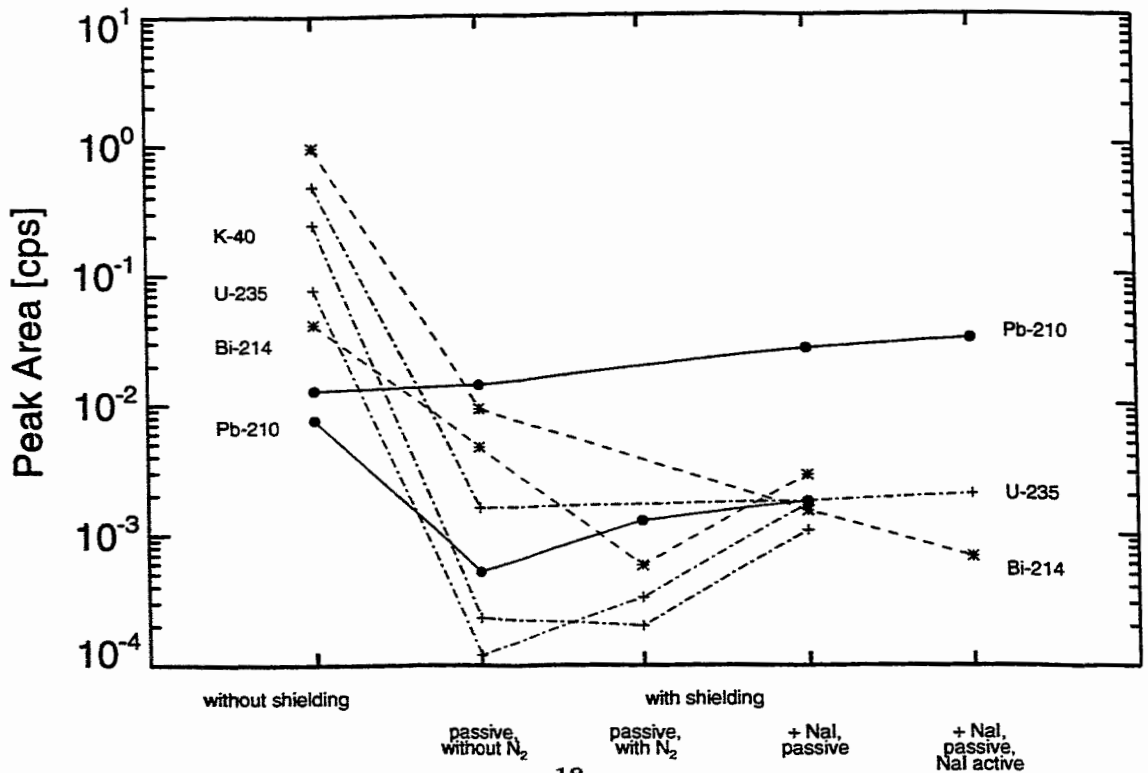

Fig. 6: Behaviour of Peak-Areas of Interest as a Function of Shielding Technology



**LOW BACKGROUND GERMANIUM DETECTORS ;
FROM ENVIRONMENTAL LABORATORY
TO
UNDERGROUND COUNTING FACILITY**

Ceuppens Michel, Jan Verplancke, Orren Tench

Canberra Semiconductor N.V., Olen Belgium
Canberra Industries Inc., Meriden USA

1) Introduction

Low-background germanium detectors are widely used in measuring low levels of radioactivity in research areas as diverse as: geological and biological sciences, environmental restoration of former nuclear sites, health physics, dating, non-proliferation and the latest generation of neutrino physics instrumentation. Each of these applications has its own unique requirements for detectors, sample sizes, activity levels and location of the detection system, as well as the complementary products necessary in a low-background gamma analysis system.

We will try to give in this presentation an overview of different Low Level measuring systems ranging from the environmental lab to low-background detection systems and to the deep underground counting facility. Examples and performances for each of these will be given. Attention will be given to the standardised ultra low-background detectors and shields which provide excellent performance without the high cost in time and money associated with custom designed systems.

2) Background components, origin and classification

Table 1 gives a short overview of the different background sources, some examples and a few hints on how to improve the background for any particular source. Unfortunately as is often the case in the real world some require opposite solutions for different sources and so compromises will have to be accepted. In order to shield more of the environment one would like to use as thick a leadshield as the laboratory floor can carry (or money can buy) but more lead was shown to increase by as much as ten times the neutron flux inside the leadshield[1], thus raising the cosmogenetic contribution.

Although not generally associated with Gamma spectroscopy, some form of sample preparation can be beneficial to the background behaviour of the detection system. Doing chemical separations to concentrate the isotopes of interest is often too tedious a task and the errors associated with it make it very unpopular, but a simple water evaporation in case of large water samples can be quite beneficial both in reducing the thermalisation of neutrons and increasing the geometrical efficiency. It would enable one to use a well type detector, which has been shown to have about 10 times higher efficiency for small samples than a comparable coaxial detector.[2]

3) Optimising Detector cryostat lay-out

It is a good practice to keep all parts that are not really necessary, outside the shielding. Some parts however can not be removed far from the detector element and these are the most important in the background behaviour. Good LB alternatives exist for crystal holder, endcap, window and support but are not readily available for electronic

components.[4] It would be an impossible job to start selecting both for good electronic characteristic and low background behaviour all the components in a preamplifier. Luckily locating this preamplifier outside the shielding has no major effects on the resolution and stability of the detector. This then leaves only the FET assembly electronics (FET, feedback resistor, feedback capacitance) to be selected and/or internally shielded.

Table 1 :

Origin/Source	Background component	Example	Solution
Environment	- Natural radioactive series - Man made RA isotopes - Radon emanation - Building materials	- ^{238}U , ^{40}K , ^{222}Rn - Chernobyl fall-out, contamination by samples, test sources - Ill ventilated cellars - Gypsum	- Use shielding around detector - Decontaminate laboratory - care in sample handling - Ventilate counting room - Check building materials
Sample	- Compton scattering - Bremsstrahlung - Other radio-isotopes present - Thermalisation of cosmogenetic neutrons	- Primary photons are scattered in the sample - β -decay - ^{40}K - 5 l marinelli beakers water-filled	- Limit amount of sample, use high Z sample matrix - Use low Z-matrixes - Chemical purification - Evaporation of sample water
Cosmic radiation	- Cosmogenetic isotopes - Nuclear reactions in detector/shield - Bremsstrahlung - Charged particles in detector	- ^{54}Mn , $^{75\text{m}}\text{Ge}$, ^{60}Co ... - $^{72}\text{Ge}(\text{n,n}')^{72}\text{Ge}$, positron annihilation - Background continuum - Muons	- Avoid activation of parts - Use cosmic Veto shield - Use deep under ground lab
Detector/shield	- Man made RA isotopes - Natural RA isotopes - Cosmogenetic isotopes - Nuclear reactions in Detector - Nuclear reactions in shield	- ^{137}Cs , ^{60}Co , ... - ^{214}Bi , ^{210}Pb , ^{40}K ... - ^{54}Mn , $^{75\text{m}}\text{Ge}$, ^{60}Co ... - $^{74}\text{Ge}(\text{n,n}')^{74}\text{Ge}$ - $^{208}\text{Pb}(\text{n,n}')^{208}\text{Pb}$	- Select materials - Use pure , selected materials - Use deep under ground lab - Use cosmic Veto shield - Limit Mass of shielding

The traditional way of locating the preamplifier outside the leadshield and out of the line of view of the detector element is using a U-style cryostat. There is also the Remote Detector Chamber (RDC), that can achieve the same benefits as U-style cryostats, with a set-up close to the traditional, space-saving, vertical build up of dewar, detector, shield.[3] Only necessary materials are in the leadshield, and the offset between the RDC neck and dipstick effectively blocks the view of preamplifier parts and molecular sieves. We are then left with a limited amount of materials that require selection. Below is a short summary of the important points concerning those parts :

- Free of natural and man made radioactive isotopes
- Small cross section for (thermal and fast) neutrons
- Mechanically stable, both at room temperature and LN2 temperature
- Low outgassing, good insulator (5000 V), good thermal conductor,
- Availability in reasonable quantities and price

Although it is fairly easy to find materials free of man made activities, this is not completely the case for the natural U and Th chains. Once this selection is done the surfaces of these parts have to be cleaned in appropriate ways [4], in order to remove any surface (radon) contamination. In order to avoid consecutive contamination, the mounting of the detector can be done under filtered, laminar flow air streams, and using clean room techniques.

3.a) Comparing cryostat types

The same crystal (30% N-type) was mounted consecutively in a) a standard vertical dipstick, slimline cryostat (-7500SL) b) a standard vertical dipstick, slimline cryostat, using low background materials in the crystal vicinity (-7500SL-LB) c) a standard vertical dipstick, slimline cryostat, using low background materials in the crystal vicinity and a low activity lead disk between crystal and preamplifier(-7500SL-LB/PB) d) a Remote Detector Chamber cryostat, using low background materials for the parts inside the leadshield (-7500SL-RDC-ULB). This was each time measured for a minimum of

200.000 s in a Low Level leadshield [85 mm lead (50 Bq/kg ²¹⁰Pb), 15 mm old lead (<10 Bq/kg ²¹⁰Pb), 4 mm high purity Cu].

3.b) Results

First we want to make a difference between peak background and continuum background. The crystal mounted in a standard cryostat gave rise to more that 50 peaks in the background spectrum whereas in the ULB version not more than 13 could be positively identified. In the first case these were mainly from decay of U/Th daughter isotopes whereas the last, with the exception of ⁴⁰K, were of cosmogenetic origin.

Cryostat Model	CPH/keV						Total CPS
	Energy Range in keV						
	50-100	100-300	300-600	600-1000	1000-1500	1500-2000	
7500SL	26.7	15.7	6.6	3.2	1.5	0.6	2.36
7500SL-LB	15.5	11.9	4.7	2.1	1	0.5	1.71
7500SL-LB(PB)	28.3	11.9	4.2	1.9	1	0.5	1.53
7500SL-RDC-ULB	8.9	7.9	3.5	1.6	0.8	0.5	1.22

Table 2 : Background continua in different cryostat types

Easier to quantify, and of more important in terms of MDA, are the background continuum. The results of these are summarised in table 2. It is clear that, especially in the lower energy region, major differences can be found. Seen MDA changes

$\propto \sqrt{\text{Background}}$ it is clear that for example ²³⁹Pu (129 keV) this gives a factor 1,4 lower MDA, solely based on the background continuum.

4) Optimising shielding

A similar series of tests was carried out, but this time using a 100 % Rel. Eff. Coaxial P-type detector. (A) a P-type coaxial, 100 % Rel. Eff. And 2,2 keV FWHM @ 1,3 MeV, in standard slimline cryostat standing on the laboratory floor. (B) id. in a normal 10 cm leadshield. (C) Id. But with detector mounted in U-style ULB cryostat in 10 cm leadshield. (D) id. in 10 cm Low Background leadshield (85 mm Boliden lead < 50 Bq/kg, 15 mm Old lead < 10 Bq/kg) and (E) id. in 15 cm Ultra Low Background leadshield.

Energy region keV	Background Continuum in CPH/keV				
	A	B	C	D	E
45-100	820.5	22.7	14.2	12.1	9.8
100-300	1238.3	17.8	15.2	13.1	8.5
300-600	348	8.4	7.6	6.7	5.6
600-1000	139.4	4.2	3.2	3.2	3.1
1000-1500	88.3	2.1	1.6	1.6	1.4
1500-2000	16.9	1.1	0.9	0.9	0.8
2000-3000	7.8	0.4	0.6	0.6	0.4
Total in CPS	140.4	2.9	2.6	2.4	1.7

Table 3 :
Background continua in different shielding for 100 % Coaxial Ge detector
A: No shielding
B: 10 cm Pb, Std. Cryostat
C: 10 cm Pb, U-style-ULB
D: 10 cm LB Pb, U-style-ULB
E: 15 cm ULB Pb, U-style

We also want to point out here that although some very nice lead (< 1 Bq/kg ²¹⁰Pb) is available in small quantities, and on occasional bases, no regular supply of this can be secured. However the continuum in these shield is dominated by the cosmic radiation so there is little to be gained by using rare and expensive lead. (Compare C & D)

In (E) care was taken to avoid any streaming from active parts. The materials with large neutron cross section (Cd & Cu) were completely or partially replaced by ULB grade tin. A total of 150 mm lead, with the inner 25 mm < 25 Bq/kg, was chosen.

4.1) Results (See table 3)

The three last columns of table 3 compare an identical, 100 % Rel. Eff. Ge detector in a U-style ULB cryostat, so only influence of shielding has to be taken into account. It is clear that, a thicker leadshield can improve on the background behaviour. This was confirmed by Monte Carlo simulations [5]. We want to point out that in this case there was no major overhead structure, so the main shielding mass is the lead

5) MDA

All these results should be interpreted in terms of their influence on the MDA.

As $MDA \propto \sqrt{Background} (Eff)^{-1}$ it pays more to optimise the detection efficiency.

Optimising efficiency can be achieved, not only by choosing a more appropriate detector, but also by optimising the sample-detector geometry, e.g. use marinelli beaker, if much sample is available, or well geometry in the opposite case.

For an isotope like ^{241}Am (60 keV), there would be a decrease in MDA of 50 % between a standard gamma spectroscopy system (B) and a ULB version (E). For higher energy emitting isotopes the difference becomes rapidly smaller and priority should probably be given to efficiency. E.g. ^{137}Cs (661 keV) will have only 15 % MDA difference.

6) Custom Designed Low Background

Apart from these standard ULB gamma spectroscopy systems there also is a need for detectors with extremely low background behaviour. These are generally used in deep underground counting facilities or using some form of active (anti cosmic veto) shielding. This can range from detectors intended to measure very weak sources [6] to astrophysics and neutrino related studies. The requirements of these systems are such that no standard solutions can be offered and each detector will be custom designed. Some spectra will be discussed during the talk.

7) Conclusion

Optimising cryostat and leadshield geometry's, selecting materials and using appropriate mounting techniques, results in gamma spectroscopy systems with much improved background behaviour. This can be achieved, for surface laboratories, at reasonable cost and with standard available models. This product range has been arbitrarily called Ultra Low Background. The advantages are mainly the known background behaviour of such systems and the short delivery times. With regard to MDA these systems are close to the limit of what can be achieved in normal, ground level laboratories, where the cosmic induced background dominates. The influence of background alone on MDA is strongly dependent on the energy.

Applications where the cosmogenic background has been strongly reduced, require more elaborate detectors, called Custom Design Low Background.

References

- [1] J.A. Da Silva et al., Nucl. Instr. and Meth. A354 (1995) 553
- [2] J-L Reyss et al, Nucl. Instr. and Meth. A357 (1995) 393
- [3] J. Verplancke, Nucl. Instr. and Meth. A312 (1992)176
- [4] G. Heusser, Proceedings 3rd International Summer school on "Low-Level Measurements of Radioactivity in the Environment: Techniques and Applications", Huelva, Spain 1993
- [5] P. Vojtyla, Nucl. Instr. and Meth. In Physics Research B111 (1996)163-170
- [6] Y. Bourlat, Nucl. Instr. and Meth. A339 (1994) 309-317

II. Underground Laboratories

Chairperson: G. Heusser

IRMM LOW LEVEL UNDERGROUND LABORATORY IN HADES

D. Mouchel and R. Wordel

CEC-JRC, Institute for Reference Materials and Measurements (IRMM)

Retieseweg, B-2440 Geel, Belgium

Abstract

The operation of low background HPGe detectors at a depth of 225 m, reduced the background by two orders of magnitude; a large amount of the remaining background is still attributable to the cosmic rays. The selection of radiopure materials, the characterization of reference matrices and the measurements of low radioactivities in environmental samples are performed. Coupling the low level spectrometry with additional techniques, e.g. neutron activation, will allow to measure extremely low radioactivities.

Introduction.

Low radionuclide concentrations in samples were measured at IRMM at the ground level with low level HPGe detectors. Due to radiopure, selected materials and sufficiently low-activity shielding against the environmental radiations, about 98% of the remaining background was attributable to the cosmic rays. Operating the detectors at a depth of 225 m in the High Activity Disposal Experimental Site (HADES) of the Studiecentrum voor Kernenergie (SCK/CEN) at Mol, Belgium, reduces the background by two orders of magnitude and has required the selection of radiopure materials, lead and copper, the removal of radon and the use of an active shield. It is shown that low level HPGe detectors are useful tools to investigate the flux of secondary radiations and radionuclides produced by cosmic rays. Materials selection, characterization of natural reference matrices and low level commercial detectors and material tests in the frame of the Borexino Collaboration are going on. It is aimed to operate soon in HADES a new location specifically designed to measure extremely low radioactivities in materials.

The underground experimental site and the installed equipment

The IRMM low level laboratory [2] is located at the end of a 32 m-long gallery, in the Underground Research Facility (URF) of HADES, Fig. 1. The gallery, lined with 5 cm-thick cast iron segments, has an inside diameter of 3.5 m and was dug out at a depth of 225 m in the upper third of a 100 m-thick clay layer; about 180 m of glauconite soil containing sand covers the clay

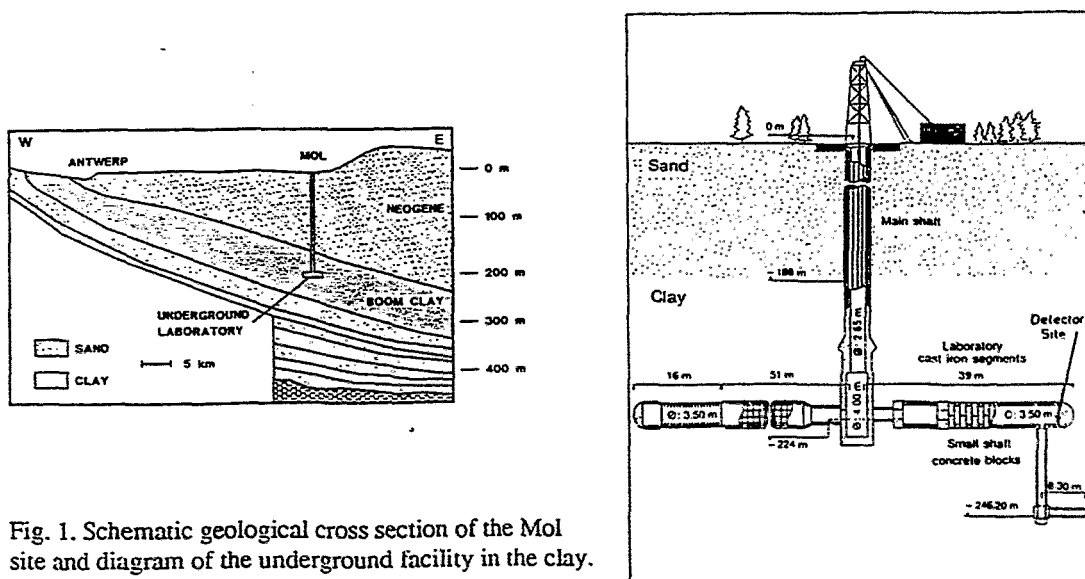

Fig. 1. Schematic geological cross section of the Mol site and diagram of the underground facility in the clay.

layer. It was estimated that this depth corresponds to about 500 m w.e..

Inside the gallery, the air ventilation maintains the radon concentration to about 50 Bq m^{-3} and the resulting exposure rate due to the iron lining and the clay is about 60 nSv h^{-1} . At the depth of 500 m w.e. the nucleonic component of the cosmic radiation is reduced by at least five to six orders of magnitude. The muon flux is reduced by a factor of about 800, compared to ground level and is less than $0.2 \text{ m}^{-2} \text{ s}^{-1}$ (Table 2). Inside the shieldings, it was found that cosmic induced neutron flux was less than $2 \text{ m}^{-2} \text{ s}^{-1}$ for both, thermal neutrons and fast neutrons with energies above 691 keV (Table 2).

At present, three HPGe detection systems, designed with carefully selected low impurity materials, are in operation in HADES, as shown in Table 1.

Table 1. HPGe detectors operating at HADES and the main specifications of their shieldings

Ge volume [cm ³]	Relative efficiency (%)	Shielding material and thickness, [cm]					Background counts s ⁻¹ [5- 2700]keV
		electrolytic copper	lead	²¹⁰ Pb activity. [Bq kg ⁻¹]	lead	²¹⁰ Pb activity [Bq kg ⁻¹]	
100 coaxial	20	6	5 ^a	1	10 ^b	17	0.00666 ₆
40 semiplanar		6	10 ^a	1	5 ^c	700	0.00361 ₄
250 coaxial	60	15 ^d			14 ^e	15	

^a lead originating from old French monuments, ^e from the Hampton Court roof, England.

^b modern lead from the Bolinden company and ^c ordinary lead.

^d freshly produced copper, immediately stored underground to avoid the cosmogenic production of radionuclides, e.g. ^{57,58,60}Co. A fourth, modular shielding, planned to accommodate various types of experiments and built with copper ^d and lead ^e will be soon available.

The U-cryostat configuration is used for each of the detection systems as shown in Fig. 2. The volume around the detector is filled with copper and teflon to reduce as far as possible the radon contamination. Background spectra recorded at the ground level and at -500 m w.e. are shown in Fig.3; a background reduction by two orders of magnitude is achieved.

Fig. 2. Schematic drawing of the semiplanar detection system.

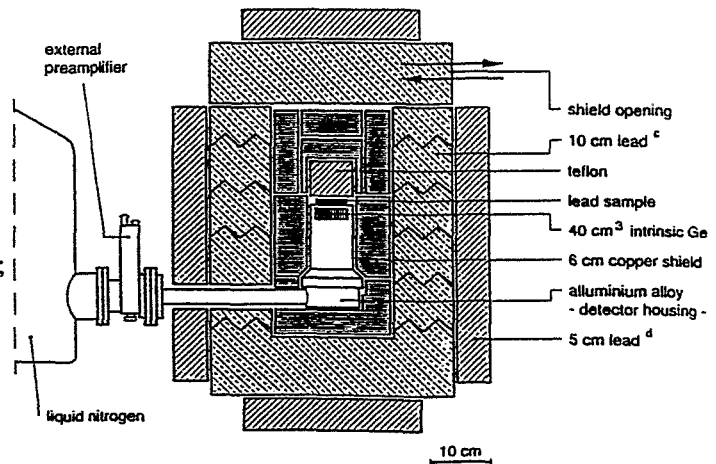

Between $1 \cdot 10^{-2}$ and $2 \cdot 10^{-2}$ events $\text{s}^{-1} \text{ kg}^{-1}$ of Ge are induced within the energy interval 5-2700 keV, about 85% of the background is probably attributable to the cosmic rays. An active background discrimination technique using a multiple detector event by event recording system [3] is applied to distinguish fast muon induced events and radioimpurity events; preliminary results indicate that about 25% of the background events are muon induced. In our set-up for each event an

identification of the detector, the pulse height and the time of occurrence are stored, thus keeping a maximum amount of the available information.

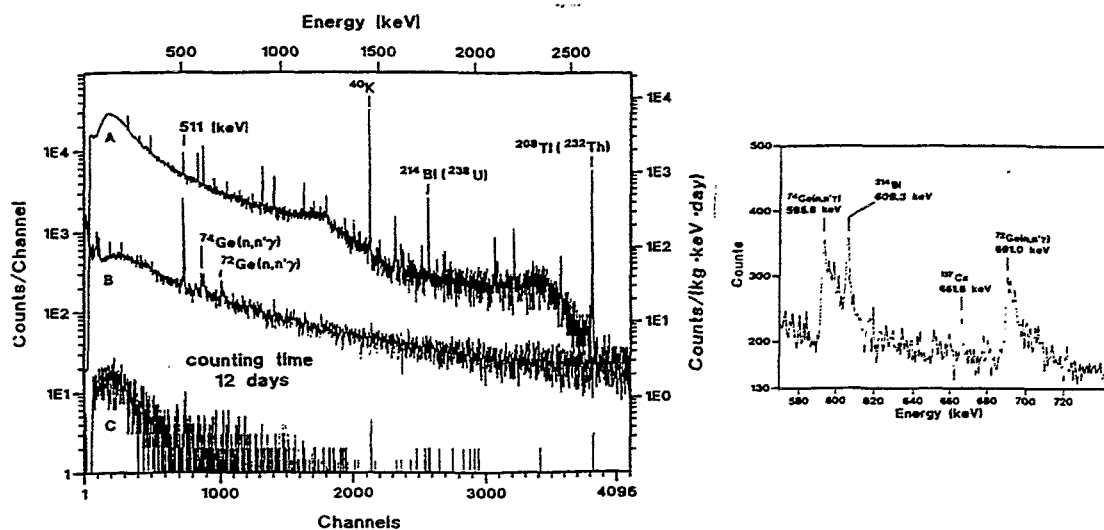

Fig. 3. Background spectra (left) of the 100 cm³ coaxial Ge diode: A in HADES without shielding, B above ground with 15 cm-thick selected lead shielding and C with the shielding described in Table 1. On the right, detail of the spectrum B, shows clearly the cosmic ray induced events in the background.

Study of neutron and muon background in low-level germanium gamma-ray spectrometry

Cosmic ray induced neutrons and muons cause activation of nuclei, in particular within the detector itself and the shielding materials. At the ground level and at -500 m w.e. the fast neutron flux inside the shielding, was deduced from the 691-keV peak intensity resulting from the inelastic scattering of fast cosmic-ray tertiary neutrons on ⁷²Ge (Figure 3) and the thermal neutron flux from the intensity of the 139 keV γ -ray resulting from the environmental neutron activation in ⁷⁴Ge [1]. The muon flux was measured due to their high energy deposition (about 6 to 8 MeV per traversed cm of Ge) inside the detector [1]. From 1985 to 1992 many background spectra were recorded with the 100 cm³ Ge diode at ground level. A variation of the fast and thermal neutron flux was observed and found in good agreement with the neutron flux data of the Kiel Neutron Monitor, measured during this period [1]. The results (Table 2) contributed to optimize the design of the shieldings according to the quality and the amount of the materials used.

Table 2. Muon and neutron fluxes, (m⁻² s⁻¹), at our experimental sites

	fast neutrons E _{neutron} > 691 keV	thermal neutrons	muons
IRMM (15 m above sea level)	140-250	10-50	140-180
HADES (-500 m w.e)	< 2	< 2	< 0.2

Applications and achievements of low level counting at IRMM

Until the end of 1992, two detectors were operated at the ground level laboratory at IRMM. The measurement of natural and anthropogenic radionuclides has been made in environmental samples, in particular in aquatic plants chosen as bioindicator [4] and in soil and river sediments [5]. The fall-out from the Chernobyl accident, e.g. ^{134}Cs , ^{137}Cs , and weak contamination from industrial sites, e.g. ^{60}Co , ^{226}Ra , were observed. The detection limits (D.L.) of $10^{-2} \text{ Bq kg}^{-1}$ of sample for ^{134}Cs and ^{137}Cs , $10^{-1} \text{ Bq kg}^{-1}$ for ^{60}Co and of $10^{-1} \text{ Bq kg}^{-1}$ for ^7Be were determined. An investigation of the natural radioactivity of volcanic rock samples [6] aimed to date the magma generation; a breaking of the secular equilibrium was observed. Measurement of the concentration of natural radionuclides in a Manchester clay standard, used as a reference material in archeometry, was done.

Since 1993 the detectors are operating at -500 m w.e.; radiopure material selection is a basic task to operate low level detector systems, mainly underground. Measurement of ^{210}Pb activity of ancient and modern lead has been made, the results are shown in Table 3. ^{210}Pb activities of a few tens of mBq kg^{-1} and higher can be measured.

Table 3. Activity concentration of ^{210}Pb , Bq kg^{-1} , in lead samples,

a	b	c	d	e	f	g	h	i
29 ± 3	8 ± 2	230 ± 12	293 ± 15	693 ± 32	14 ± 2	2.4 ± 1.3	< 1	70.1 ± 1.4

a, b, c, d, selected, commercial available lead batches; e ordinary lead.

f, g, ancient lead from English and French monuments, used in our shieldings; h Etruscan sample.

i reference sample from PTB.

The HADES facility has been used to measure the ^{210}Pb decay rate in nutritious fluid of human lung cells, to characterize the background components of a 480 cm^3 HPGe diode, to participate in an international effort to characterize a natural matrix reference material (bone ash), to investigate the flux of secondary radiation and radionuclides produced by cosmic rays. As member of the Borexino Collaboration since this year, we are involved in the tests of the materials for the Borexino detector.

Future at HADES

It is aimed to operate soon in HADES a new location especially designed to measure extremely low radioactivities in materials. Technical improvements have to be implemented such as a dedicated power line, proper ventilation for the radon reduction and selected low activity wall material. The measurement room will be separated from the main gallery by a dusttight prechamber. There will be space to operate six counting systems.

References.

- [1] R. Wordel, D. Mouchel, T. Altitzioglou, G. Heusser, B. Quintana and P. Meynendonckx, Nucl. Instr. and Meth. A 369 (1996) 557.
- [2] R. Wordel, D. Mouchel, A. Bonne, P. Meynendonckx and H. Vanmarcke, Proc. 3rd Int

Summer School on Low-Level Measurements of Radioactivity in the Environment: Techniques and Applications, Huelva, Spain, 1993, eds. M. García-León and G. Madurga (World Scientific, Singapore, 1994) p. 141.

[3] R. Wordel, D. Mouchel, E. Steinbauer and R. Oyrer, to be published in Appl. Radiat. Vol. 1966.

[4] D. Mouchel and R. Wordel, Appl. Radiat. Isot. Vol. 43, No 1/2 pp 49-59, 1992.

[5] D. Mouchel and R. Wordel, 3rd Int. Summer School on Low-Level Measurements of Radioactivity in the Environment: Techniques and Applications, Huelva, Spain, 1993, eds. M. García-León and G. Madurga (World Scientific, Singapore, 1994) p. 315.

[6] R. Wordel, D. Mouchel, V.A. Solé, J. Hoogewerff and J. Hertogen, Nucl. Instr. and Meth. A 339 (1994) 322.

LOW BACKGROUND GE SPECTROMETRY AT GRAN SASSO UNDERGROUND LABORATORIES

*Werner Preusse, Carlo Bucci and Cristina Arpesella**

Istituto Nazionale di Fisica Nucleare - Laboratori Nazionali del Gran Sasso

**)presently: Institut National de Physique Nucleaire et de Physique des Particules IN2P3 -
Centre de Physique des Particules de Marseille*

Under the shelter of 1400 m limestone rock the Gran Sasso underground laboratories in the Apennines (110 km north-east of Rome at a turn-off inside the Gran Sasso motorway tunnel) were designed for running large experiments in the field of neutrino, particle and astrophysics by international collaborations. These experiments have in common the basic requirement to be capable to detect very rare events like e.g. neutrino interactions and double beta decays. Due to this their permanent demands for selecting radiopure materials have led to the equipping of a Ge detector laboratory - at present with 6 large detectors.

Of course also the Ge spectrometers profit particularly from the almost complete absorption of cosmic rays in the rock. The mean vertical depth of 3800 m.w.e. reduces the muon flux by 6 orders of magnitude down to 0.7 muon per m^2h [1]. This corresponds to a few counts per week recently measured with a large 500 cm^3 Ge as well as with a 600 cm^3 NaI detector in the energy range above 10 MeV resulting in the same suppression factor of 10^6 compared to the 1 cps from direct muon events measured with a similar NaI above ground [2]. The threshold energy for muons penetrating from the atmosphere is about 1000 GeV. The underground neutron flux is not dominated by cosmic ray produced neutrons but by those from fission and (α, n) reactions in the rock. The resulting flux is about $40\text{ m}^{-2}\text{h}^{-1}$ for thermal and $140\text{ m}^{-2}\text{h}^{-1}$ for all neutrons [3], i.e. 3 orders of magnitude lower than that one on earth's surface at sea level. Therefore deexcitation gammas following neutron capture and inelastic scattering in germanium and the construction material copper are not detectable in the Ge background spectra.

Because of the practically complete absence of cosmic ray induced components the other background sources are of special importance in a deep underground laboratory. The total gamma flux from the surrounding limestone rock is about $1\text{ cm}^{-2}\text{s}^{-1}$ [4] and originates from 1 ppm uranium, 0.1 ppm thorium and 200 ppm potassium in the rock [5]. Changes of the external gamma radiation at different places in the underground lab. are of course caused by the materials of buildings and the technical equipment. The Ge detectors (not considering here those of the Heidelberg-Moscow ^{76}Ge $0\nu\beta\beta$ decay experiment being also in the Gran Sasso lab.) are located in a separate container box. The Radon concentration fluctuates around 10 Bq/m^3 in this regularly ventilated room while outside the Ge box the value is higher (e.g. average 50 Bq/m^3 in 'hall C' where the same air, $35000\text{ m}^3/\text{h}$ for the whole lab., from outside the tunnel is blown in [6]). The various measures (massive shield, Rn expelling) to reduce the detector backgrounds are compiled in a table (next page) together with detector data and resulting background count rates. Worth mentioning here is the effect of a recently applied 2 cm Roman lead innermost shield ($< 20\text{ mBq}^{210}\text{Pb/kg}$! [7]) improving the integral background count rate from 0.67 cpm (measured with a complete OFHC copper shield as used for the other Ge detectors) to 0.49 cpm for the detector named GePaolo. Until now only two of the detector shieldings are covered by acrylic glass boxes which are flushed with nitrogen under excess pressure. Doing this the background lines of the ^{222}Rn daughters are reduced by a factor of 2 compared to the previous situation with simple nitrogen flushing inside the shield which is covered only by a plastic film.

DETECTOR - name - company - year - type	GS1 PGT - 1989 coaxial p-Ge	GeMi Ortec - 1990 coaxial p-Ge	GeBer Ortec - 1993 coaxial n-Ge	GePaolo Ortec - 1993 coaxial p-Ge	GS2 Ortec - 1992 coaxial p-Ge	GePv Ortec - 1991 coaxial p-Ge
REL. EFFICIENCY / FWHM at 1.33 MeV :	62 % / 2.3 keV	85 % / 1.9 keV	53 % / 2.1 keV	113 % / 2.0 keV	94 % / 2.0 keV	91 % / 1.8 keV
ENDCAP :	1.5 mm Cu	0.5 mm Cu	Cu/carbon fiber	1.5 mm Cu	1.5 mm Cu	1.5 mm Cu
SHIELD : - Pb (< 30 Bq ²¹⁰ Pb/kg) : - innermost :	20 - 25 cm 7 cm OFHC-Cu	20 - 25 cm 7 cm OFHC-Cu	20 - 25 cm 7 cm OFHC-Cu	20 - 25 cm Pb, 5 cm OFHC-Cu, 2 cm Roman Pb	20 - 25 cm 7 cm OFHC-Cu	20 - 25 cm 7 cm OFHC-Cu
RADON expelling : - N ₂ -flushing	from LN ₂ -dewar	from LN ₂ -dewar	from LN ₂ -dewar	excess press. in acrylic glass box	excess press. in acrylic glass box	from LN ₂ -dewar
BACKGROUND (50 - 2700) keV	(cpm) 0.57	(cpm) 1.1	(cpm) 3.3	(cpm) 0.49	(cpm) 0.96	(cpm) 0.82
(100 - 500) keV	0.39	0.76	2.2	0.32	0.60	0.57
46.5 keV (²¹⁰ Pb)	0.0005	0.0014	0.026	0.015	0.013	0.0011
63.3 keV (²³⁴ Th)	< 0.0009	0.001	0.009	< 0.0006	< 0.0015	< 0.0007
186 keV (Ra/ ²³⁵ U)	0.0015	0.0026	0.006	< 0.0006	< 0.001	0.0015
352 keV (²¹⁴ Pb)	0.0013	0.010	0.005	0.0025	0.0046	0.0078
511 keV (²⁰⁸ Tl/e ⁺ e ⁻)	0.0012	0.0022	0.0018	0.0010	0.0025	0.0010
583 keV (²⁰⁸ Tl)	< 0.0006	0.0040	0.0015	0.0010	0.0025	0.0026
661 keV (¹³⁷ Cs)	0.0035	0.0034	0.0006	0.0011	0.0044	0.0006
911 keV (²²⁸ Ac)	< 0.0004	0.003	0.001	0.0006	0.001	0.002
1333 keV (⁶⁰ Co)	0.0054	0.003	0.005	0.0014	0.0017	0.0046
1461 keV (⁴⁰ K)	0.0034	0.010	0.004	0.0023	0.006	0.0047
1764 keV (²¹⁴ Bi)	0.0003	0.0022	0.0006	0.0005	0.0012	0.0015
2615 keV (²⁰⁸ Tl)	0.0005	0.0025	0.0006	0.0006	0.0015	0.0013
conspicuous :	¹²⁵ Sb lines !	²²² Rn daughters !	Uranium !	²¹⁰ Pb !	^{57,58} Co, ⁵⁴ Mn, ⁶⁵ Zn!	²²² Rn daughters !

different background spectra of GePaolo

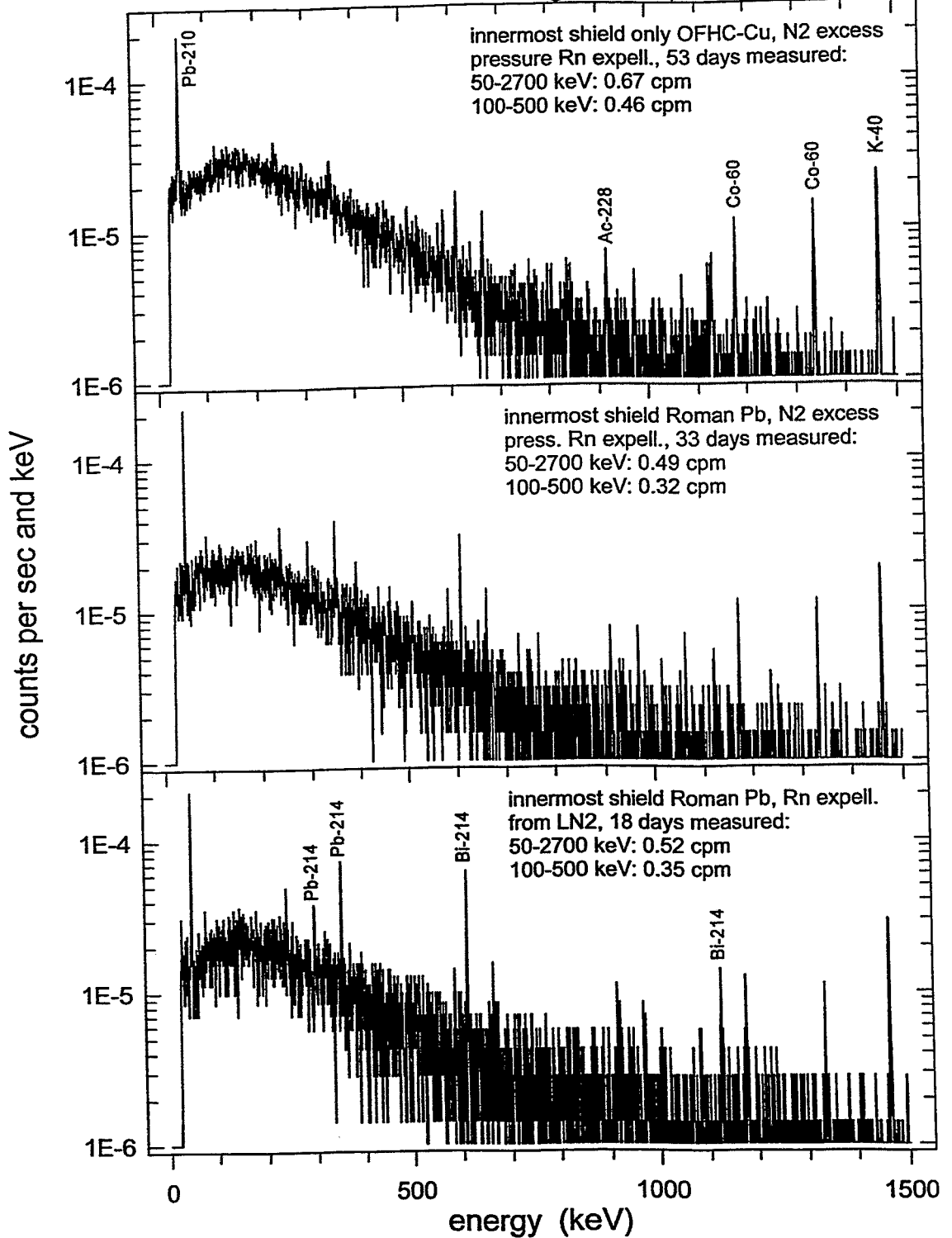

The background spectra of the different detectors (using here our internal names also given in the table) show some interesting details to be shortly discussed here. The integral count rate is 1 cpm or less for each of the p-type Ge's. In general the residual lines are caused by internal contaminations within the detectors themselves and by not completely removed radon (lines of ^{214}Pb and ^{214}Bi) in small cavities in the shield. The detector GS1 shows still strong ^{125}Sb ($T_{1/2} = 2.73$ y) lines although they are reduced down to less than 20 % compared to the situation in 1990 when the internally contaminated detector was new. GeMi and GePv are mainly suffering from radon daughters, a situation which will be improved by applying a radon expelling like for GePaolo. GeBer (the only n-type detector) has a higher total background than the others while the peak count rates (except for low energies and the 186 keV line) are similar or even better. An internal uranium contamination and the unfortunately used indium are the main problems of this detector. GePaolo is the largest and in a certain sense also the best detector. But its relatively high internal ^{210}Pb contamination should be responsible for a part of the total background due to bremsstrahlung of the ^{210}Bi -betas. As an example the plotted spectra on the previous page show the background of GePaolo under different shielding conditions. GS2 has brought back a number of activation products from its repair trip to the U.S. last year. So we will be unfortunately able to observe ^{57}Co , ^{58}Co , increased ^{60}Co , ^{54}Mn and ^{65}Zn and their decay in the next years.

The Ge counting for the Gran Sasso underground experiments comprise samples like scintillator liquids, PMT components, materials for detector construction (steel, copper, plastic etc.), electronic device parts (capacitors, resistors etc.), building materials (cement, sand) and various other things (e.g. chemical substances, glue). Often it has to be proven that upper limits of contaminations are not exceeded or which out of different material variants is preferable from the point of view of radiopurity.

Measurements of direct physical interest are performed for detecting double beta ($2\nu\beta\beta$) decays to excited states of the daughter nucleus. In this case deexcitation gamma quanta can be counted by Ge detectors with sufficiently low background. Because of the direct connection of the $2\nu\beta\beta$ half live to nuclear matrix elements its determination or at least limitation tests nuclear structure models very sensitively and improves therefore also the theoretical basis for investigations of the neutrinoless double beta ($0\nu\beta\beta$) decay. Currently a search for the $2\nu\beta\beta$ decay of ^{150}Nd is performed on two Ge detectors (GS1 and GS2). GS2 is counting a sample of 6185 g natural neodymium (5.64% ^{150}Nd) for more than 5 months looking for the deexcitations lines (^{150}Sm levels) at 406.47 keV ($0_2^+ \rightarrow 2_1^+$) and 333.95 keV ($2_1^+ \rightarrow 0_{g.s.}^+$). This cascade is more sensitively searched also by running GS1 in coincidence with a NaI and recording multiple event vectors with a CAMAC system.

To improve the capability of the Gran Sasso Ge detector lab. to measure extremely small radioactive contaminations a new detector made from specially selected materials is under construction at Canberra Semiconductor N.V. in these weeks.

References

- [1] S. P. Ahlen et al., Phys. Lett. **B249/1** (1990) 149
- [2] W. Preusse and S. Unterricker, Nucl. Instr. Meth. Phys. Res. **B94** (1994) 569
- [3] P. Belli et al., Il Nuovo Cimento **A101** (1989) 959
- [4] C. Arpesella, Nucl. Phys. B **28A** (1992) 420
- [5] C. Arpesella in: R. Bernabei and Ch. Tao (ed.) 'The dark side of the universe', World Scientific 1994
- [6] C. Arpesella et al., INFN report LNGS-94/105
- [7] A. Alessandrello et al., Nucl. Instr. Meth. Phys. Res. **B83** (1993) 539

Low-level counting techniques in the underground laboratory "Felsenkeller" in Dresden

S. NIESE, M.KÖHLER

Nuclear Engineering and Analytics Rossendorf Inc.,

P.O.Box 510119, D-01314 Dresden, Germany

1. Introduction

Low radioactivity measurements are characterized by low detection limits. They are mainly determined by the background. The contribution of cosmic rays may be reduced drastically by installation of measurement devices in an underground laboratory. In 1982 we installed a chamber with a shield of ultramafic rock for low-level measurements within a cave of an old brewery named "Felsenkeller" (Helbig,1984). In this laboratory we used low-level γ - spectrometry for the measurement of neutron activated samples of semiconductor silicon (Niese(1986)), of cosmic induced radioactivity in meteorites, chemically separated long-lived nuclides in low-level wastes, contaminated materials and of environmental samples. On the contrary to our underground laboratory concept the measurement of rare nuclear events is possible only at extremely low background which needs rock covering of more than 1000m. This is presently performed in mines (Brodzinski,1988) and tunnels (Heusser,1993; Reyss 1995).

2. The underground laboratory "Felsenkeller" in Dresden (FK)

The underground laboratory "Felsenkeller" is located at normal traffic level within a cave of an old brewery in the Weisseritz-valley in Dresden. By a 45 m rock cover 98% of cosmic muons are shielded. The remaining 2% may be further reduced by an active anticoincidence shield. The underground laboratory contains a measuring chamber shielded by steel and lead. The length, width and height are 6, 3 and 2.2m, respectively. The shielding consists from outside to inside of 10mm new steel, 270mm granulate of hard steel, 36mm old steel, 30mm lead and 12 mm old steel. The specific surface density amounts to 210gcm^{-2} . The detectors themselves are shielded separately with 10-17 cm lead.

In the underground laboratory the rock consists of hornblende monzonite with contents of K, Th and U of 5%, 50 ppm and 12 ppm, respectively. This corresponds to activities of ^{40}K , ^{208}Tl , and ^{214}Bi of 1300, 72, and 140 Bq/kg, respectively. In order to shield the high energy radiation of the 2615 keV line of ^{208}Tl , a daughter of Th, a metallic shield with an attenuation equivalent to 33

cm lead is necessary to reduce the radiation to such an intensity that with a 30% Ge-detector within a counting interval of two weeks only one count will be registered.

The activity of ^{222}Rn in the cave amounts to about 200 Bq/m^3 , therefore we introduce heated fresh air from outside (40 Bq/m^3) into the laboratory. The evaporated nitrogen from the kryostate is used to replace the radon containing air within the shielding of the detector.

3. Measurement of materials used for building, shielding and installations

Before constructing the low-level measurement equipment we calculated the maximum permissible activity for each of the materials to be used for building, shielding, construction, installation and detector. We measured the radioactivity and calculated their contribution to the measured background. The total contribution of the activity of all materials for shielding, corrosion protection, and installation should not exceed 0.3 count per 14 days to the 2615 keV peak or to any other peak.

Because of the fact, that the activity of all tested commercial paintings for corrosion protection exceed the allowed value of specific activity, we used a special mixture of selected pigments like talkum, iron oxide and zinc powder.

4. Measured background

Gamma spectrometry

The background measured with a 30% HPGe well-typ detector in our laboratory is reduced by a factor of about 50 in comparison with above ground installations. In comparison with results from the underground laboratory in Mol, which is located in a clay layer in 225m depth our background is higher by a factor of about 10 (Wordel,1993). The main contribution of the remaining background in the gamma spectrometry are caused by neutrons from the cosmic rays and the surrounded rock. We have compared the intensity of peaks in the background spectra measured in our laboratory caused by reaction products of neutrons with the results obtained in a well shielded laboratory above ground in the Physikalisch-Technische Bundesanstalt Braunschweig (Kolb,1992). From this we estimated a reduced neutron flux only by a factor of about 13 whereas the muon flux is reduced by a factor of 45.

Liquid scintillation counting

The background of the liquid scintillation spectrometer (Type Quantulus, Wallace) is very low

above ground because of his thick lead shielding and his efficient anticoincidence guard detector. After installation in the underground laboratory its background was not reduced remarkable. We assume that the main contribution must be caused by the material of the spectrometer itself e.g. of the PMT.

Beta gamma coincidence spectrometry

With an equipment for β,γ - coincidence spectrometry consisting of a 4"x3" NaI crystal and seven plastic detectors placed at the front of the NaI crystal we had demonstrated that the low background of the β,γ - coincidence spectrometry at the laboratory above ground was further reduced in the underground. The investigation of the background in β,γ - spectrometry was the reason for us to start experiments in the underground.

5. Samples to be measured in the underground laborator

We are measuring solid samples of materials with low specific activity, original or evaporated liquid samples and chemically isolated fractions prepared for alpha, beta or gamma spectrometry. The shielding of the measuring room enables us to measure large samples which cannot be placed within the special detector shielding. This has been demonstrated in whole body counting and the measurement of the radioactivity of a complete equipment. To use the advantage of low background in the measurement, equivalent efforts should be done in preconcentration and radiochemical purification of the measuring samples. This include the evaporation of large volums of water samples and the separation of radionuclide fractions.

Conclusions

The underground laboratory "Felsenkeller" is well suited for the measurement of low radioactivity in different types of sample series. The main advantages are

- Background reduction by two orders of magnitude enables significant improvements of detection limits
- The horizontal cave allows us easy transportation of samples, equipments, and personal.
- Acceptable distance to the laboratories in Rossendorf
- Incorporation in an analytical department enables combination of radioactivity measurements with other methods

- The R&D program of the VKTA secure the further application and development of low-level counting techniques

Because of the moderate thickness of the rock cover the laboratory is not suitable for fundamental physical experiments where an extremely low muon flux is necessary.

Aknowledgement

The federal ministry of education and researh (BMBF) and the Saxonian ministry of sciences (SMWK) and arts has given the financial support necessary for development and construction of the laboratory. Dr. Uhlmann from the SMWK has given especially attention to each significant event connecting the laboratory. The former director of the VKTA Professor Häfele has done such decisions, so that we could obtain a nice laboratory in a very short time. A. Richter from the VKTA adminstration has done so much to free us from bureaucracy and W. Siemes organized the co-operation with and between the different frameworks. Experiences with the first measuring chamber were collected in cooperation with W. Helbig, W. Görner, D. Birnstein. Birgit Gleisberg was responsible for the chemical isolation of the nuclides and H. Schmidtke has measured a large number of samples. M. Bothe has organized such measures that preparation, measurement and mailing of results of the samples were running in time and has discussed with us a lot of details. Ingrid Schäfer performs the measurements with the LSC.

The new measuring chamber was built by the firm "Antitron". Mr. Saleti was much engaged to fullfil our extreme restrictions in low radioactivity of shielding and construction materials. Dr. Fink from the Farbenwerk Erfurt has mixed paintings for corrosion protection using substances of low specific radioactivity.

References

- Brodzinski R. L., Reeves J.H., Avignone III, F.T., Miley M.S. (1988) Achieving Ultralow Background in a Germanium Spectrometer, *J. Radioanal. Nucl. Chem., Articles*, **124** 513 - 521,
- Helbig W., Niese S., Birnstein D. (1984) Untergrundlaboratorium für die Messung geringer Radioaktivität, *Isotopenpraxis* **20**, 60 - 64
- Heusser G.(1993) Background in ionizing radiation detection-illustrated by ge-spectrometry,

Proc. 3rd Intern. Summer school on Low-Level Measurements of Radioactivity in the Environment : techniques and applications, Huelva, Spain

Kolb W. (1992) Meßanleitung Umweltradioaktivität, 1.Lfg. Gammasp/Nulleff, Gustav-Fischer-Verlag- Stuttgart-Jena 1992

Niese S., Helbig W.(1986) Detection Limits in Activation Analysis Using Ge(Li)-Detectors Installed in an Underground Laboratory, J. Radioanal. Nucl. Chem., Articles **100**, 155 - 163

Wordel R., Mouchel D., Bonne A., Meynendonckx P., Vanmarcke H. (1993) Proc. 3rd Intern. Summer school on Low-Level Measurements of Radioactivity in the Environment

III. Design of Low-Level γ -Spectrometers

Chairperson: S. Niese

TWO LOW-LEVEL GAMMA SPECTROMETRY SYSTEMS OF THE IAEA SAFEGUARDS ANALYTICAL LABORATORY

J. L. Parus, W. Raab, D. Donohue, V. Jansta, J. Kierzek*

IAEA SAL, Wagramerstrasse 5, A-1400 Vienna, Austria

Gamma spectrometers

A gamma spectrometry system designed for the measurement of samples with low and medium radioactivity (activity from a few to about 10^4 Bq in the energy range from 25 to 2700 keV) has been installed at the IAEA Safeguards Analytical Laboratory in Seibersdorf. The system consists of 3 low level detectors:

- 1) n-type coaxial Ge with 42.4% relative efficiency, 1.85 keV FWHM at 1.33 MeV
- 2) planar Ge with 2000 mm² area and 20 mm thickness, 562 eV FWHM at 122 keV
- 3) NaI(Tl) annulus of 25.4 cm diameter and 25.4 cm height, hole diameter 90 mm.

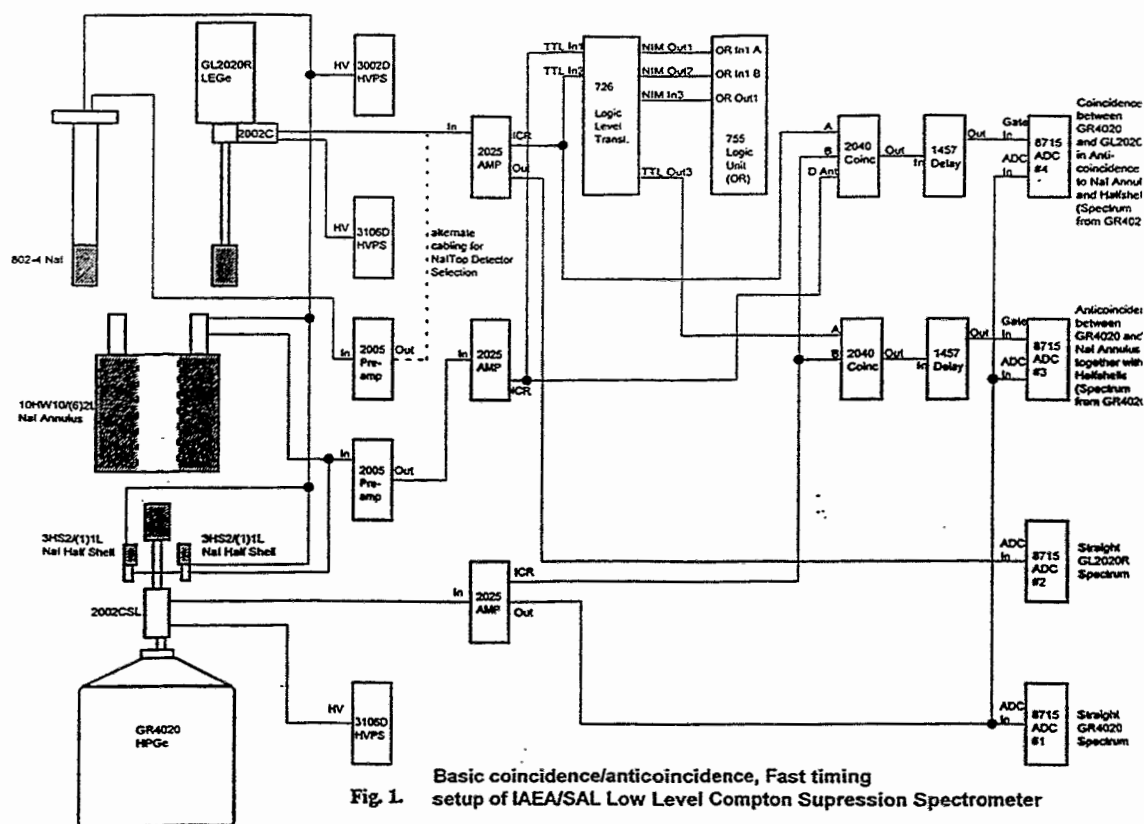

Fig. 1.

* on leave from Institute of Nuclear Chemistry and Technology, Dorodna 16, 03-195 Warsaw, Poland.

The block diagram of the system is shown in Fig. 1. The 2 Ge detectors are placed vertically along a common axis and can be precisely moved in the NaI(Tl) annulus. The planar Ge detector can be replaced by a 3 x 3" NaI(Tl) plug detector. The results which we present here were obtained with a simplified system shown in Fig. 2.

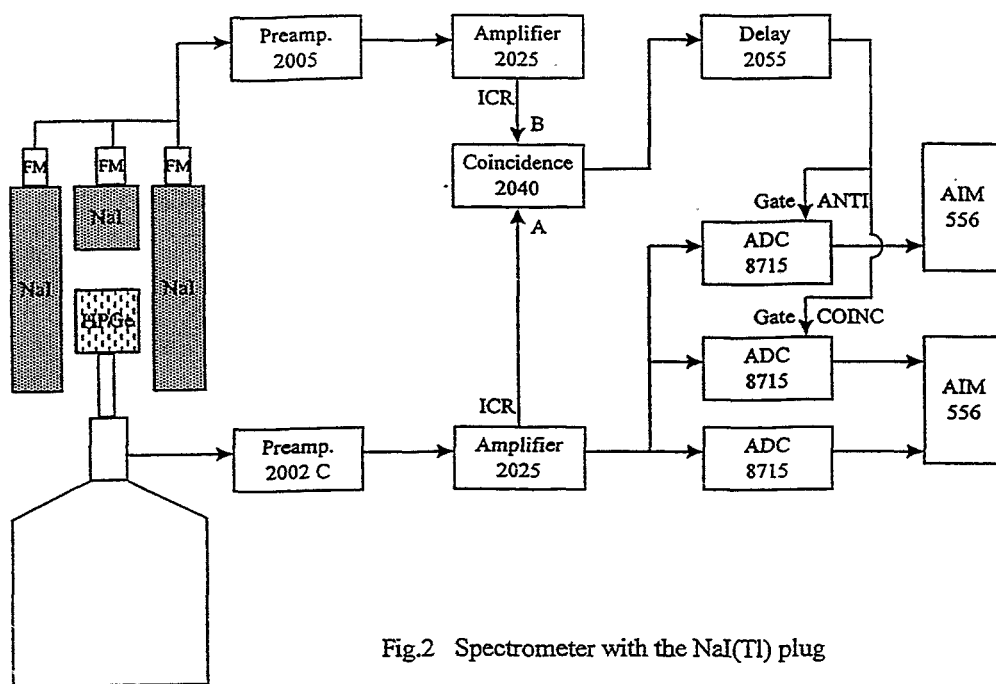

Fig.2 Spectrometer with the NaI(Tl) plug

The pulses from the NaI(Tl) annulus and plug detectors adjusted to equal gain are fed to a common preamplifier. The output pulses from a fast amplifier-discriminator of the 2025 main amplifier (incoming count rate - ICR), normally used for pile-up rejection are sent to a coincidence unit whose output is used for gating the 2 ADC in anti- and coincidence modes. In this way 3 gamma spectra: normal, anticoincident and coincident are simultaneously accumulated.

The second gamma spectrometer, installed in a clean laboratory environment has a low level, extended range, p-type Ge detector of 90% counting efficiency and a 15-position automatic sample changer. This spectrometer is designed for the measurement of low activity samples. Both spectrometers have identical cylindrical lead shields of 100 mm thickness. The ^{210}Pb activity of the lead is about 1 Bq kg $^{-1}$.

Compton-suppressed spectra

Fig. 3 shows the normal and anticoincident spectra of a point ^{137}Cs source placed 5 mm above the coaxial Ge detector window. In Table 1 the performance data for this source are summarized. The peak to Compton ratio in the anticoincidence spectrum at the Compton edge is 710:1. The counting loss in the full energy peak of 661 keV is less than 1%. The Compton-suppression is effective above 25 keV in energy.

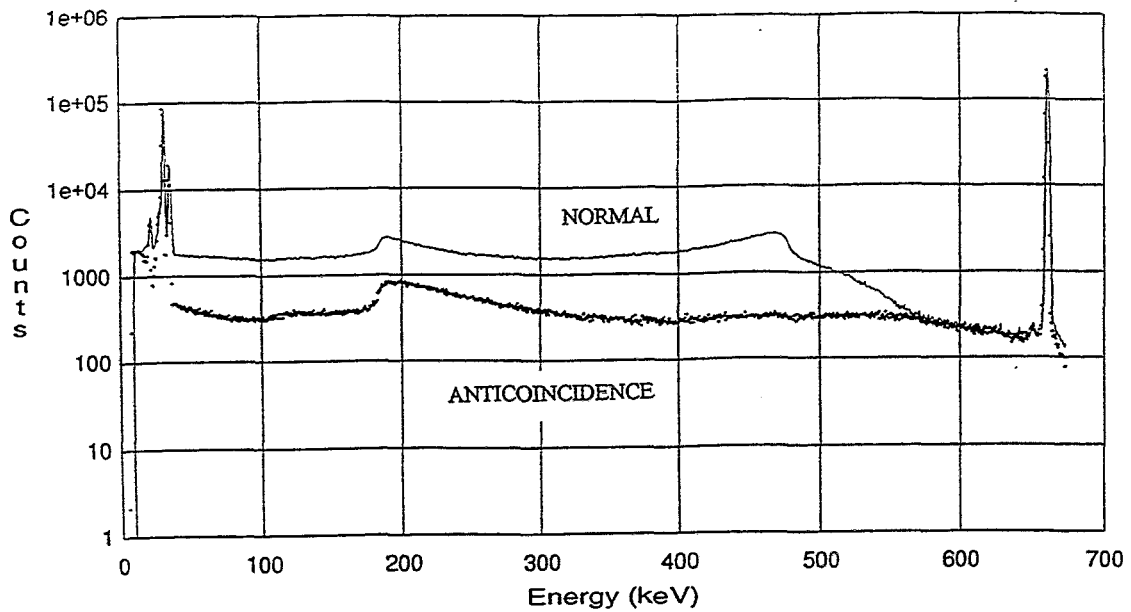

Fig. 3. Normal and anticoincidence spectra of a Cs-137 point source.
Measurement live time 2000 sec.

Table 1. Summary of Compton-suppression performance for ^{137}Cs point source.

	P/C_{60}	P/C_{pl}	P/C_e	A_p/A_T
Normal spectrum	129	132	79	0.28
Suppressed spectrum	581	756	710	0.62
Improvement factor	4.5	5.7	9.0	2.2

where:

- P - full energy peak height, counts
- C_{60}, C_{pl}, C_e - average number of counts per channel for energy ranges 55 to 65 keV, 358 to 382 keV (Compton plateau) and 461 to 472 keV (Compton edge), respectively
- A_p - 661 keV peak area, counts
- A_T - total area of spectrum, counts.

In Fig. 4 there are the normal and anticoincidence spectra of a ^{60}Co point source. The Compton-suppression factors for several energies are shown. The Compton suppression is efficient above 25 keV energy. The full energy peaks of 1.17 MeV and 1.33 MeV are reduced in the anticoincidence mode by factors of 4.2 and 4.5 respectively.

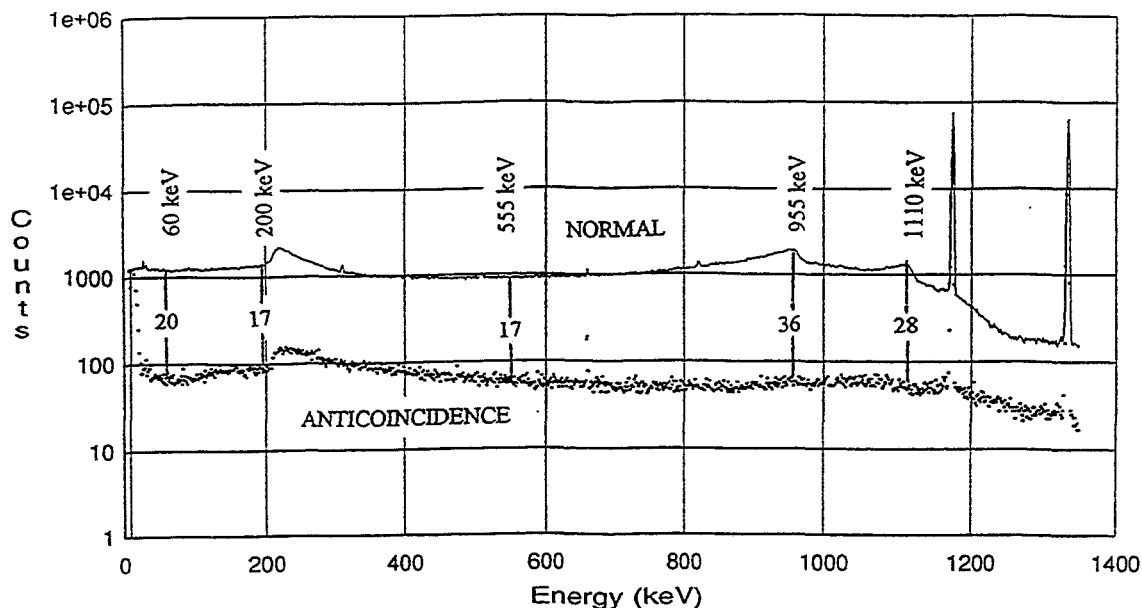

Fig. 4. Normal and anticoincidence spectra of a Co-60 point source. Measurement live time 2000 sec.

The coincidence spectra, not shown in Fig. 3 and 4, are complementary to the anticoincidence spectra. The algebraic sum of these two spectra gives within $\pm 0.5\%$ the normal spectrum.

Measurements of background

The background was measured for both spectrometers in a normal gamma spectrometry mode in approximately 2.5×10^5 sec covering the energy range from 10 keV to 2.7 MeV. The background is 2.7 cps and 1.3 cps for the 90% and 42% Ge detectors, respectively. This corresponds to reduction factor of about 250 in comparison to the background without the lead shielding.

Fig. 5 shows the normal and anticoincidence background spectra of the 42% Ge detector as well as the normal spectrum of the 90% Ge detector. The anticoincidence mode further reduces the background by a factor of about 6 to 0.2 cps which gives a total reduction factor of about 1200. This compares favorably with similar systems described elsewhere (1.2). The background coincidence spectrum shows practically no other peaks except 511 keV.

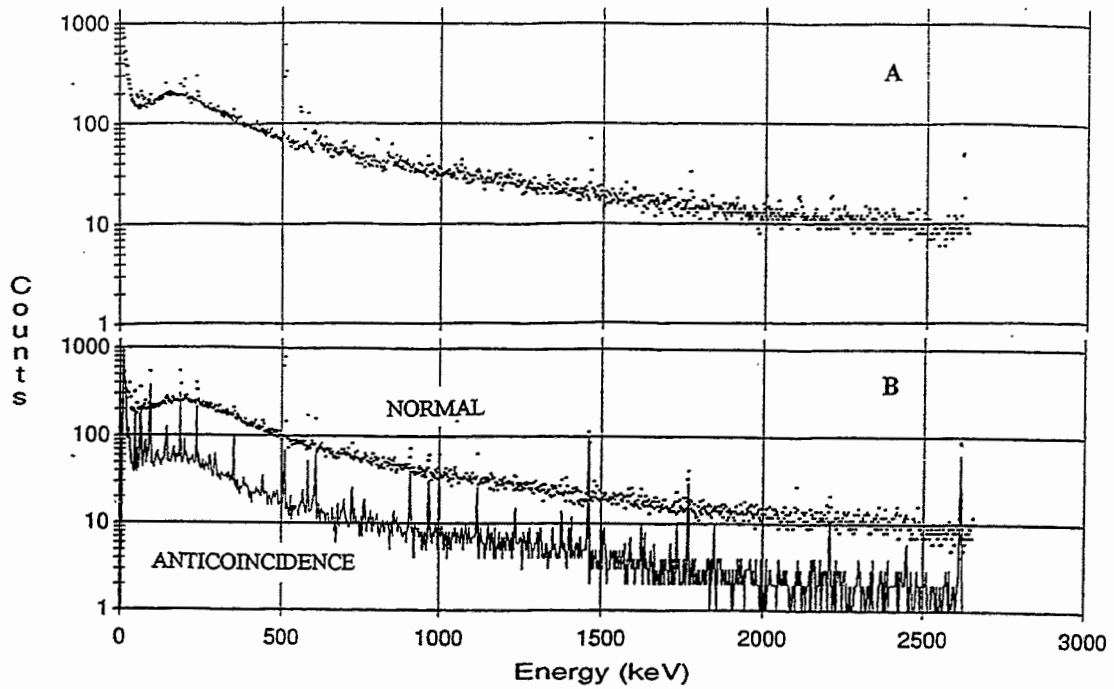

Fig. 5. Spectra of the natural background. A - Normal for the 90% HPGe detector
 B - Normal and anticoincidence for the Compton suppression spectrometer

References

- 1) A. Adam, J. Laurec, G. LePetit, Determination de tres faibles activites a l'aide de spectrometres gamma a faible bruit de fond equipes d'un systeme anticosmiques, Journées de Spectrométrie gamma et X. Oct. 1993, p. 309-313.

DESIGN AND APPLICATIONS OF AN ANTICOINCIDENCE SHIELDED LOW BACKGROUND GAMMA-RAY SPECTROMETER

Hermann Petri

*Research Center Jülich GmbH (KFA)
Central Department for Analytical Chemistry (ZCH)*

A low background gamma-ray spectrometer has been constructed for measuring artificial and natural radioactive isotopes. The design of the spectrometer, its properties and the application to the determination of natural radioactivity of dental ceramics are described.

1. Design

The low-level laboratory is situated in the basement of a three story building. Fig. 1 is a sketch of the radiation shield containing two chambers, the interior dimensions are 90 cm wide and high. The heavy shielding consists of lead (10 cm) and electrolytic copper (8 cm) lined with acryliclas (1 cm). The shield is covered with cadmium serving as neutron catcher.

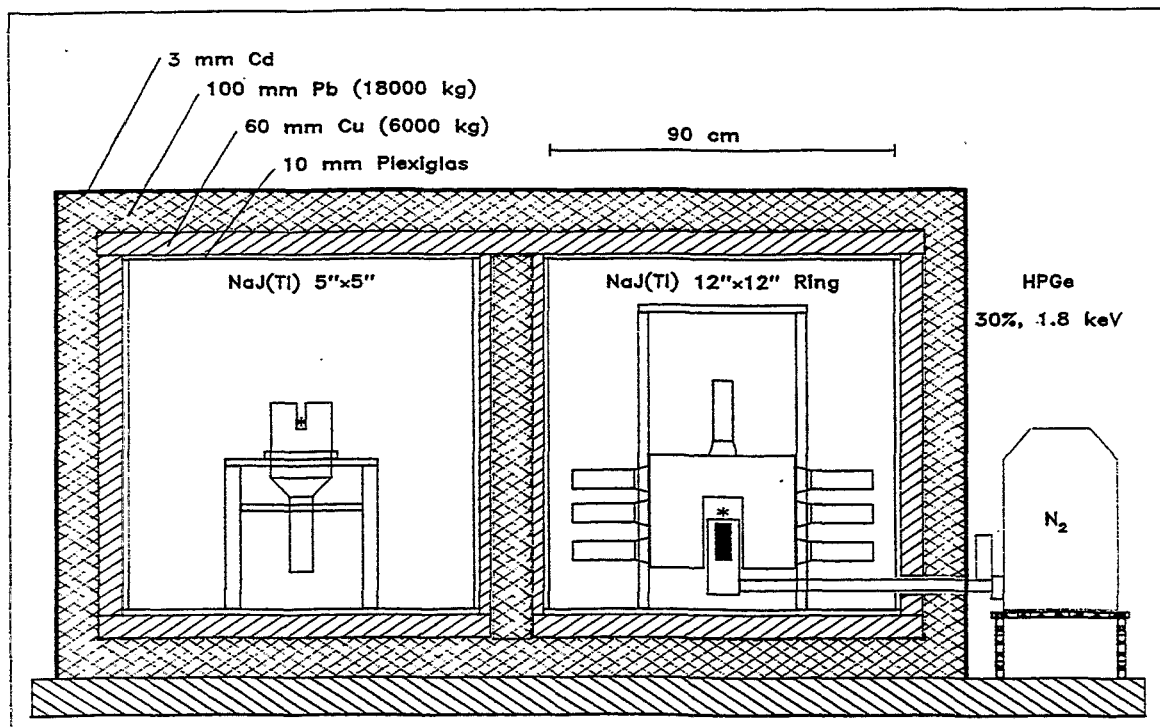

Fig. 1. Diagram of the Ge-NaI(Tl) anticoincidence gamma-ray spectrometer

This paper deals with the detector system of the right chamber, a high pure Ge-detector mounted on a horizontal cryostat (30% rel. Efficiency, 1.9 keV FWHM at 1332 keV) is surrounded by a 12"x12" NaI(Tl) crystal serving as a guard detector. The annulus consists of two halves and a plug coupled to 13 multiplier tubes. Particular attention was paid to the radioactivity content of all materials used inside the shielding by measuring them with an older low-level system.

An anticoincidence system with sample inside the annulus suppresses not only the Compton background but also coincident gamma lines. The electronics is therefore designed to gather the anticoincident and the „normal“ or unsuppressed spectrum providing improved sensitivity for both coincident and noncoincident gamma-ray emitting radionuclides (Fig. 2).

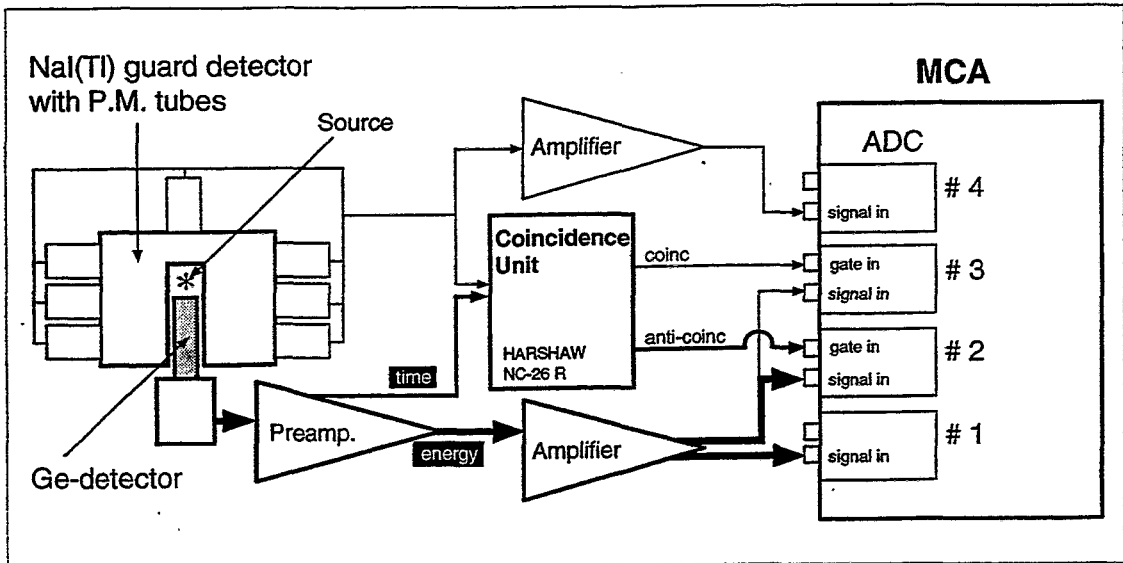

Fig. 2. The electronics block diagram for the simultaneous storage of the normal and the anticoincidence spectra using ADC#1 and ADC#2 respectively.

2 Performance

The normal and anticoincidence spectra of ^{137}Cs shown in fig. 3 provide information on the performance of the system. The peak to Compton edge is improved from 70:1 to 480:1.

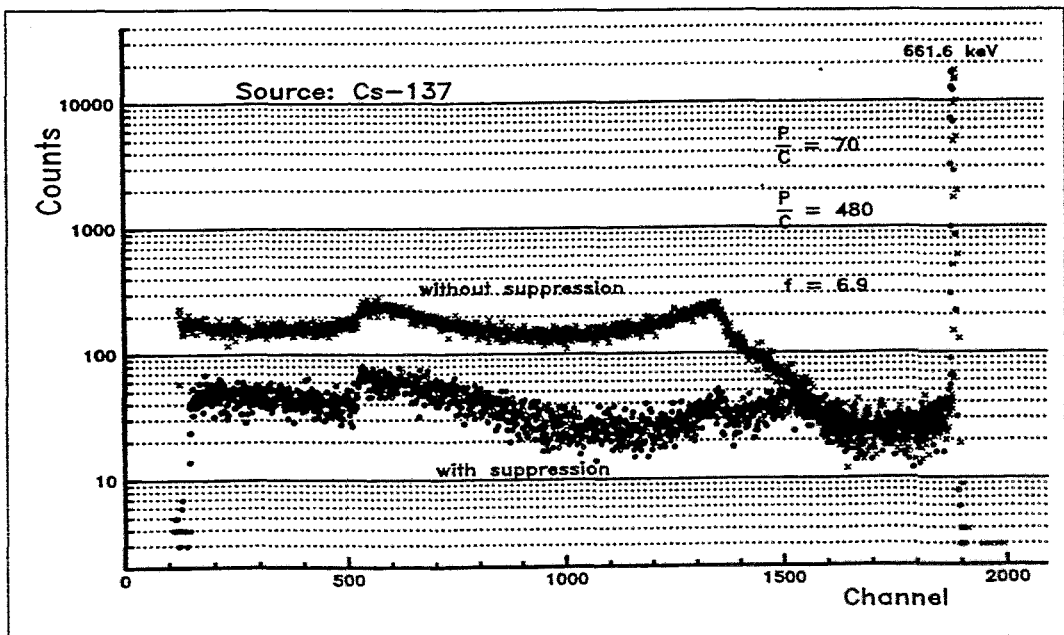

Fig. 3. Normal and anticoincidence spectra of ^{137}Cs

Fig. 4 shows three background spectra taken for 100 hours. The top spectrum is obtained with a Ge-detector (25% rel. efficiency) inside a lead shielding of 5 cm thickness. The middle and the lower spectra were obtained with the low-level system with and without using the anticoincidence suppression system.

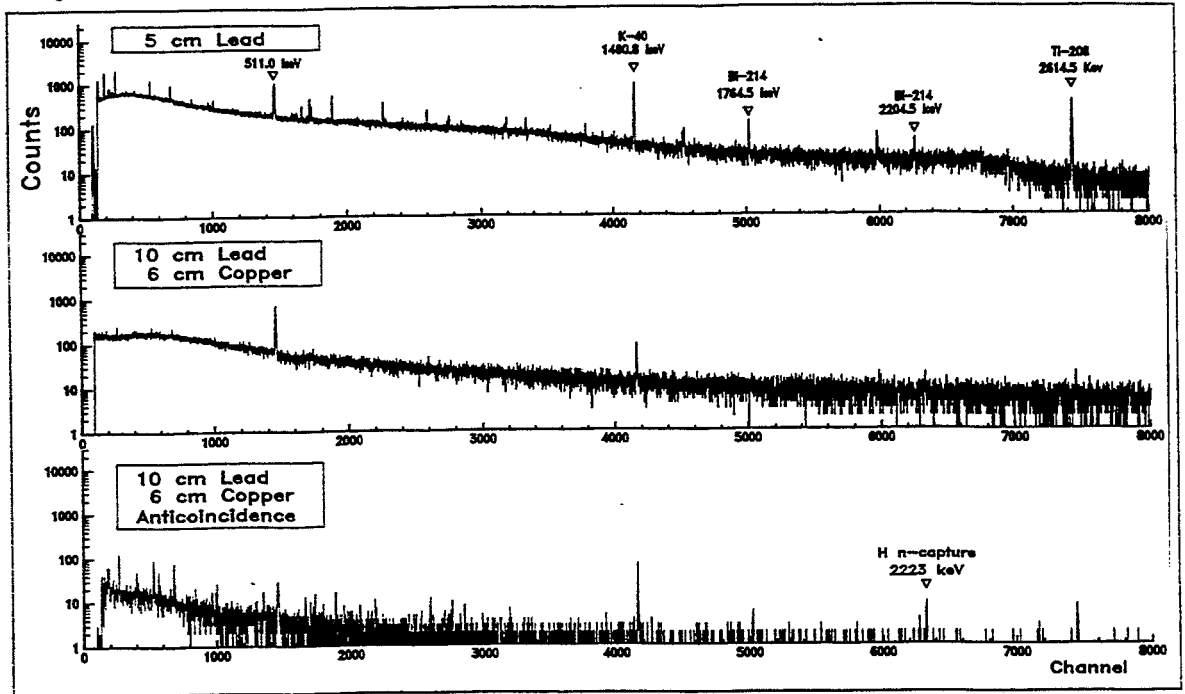

Fig. 4. Normal and anticoincidence spectra of the natural background.

Notice also that in the anticoincidence spectrum a peak at 2223 keV is visible. This is from the hydrogen neutron-capture interaction.

3 Application

Ceramic materials used in dentistry have been analysed in respect of their natural radioactivity, namely uranium, thorium and their decay products and the radioactive isotope potassium-40. For radiation protection reasons the content of radioactive isotopes is limited. E.g. in the draft international standard ISO 6872 it was stated: "Dental ceramic materials shall not contain more than 0.2 Bq/g ^{238}U ".

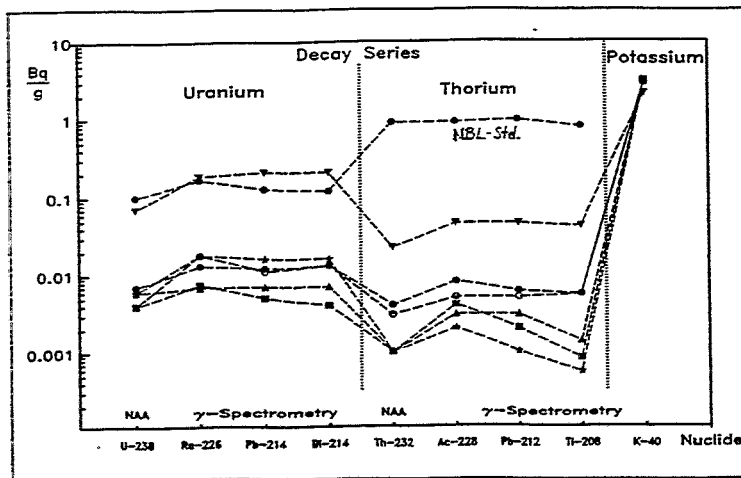

Fig. 5. Radionuclides in 6 samples of dental ceramics

Since precise figures are missing 20 samples from 5 manufacturers were analysed. Neutron activation analysis (NAA) was used for the determination of uranium and thorium. Some of the decay products of the U and Th series were determined by low-level gamma-ray spectrometry. Fig. 5 presents some typical results of 6 samples and a standard.

EXPERIENCES GAINED WITH AN ANTI-COMPTON SPECTROMETER WHEN UTILIZED FOR MEASUREMENTS OF NATURAL ACTIVITIES

Detlev Degering

TU Bergakademie Freiberg, Institut für Angewandte Physik

1. Introduction

Low-level γ -spectrometers situated on the surface often utilize anticoincidence systems like large area proportional counters for active shielding of background components. In this case the veto detectors are located *outside* the passive shielding. Another application of anticoincidence shielding is used in the so-called Anti-Compton spectrometers /1/. They are employed for the analysis of small activities in the presence of a larger one e.g. in neutron activation analysis. Its principle, the suppression of events which occur simultaneously in the measuring and a surrounding detector, is the same as for active background shielding but the veto detector is located *inside* the passive shielding. Since besides scattered γ -rays events due to interactions of cosmic radiation are reduced the question arises: does the use of this kind of γ -spectrometer make sense in low-level activity measurements?

Experiences gained within three years of operation of such an equipment are described in the following and their consequences for low-level spectrometers are discussed.

2. Instrumentation

The Anti-Compton spectrometer described here is located at the Institut für Nuclear Waste Management of the Forschungszentrum Karlsruhe and was built by EG&G ORTEC GmbH Munich Germany /2/. The surrounding NaI(Tl) detector consists of three units: an annulus 12" \varnothing x 12" around the analysing HPGe detector, a 3" \varnothing x 3" crystal placed in front of the HPGe detector for backscattered quanta and two half shells behind the HPGe detector endcap. Thus the active shielding covers sample cell and analysing detector in nearly 4π geometry. Two types of detectors can alternatively be used for measurements of the γ -spectra: a n-type coaxial HPGe-detector ("GMX", 56 % relative efficiency) or a semiplanar one ("LO-AX", 36 mm \varnothing x 16 mm). The NaI(Tl)-HPGe-detector system is housed in a 10 cm thick lead shield plus a graded inner layer of 4 mm copper and 4 mm plastic. Common fast-slow electronics was used to produce the pulse height distributions in anticoincidence ("AC") mode on or off.

Although originally not designed for the detection of low activities, the analysis of the effect of Anti-Compton suppression on different parts of ambient and sample background leads to valuable conclusions for measurements of low activities.

3. Results

The occurrence of primordial nuclides as well as interactions of components of the cosmic radiation in the surroundings of or in the detector itself leads to the background observed without any sample. Corresponding spectra collected with the GMX detector for 250,000 s under different conditions are presented in Fig.1. The *continuous background* arising from electrons, bremsstrahlung and scattered photons is reduced drastically by the lead shield and further passively by the NaI(Tl) detectors. Switching the AC mode on it is further suppressed by a factor of about 4 in the whole energy range. The remaining distribution has the shape of a β -spectrum up to 2 MeV.

Total count rates for different energy ranges of the spectra are listed in Tab.1 for AC mode on and off. The smaller suppression ratio in the low energy range is a result of γ -lines of U and Th daughters. These peaks, especially the occurrence of the 46 keV line of ^{210}Pb , and the remaining β -spectrum suggest the existence of impurities in the close vicinity of the HPGe detector e.g. in the aluminium housing of the NaI(Tl) detectors.

Corresponding count rate values for a comparable spectrometer with multiwire proportional counters on three surfaces of the lead shield /3/ are shown in Tab.2. The suppression ratios of about 3 are slightly lower than for the Karlsruhe spectrometer.

The influence of the sample *Compton background* on the appearing detection limits cannot be neglected even in the case of low activities. Being a result of γ -quanta scattered into or out of the HPGe detector its suppression is the original task of an Anti-Compton spectrometer. Thereby the decay scheme of a nuclide determines the efficiency of the background reduction. As an example for a single line nuclide, the spectra of ^{137}Cs are shown in Fig.2 for AC mode on and off. Their ratio reaches its maximum at the Compton edge with a value of ≈ 20 and falls down at the backscattering peak to ≈ 4 . Suppression can be observed down to the ADC threshold of 13 keV. The intensity of the full energy peak remains unchanged.

Fig.3 presents the results in the case of the two photon transition in the decay of ^{60}Co . Over a wide energy range the suppression factor is ≈ 30 and grows up to ≈ 60 at the Compton edges. On the other side the γ -peaks are reduced to one seventh since full energy absorption of one photon can coincide with an interaction of the second one in the active shielding.

The effect of the AC system is further enlarged when multi-photon transitions are investigated. This is illustrated by the spectra of ^{96}Tc which decays mainly via two triple cascades. The reduction of the continuum amounts to 40-60, that of the peaks to 20-30.

Considering a real sample containing mainly members of the U- and Th-decay series with an activity much above the blank, one gets for the reduction of the sample background a value of ≈ 10 (see Fig.5.) This means, similar samples of much lower activity exhibit a suppression between this and the limit of ≈ 4 as measured for the blank.

These examples show that the AC mode effectively diminishes the continuous part of the spectrum but acts in a strong way on the intensity of the peaks too. Therefore only the detection limits of single line nuclides are advantageously changed. For instance, ^7Be , ^{137}Cs , ^{210}Pb and ^{241}Am are of this type but not ^{125}Sb , ^{134}Cs and most of the U- and Th-daughters!

It should be mentioned, that under some circumstances the conditions for deconvolutions of multiplets are improved when applying AC mode on. This holds e.g. for the ^{234}Th double peak at 92 keV which interferes with the ThK_α X-ray peak. The latter occurs in Th bearing materials, is in coincidence with the exciting radiation and therefore in contrast to the photons from ^{234}Th reduced by the anticoincidence system.

4. Conclusions

An Anti-Compton system acts as an effective shielding against cosmic radiation and ambient background events. A comparison between such equipment in Karlsruhe and an externally shielded spectrometer in Freiberg showed a slightly better suppression ratio for the continuum with the big internal guard detector. But the large NaI(Tl) detectors do not only reduce the environmental radiation, they can also be a radiation source due to impure materials.

The influence of the AC system on the Compton background of the sample itself depends in a strong way on the decay schemes of all observed activities. Only nuclides with single photon transitions experience improvements of their detection limits! In some special cases the analysis of multiplets is simplified in the AC mode.

Therefore, the evaluation of the use of Anti-Compton systems for low activity measurements led to a balance between their advantageously high suppression efficiency and the limited number of nuclides with lowered detection limits.

References

- /1/ Landsberger, S., Peshev, S.; J. Radioanal. Nucl. Chem., Articles, 202 (1996) 201-224
- /2/ Wahl, W., et al.; Nucl. Instr. Meth. Phys. Res. Sect. A, 369 (1996) 627-633
- /3/ Preuße, W.; PhD thesis, TU Bergakademie Freiberg 1993

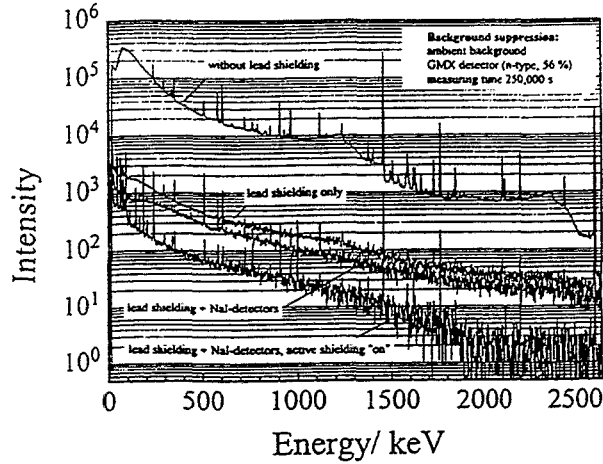

Fig.1. Spectra of the background radiation without a sample. Measured with the GMX detector (56 % ,n-type) for 250,000 s under different conditions

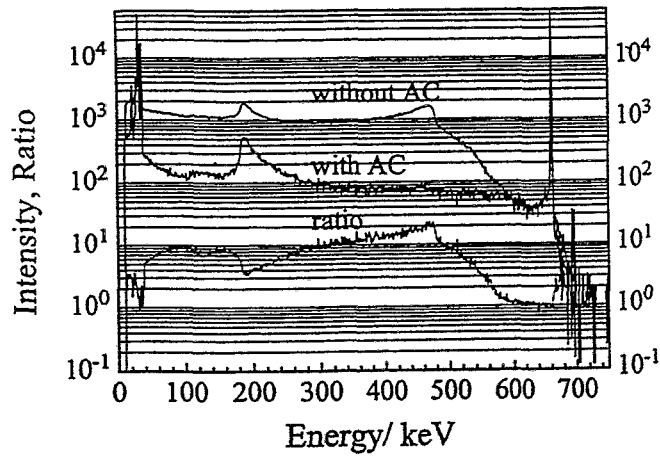

Fig.2. Spectra of a ^{137}Cs point source with anticoincidence (AC) mode on and off as well as the ratio of the two spectra. Measured with the LO-AX detector (semiplanar, n-type)

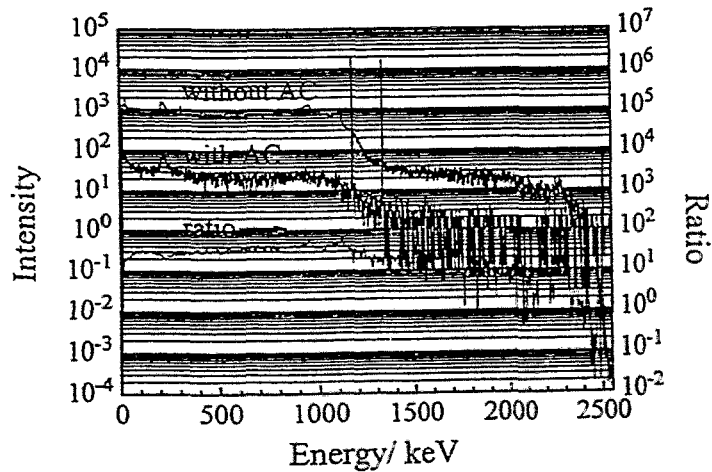

Fig.3. Spectra of a ^{60}Co point source with anticoincidence (AC) mode on and off as well as the ratio of the two spectra. Measured with the LO-AX detector (semiplanar, n-type)

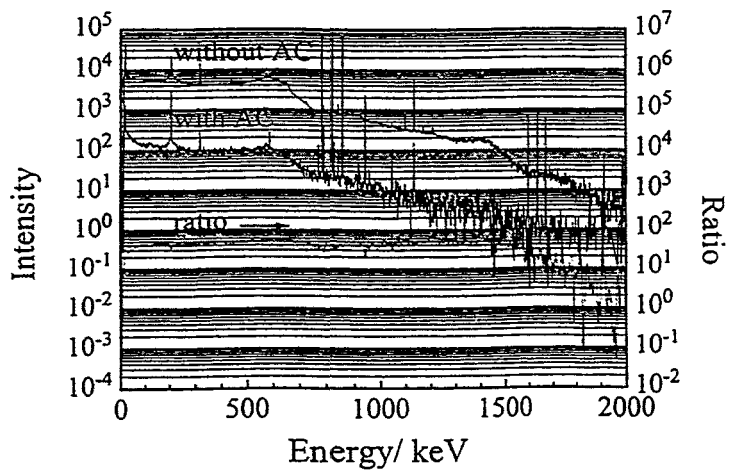

Fig.4. Spectra of a ^{96}Tc source with anticoincidence (AC) mode on and off as well as the ratio of the two spectra. Measured with the LO-AX detector (semiplanar, n-type)

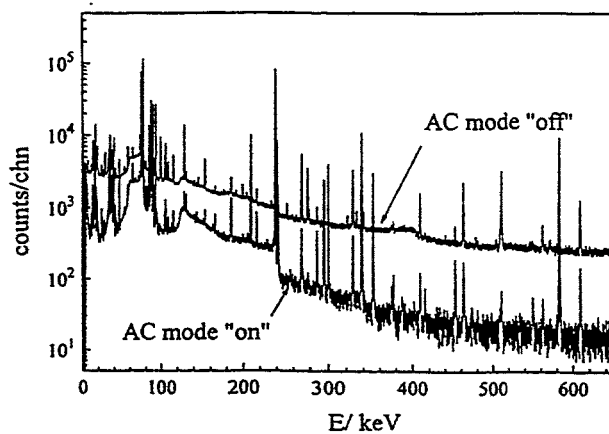

Fig.5. Spectra of a monazite sand sample from Steenkampskraal (South Africa). Measured with the LO-AX detector (semiplanar, n-type)

Energy range/ keV	LO-AX-detector (semiplanar, n-type)			GMX-detector (n-type, 56 %)		
	AC off	AC on	ratio on/off	AC off	AC on	ratio on/off
50-100	0,063	0,036	0,57	0,294	0,186	0,63
100-500	0,147	0,041	0,28	0,977	0,290	0,30
500-1000	0,041	0,012	0,29	0,407	0,102	0,25
1000-2000	0,023	0,005	0,22	0,230	0,054	0,23
2000-2700	0,007	0,0003	0,04	0,060	0,005	0,08
50-2700	0,281	0,094	0,34	1,968	0,637	0,32

Tab.1 Background count rates (in s^{-1}) for different detectors and Anti-Compton mode off and on at the Karlsruhe spectrometer

Energy range/ keV	36 % HPGe-detector (p-type)		
	total	anticoinc.	ratio antic./total
50-100	0,079	0,036	0,46
100-500	0,55	0,2	0,36
500-1000	0,2	0,089	0,45
1000-2000	0,12	0,05	0,42
2000-2700	0,035	0,012	0,34
50-2700	0,984	0,387	0,39

Tab.2 Count rates (in s^{-1}) for the total background and in anticoincidence with the veto detectors at the Freiberg spectrometer /3/

LOW-LEVEL MULTICOUNTER β/γ SYSTEMS WITH EXTERNAL GUARDS IN SURFACE AND SHALLOW UNDERGROUND LABORATORIES

Páll Theodórsson
Science Institute, University of Iceland
Dunhaga 3, 107 Reykjavík, Iceland

1. Introduction

When weak samples are measured it is important that they can be given ample counting time in order to obtain satisfactory accuracy and that the background count rate can be checked well. This calls for a high counting capacity, which multidetectors can bring us. I will discuss development possibilities of low-level β/γ multidetector systems with an external antic cosmic shield that will in many cases be operated in underground laboratories. These simple and low-cost systems can frequently help us in increasing the number of detectors. Three concepts are combined in these systems: (1) multidetectors, (2) an external antic cosmic (or guard) detector arrangement and (3) overburden shielding.

2. Multicounter systems

Electronic integrated circuits were introduced in the early 1960s. It was, however, not until a decade later when integrated circuits with the low-energy MOS transistors had been developed to the degree that hundreds of them could be put on a single chip and when the microprocessor had been invented that modern information technique was borne. Before this, the cost of the electronic part of low-level systems was substantial, even the main part of the total price of counting systems. This changed radically in the 1970s and designers of low-level counting systems were faced with new prerequisites. When the detector itself was not expensive, it now became economically feasible to work with a much larger number of detectors, combined into a single, compact system.

One of the earliest multidetector systems based on the new electronic technique, a compact Geiger-counter unit with 5 detector elements, was designed in 1973 at the research center of the Danish Atomic Energy Commission, now called Risø National Laboratory [1]. The simple electronic system used a mechanical printer.

A parallel development in radiocarbon dating started at the radiocarbon dating laboratory of the University of Heidelberg in the late 1970s when a system with 9 identical 4.0 liter sample detectors inside a common lead shield, sharing a common guard counter system, was constructed [2]. An important new feature of this system was the application of a PDP-11 minicomputer, then the state of the art in computers of medium size. It replaced most of the conventional electronic system as it collected and processed the signal from all the counting channels and the guard counter. Today, low-cost PC-computers are generally used for this purpose in similar systems. Late in the 1980s the multicounter technique was expanded to liquid scintillation counting.

3. Inner shielding layer and external guard counters

Libby introduced the antic cosmic (or anticoincidence) counting technique in order to reduce the dominant muonic background component. A few years later, an inner layer of mercury or lead

was added between the sample counter and the guard in order to absorb gamma radiation from contamination in the main shield and components inside it. It soon became clear that this arrangement also reduced the background component due to secondary gamma radiation induced by muons and protons in the shield. The highest background reduction could be obtained by having the whole mass of the passive shield inside the guard, that is, an external guard counting system. This was partially tested in a couple of gas proportional counting systems by placing a single, large, flat guard counter on the top of the shield. Although the results were positive, this technique was not developed further.

External guard counters were first introduced in routine use in ultralow-level germanium spectrometers late in the 1980s, for example at the Pacific Northwest laboratory in USA and at Max Planck Institut für Kernphysik in Heidelberg (by G. Heusser). These systems proved the high background reduction efficiency of this arrangement. For economic reasons, a single top guard counter, giving only a partial antic cosmic coverage, has in some cases been used. Now there are probably about 10 such low-level germanium spectrometers. External guard counters have not yet been used with other types of sample detectors.

4. Overburden background reduction

In carefully designed systems the background component due to secondary radiation dominates, also in shallow underground laboratories having an overburden mass m_{ob} of up to 20 meters water equivalent (mwe). Deep underground this component can be reduced practically to zero. A guard counter system externally covering all six sides of the shield will reduce the background of a germanium detector by a factor of about 6 (83% reduction) in a surface laboratory and a factor of about 12 (92% reduction) when the overburden is 15 mwe.

The residual background in well-designed systems is proportional to the flux of the cosmic muons. The value of the flux, compared to its value at zero overburden, is given by

$$A_{\mu}(m_{ob}) = 10^{-1.32 \log d - 0.26 (\log d)^2} \quad (2)$$

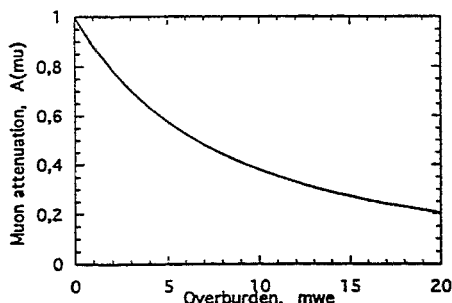

Figure 1. Attenuation factor of muons.

where $d = 1 + m_{ob}/10$ and the overburden m_{ob} is given in mwe. This empirical equation describes the attenuation of the muons to within 5% down to 100 mwe. This attenuation is shown in Figure 1. When it is taken into account that the external guard counter system is about doubly as effective in background reduction at 20 mwe overburden than at zero overburden, we can expect a background reduction of a factor of 10 at this depth, compared to a surface laboratory.

The advantage of lower background in an underground laboratory must be weighed against the disadvantage of taking the samples to a remote counting room. The extra work depends both on the distance and the frequency of sample changing. In most cases the counting time will be a few days, it may even be weeks. With modern technique it is simple to read the the data stored in the system computer through a telephone line. One will therefore only need to come for changing samples.

5. Proposed multiscounter systems

Examples of multiscounter systems will be given below with a brief description. Ge-detectors are too expensive to warrant a multiscounter system. In systems where the detecting medium is either liquid or solid, the pulses from direct hitting muons are large, well above our region of interest. We can therefore tolerate that some of the muons hitting the detector are not detected by the guard detector. We therefore need less geometrical coverage of the sample detector by the guard counter system. This can considerably simplify the guard counter system. A 5-cm-thick layer of lead between the guard counter and the sample detector below will attenuate the secondary radiation formed in the lead above the guard counter by a factor of 10. A single flat guard detector is an acceptable compromise between efficiency and simplicity. In order to maximize background reduction it is probably best to sandwich the guard detector with 5 cm of lead below the guard and 5 cm above it as shown in Figure 2B and 2C. This arrangement can be called a semi-external guard counter system.

Window flow-detectors for solid β -samples. Multiscounters of this type are easy to make and it is a simple matter to construct a unit with 10 to 20 detectors. A typical detector of this type with a window diameter of 25 mm has a background of 0.20 cpm in a surface laboratory. We can expect a background of about 0.01 cpm in a system with an external guard counter system operating under an overburden of 20 mwe.

Internal gas proportional counters, for example for radiocarbon dating, can be improved considerably by replacing the inner guard detector with an external guard counting system. Most of the present systems have a 2–4 cm thick inner shield of lead or mercury, which significantly reduces the background component due to secondary radiation.

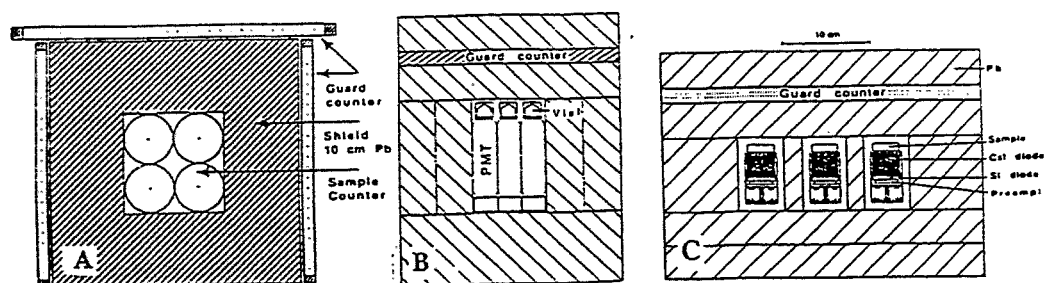

Figure 2. Multidetector systems with antic cosmic shielding: with internal sample gas proportional counters (A), with single PMT liquid scintillation detectors (B) and with Csl gamma detecting crystal where a Si phototube detects the scintillations.

External guard counters will, in addition to reducing the background still further, drastically decrease the mass of the shield, by a factor of about 5, as the guard is removed from the inside of the shield and the conventional 10-15 cm thick layer of boronated paraffin is superfluous. A good counter with a volume of 1.0 liter and working at 3 atm pressure of CO_2 at $M_{\text{Ob}}=0$ has a background of about 1.5 cpm. In a system with an external guard (Figure 2A) we can expect a

background of 0.8 cpm in a surface laboratory and 0.20-0.25 cpm at $M_{ob} = 20$ mwe. The total weight of the shield with 9 detectors will be about 1500 kg.

Liquid scintillation counting (LSC) systems. A basically simple multiscouter system with LSC detectors has been described [3]. It uses a single photomultiplier tube (PMT) for light detection and the sample vial is surrounded by a large NaI well guard crystal unit. The background is about 0.35 cpm in a 70% efficiency ^{14}C window. The system proposed here (Figure 2B) has a single semi-external guard counter. In a surface laboratory the background in the ^{14}C window will probably be about 0.5 cpm and about 0.3 cpm in a laboratory with an overburden of 20 mwe. With PMTs made of glass where the radiocontamination has been reduced by a factor of 10 compared to present day glass, I would expect a background count rate of about 0.1 cpm. Because of the simplicity of the sample detector units and the electronics needed, it would be a relatively simple matter to have a system with 9–16 sample channels. Such a system would only weigh about 1000 kg.

NaI and CsI γ -detectors. Ge-spectrometers, with their high energy resolution and low background, largely replaced NaI scintillation detectors in the early 1970s in low-level work. The NaI detectors still have the advantage of lower price, larger detectors and higher intrinsic detection efficiency. The radioactive contamination, which is always present in the glass and ceramic supports of the PMTs, limits seriously the possible background reduction. New phototubes, made of glass where the contamination has been reduced by a factor of 10–20, may partly rehabilitate the NaI units. Multidetector NaI systems with external guard counters in underground laboratories may become an attractive possibility in near future in some low-level gamma work.

Today, very compact CsI gamma scintillation detector units are being produced where large silicone light detection diodes, rather than a conventional PMT, sense the scintillations. These units are completely free of radiocontamination, but electric noise in the diode limits their use to high-energy gamma radiation, above about 300 keV. Figure 2C shows a proposed multiscouter system with a guard counter and 9 such sample detector units.

References

- [1] Pall Theodorsson: Measurement of Weak Radioactivity, (Section 15.7), World Scientific, Singapore, in press.
- [2] H. Schoch, M. Burns, K. O. Münnich and M. Münnich: A multiscouter system for high precision carbon-14 measurements, Radiocarbon 22, 442–447, 1980.
- [3] S. A. Einarsson: Evaluation of a prototype low-level liquid scintillation multisample counter, Radiocarbon 34, 366–373, 1992.

IV. Environmental Behaviour of Radionuclides and Low-Level Measuring Techniques for Exposure Assessment

Chairperson: W. Görner

MEASUREMENT OF RADIOACTIVE NUCLIDES IN THE "MAYAK" REGION

B.F. Myasoedov and A.P. Novikov

V.I. Vernadsky Institute of Geochemistry and Analytical Chemistry, Russian Academy of Sciences, Kosygin str.19, Moscow, Russia

1. Introduction

The study of environmental contamination caused by anthropogenic impact and, primarily, by radioactive nuclides is one of the main scientific problems facing contemporary science. Radioecological monitoring, decision making on remediation of polluted areas need detailed information about distribution of radioactive nuclides in the terrestrial and aquatic ecosystems, knowledge about radioactive nuclide occurrence forms and migration patterns.

Experimental tests of nuclear and thermonuclear weapon in atmosphere and underground, nuclear power engineering and numerous accidents that took place at the nuclear power plants (NPP), unauthorized dump of radioactive materials in various places of the ocean and pouring off the strongly dump of radioactive wastes from ships and submarines equipped with nuclear power engines made artificial radionuclides a constant and unretrievable component of the modern biosphere, becoming an additional unfavorable ecological factor. As regards Former Soviet Union (FSU) the most unfavorable regions are Southern Ural, zones suffered from Chernobyl Accident, Altay, Novaya Zemlya, some parts of West Siberia near Seversk (Tomsk-7) and Zheleznogorsk (Krasnoyarsk-26).

2. Modern situation at regions of Russia contaminated by radioactive fallout

Chernobyl accident. In April of 1986, the N4 reactor at Chernobyl exploded releasing 100 million Curies of radioactive material into the environment. As many as 235.000 people were evacuated, 70 villages abandoned, and 600.000 people exposed to excess radiation. Today the site is surrounded by a 30 kilometers evacuated zone and a 10 kilometers severe restriction zone. The radiation levels are 200-500 roentgens inside the containment vessel, 4 roentgens on the roof, 500 microrems per hour in a parking lot 200 meters away, and 60 microrems per hour in the city of Chernobyl, 14 kilometers away. Because of the high radiation and heat levels inside the containment vessel, material degradation has been more severe and rapid than expected and numerous cracks have had to be repaired. Designs for a more permanent solution are now being considered.

"Chernobyl" radionuclides are distributed in many regions of Russia. Total area of regions with Cs-137 content more than 1 Ci/km² is 57.650 km², with population about 2,7 millions. Nowadays radiation doses at these areas are due to only Cs-137 and Sr-90 (contamination of soil by Sr-90 is 1-5 % relative to Cs-137). The actinides were dispersed in form of small fuel particles deposited in surrounding area (30-km zone). At present plutonium contamination level on some parts of the zone reaches the figure as high as 0.05 Ci/km². Actually all the alpha-contamination is mostly represented by the following transuranium radionuclides: neptunium-237, plutonium-238, 239, 240, americium-241 and curium-242, 244. Relative contribution of these radionuclides into gross alpha-contamination changes with time. At the first days after the

accident more than 80 % of alpha-contamination belonged to Cm-242. Now, when passed about 10 years near 60 % of alpha-activity belongs to the sum of plutonium isotopes, more than 35 % - to Am-241 and the rest of the activity belongs to Cm-244 and Np-237.

Altay. Population of Altay is excited due to many nuclear explosions at the Semipalatinsk test field. But nowadays average contamination level of Altay is 0.1 - 0.2 Ci/km² Cs-137, 10 - 50 mCi/km² Sr-90 and 5-20 mCi/km² Pu-239. Only two relatively small areas with content 0.2 - 0.5 Ci/km² were determined. Main part of this radiation (80 %) is due to the first nuclear explosion in 1949.

Southern Ural. Radioactive contamination of some areas of Southern Ural is due to enterprise "Mayak" that was founded more than 45 years ago for production of the weapon plutonium and reprocessing of fission materials. The activity of "Mayak" has resulted in local accumulation of large quantities of wastes from radiochemical technology, and radioactive contamination of parts of the territory of Chelyabinsk, Kurgan and Sverdlovsk regions by long - lived radionuclides, mainly ⁹⁰Sr, ¹³⁷Cs and ²³⁹Pu. Radioactive contamination of the Ural region are partly due to liquid radwaste discharge into the small Techa River which belongs to the hydrographical basin of the Ob' River, accidental discharge into the atmosphere resulting from the detonation of a radwaste tank on 29th September 1957, and radioactive substance resuspension from dried - up shores of Lake Karachay in the dry spring of 1967.

About 76 million m³ of wastes containing 2,75 million Ci of radionuclides were discharged directly into the Techa River in 1949 - 1956. About 95 % of this amount of radionuclides (about 4300 Curies / day) was discharged from March 1950 to November 1951, and was deposited within the first 35 kilometers downstream. The most part of these radionuclides has been accumulated in the upper reaches of the river, however, the Iset', Tobol, and Ob' Rivers, which successively drain into each other, were also contaminated. The average concentrations of ⁹⁰Sr, ¹³⁷Cs, ²³⁹Pu in the bottom sediments of Techa River on 1993 year at the Muslimovo Settlement 78 km downstream was 2.2, 0.3 and 0.025 pCi/kg respectively. The concentration of radionuclides in the Iset was about a factor of 10 lower than in the Techa, and about 100 to 1000 times lower than in the Tobol.

The majority of radioactive wastes is located in 257 ground surface storage tanks (10⁹ Ci), in water reservoirs (0.5 * 10⁹ Ci), in Karachai lake (1.8 * 10⁸ Ci).

Western Siberia. In the West Siberian Basin is located a significant fraction of FSU nuclear program that has operated for the last 50 years; it includes many nuclear facilities, among which are two spent nuclear fuel reprocessing sites - Tomsk-7 and Krasnoyarsk-26. These are believed to be responsible for the majority of the radioactive contamination that is to be found in the major river systems that feed into the Arctic Ocean through the Kara Sea.

The Krasnoyarsk plutonium production plant comprising the reactor, radiochemical and some auxiliary facilities is under operation for more than 35 years. Two industrial reactors were shut down in 1992. The third reactor which is used both for Pu production and for electricity and heat production is currently under operation. Industrial straight flow type reactors use the Yenisey river water as a coolant after its special pretreatment.

Neutron radiation field from reactor produces radiation-induced radionuclides in the cooling water such as Mn-56, Na-24, Np-239, As-76, Si-31, P-32 and Cu-64, etc., which are discharged into Yenisey river through the special waste water pipelines. In addition to radiation induced

nuclides there is some inflow (though in much lesser amount) of fission products (I-131, Ru-166, Sr-90, Eu-152, Sb-124, and Pu-238, 239). They may enter the environment as result of gas-aerosol discharges or secondary wash out from the water collecting areas, or with waste waters not classified as radioactive wastes. In 1991 year maximum contamination level of flood-lands of Yenisey river was 0.02 - 0.05 Ci/km² for Pu-238-240.

Arctic Area. In Arctic area of Russia a number of nuclear weapon tests were conducted since 1965. Among them three tests were carried out in Kol'skiy peninsula (near Kirovsk town); twelve tests - in Yakutiya (near Udachniy town); twelve - in the northern part of Arkhangel'sk region and in Western Siberia (including Tyumen' region - near Surgut, Beloyarsk, Nyagan' and in other places); in Krasnoyarsk area - near Igarka town (two tests), and at Bol'shaya Kheta river. Some nuclear tests in neighbor areas (Perm' region, Northern Ural) contributed also to radioactive pollution in Arctic part of Russia. Dose rate from gamma emitting nuclides does not exceed 2-3 microRentgen per hour, this corresponds to 5.5 - 6.5 microR/h taking into account a cosmic ray constituent. Contribution from some technogenic radionuclides (Cs-137 and others) amounts to 10-15 %, in some cases up to 30 % of overall dose rate. Surface contamination density of soils by Cs-137 was found to be about 0.06 Ci/km², which is twice lower as compared with the middle latitude areas.

Potential danger of radioactive contamination of Arctic area is coming from some military facilities located there and, first of all, Northern Fleet of Russia and the Central Testing Ground for Nuclear Weapons at Novaya Zemlya island. About 6-7 thousand cubicmeters of liquid radioactive wastes are generated annually as result of Northern Fleet operation: among them 30 % refer to White Sea area and 70 % - to Barents Sea region. Annual amount of solid radioactive wastes is estimated to be about 4,5 thousand cubic meters. The FSU has also disposed of nuclear waste in the Kara Sea: at least 16 nuclear reactors (6 with fuel), over 10.000 containers of low - level radioactive waste, and liquid waste, from which the total potential nuclear contamination is 86.2 PBq.

3. Methods and data on radiomonitoring of "Mayak" zone

The systematic investigation by our Institute of the content and occurrence forms of radionuclides of strontium, cesium, cerium, plutonium and transplutonium elements (TPE) in soils of different natural zones, contaminated from a variety of sources - global fallout, NPP activities, after the Southern Ural's and Chernobyl accidents have been permitted to develop the methodology of a complex ecological and geochemical studies of artificial radionuclides. The sampling modes and procedures, methods of radionuclide's field preconcentration, effective leaching in solution from solid samples, selective isolation to individual detection and techniques of speciation of radionuclides in solutions and solids have been elaborated and approbated [1-4].

The sampling modes and procedures vary due to both radionuclides properties and environmental local peculiarities. Radionuclides behavior in biosphere in general depends upon their original occurrence forms and the environmental conditions they meet with (ecosystem type, its structure and anthropogenic distortions). All these factors and the objectives of a particular study define the sampling procedure [5].

When observing low content of determined elements in natural waters it's practical to perform a ad-hoc preconcentration procedures directly at the sampling point. With this aim technique of selective preconcentration of plutonium by membrane filtration with water-soluble polymer has

been elaborated [6]. In this procedure analyzed water moves under pressure (300 kPa) consecutively through two cells equipped with membrane filters. An average pore size of the first membrane equals to 0.5 μm , and the second is approximately 1.5 μm that corresponds to a 10.000 nominal molecular weight limits. The solution in the second cell is kept constant in volume during filtration and contains a water soluble polymer - poly (ethyleneimine) - diethylenetriaminepentaacetate (PEI-DTPA). The main feature of the method under discussion consists in displacement of an equilibrium between plutonium species during interaction with a strong complex forming reagent as DTPA. All chemical reactions in that case are homogeneous so their general rate considerably exceeds the rate of similar sorption process including diffusion steps.

For selective isolation of radionuclides ^{90}Sr , Np , Pu and transplutonium elements (Am , Cm) from soil leachate we use a chromatographic technique. The method is to gradually isolate radionuclides from a leaching solution when a peristaltic pump carries it through three columns filled with selective sorbents followed by membrane-extraction cell.

In order to isolate plutonium we use columns of inner diameter of 10 mm and 160 mm high which are filled with a low acidic VP-1AP anionite (4g air-dry reagent). Upon isolating plutonium the obtained solution is diluted with water up to 1 M HNO_3 and is then processed on the column of 10 mm diameter. The thickness of the sorbent layer (polyarsenazo-n) is 7 mm (sorbent weight is 200 mg).

Having isolated plutonium and transplutonium elements we isolate ^{90}Sr from the leaching solution with the extraction chromatographic method using a porous polymer matrix (TVEX) impregnated with 5 % solution of dicyclohexyl-18-crown-6 in tetrachloroethane; high of column - 100 mm, diameter - 10 mm.

One of the most difficult problems is to isolate and identify neptunium in environment because of the low specific radioactivity of this radionuclide. However, according to our data it is one of the main radiomigrants in some regions of Russia especially in Chelyabinsk.

To identify the neptunium in environment reliably we have developed an original method. Having isolated Pu , Am , and Sr we add into the analyzed solution up to 0.5 M sulfuric acid, hydrazine and up to 10⁻⁴ M of potassium phosphotungstate (K10P2W17061). Then we heat it in a boiling water bath for 30 min. After cooling we put into the solution a porous teflon membrane (pore diameter 0.5 μm , area 1 cm^2) impregnated with 0.5 M trioctylmethylammonium nitrate (TOMAN) solution in toluene and shake it for two hours. Then we place the membrane in quartzite crucible containing 200-20 mg of lead molybdate and calcine it for an hour at 900°C. Finally we determine the content of neptunium by its luminescent spectra [7].

The data on distribution of radionuclides - ^{90}Sr , ^{137}Cs , ^{237}Np , ^{239}Pu and ^{241}Am between components of various ecosystems of Southern Ural region as well as their forms of occurrence have been obtained. The fractionation of radionuclides upon size and charge of colloidal particles, group of organic substances and mobile forms has been studied. The data obtained show that ^{90}Sr , ^{237}Np and ^{241}Am mostly involved in compounds of fulvic acids that's why they have a high mobility in the environment. On the contrary, considerable amounts of ^{137}Cs and plutonium have been found in low soluble humic acids bonded primarily with calcium and relatively low mobile hydroxides.

The data on vertical migration of plutonium in various types of soils has been obtained and corresponded coefficients has been calculated. On the basis of these data the prediction of changing the plutonium concentration profiles in a typical leached chernozem under forest at the Mayak zones has been done.

We consider that one of the most important factors affecting migration resistance of soil media is the content and nature of organic substances. In particular, the clear dependence between diffusional resistance of upper soil layers to plutonium and radiostrontium mass-transfer and content of humus in these layers has been determined. The correlation between migration coefficients and the content of the most mobile plutonium forms has been revealed.

References

- [1] B.F. Myasoedov, New method of transplutonium element separation and determination, *Journal of Alloys and Compounds*, 213/214, 290-299 (1994).
- [2] N.Yu.Kremlyakova, A.P.Novikov, S.G.Korpusov, B.F.Myasoedov, Method of determination of plutonium and radiostrontium in environmental samples, Patent Rus., 4924649/25 (1991).
- [3] A.P.Novikov, M.N.Mikheeva, T.I.Trofimoff, Yu.M.Kulyako, Method of americium isolation and determination, Patent Rus., 4897664/23 (1990).
- [4] A.P.Novikov, S.A.Ivanova, M.N.Mikheeva, B.F.Myasoedov, Method of determination of neptunium in environmental samples, Patent Rus., 5146273/27 (1992).
- [5] B.F.Myasoedov, A.P.Novikov, F.I.Pavlotskaya, "Measurements of Radioactive Nuclides in the Environment: problems of determination and speciation", *Zhurn.Anal.Khim.*, 51, 1, 124-130 (1996).
- [6] A.P.Novikov, V.M.Shkinev et al, "Separation and Preconcentration of Actinides by Water-Soluble Oxine Polymer Using Membrane Filtration", *Radiochemica Acta*, 1989, v.45, pp.35-37.

Radiochemical Separation of Actinides for their Determination in Environmental Samples and Waste Products

B. Gleisberg

*Nuclear Engineering and Analytics Rossendorf Inc. (VKTA)
P.O. Box 510119, D 01314 Dresden*

1. Introduction

The analysis of samples of extremely different origin and activity levels requires a variety of instrumental and radiochemical methods.

When interfering influences result from the sample itself, the chemical separation is the only one suitable treatment to prepare the sample before the measurement.

The determination of low level activities of actinides in environmental samples and waste products makes high demands on radiochemical separation methods (remove the sample components completely and isolate interfering nuclides from those to be determined).

The factors influencing the algorithm of the analysis are such as the sample matrix, all nuclides to be determined (actinides and other), level of activity and ratios of nuclides, the availability of sample material, the requested accuracy and detection limit, the available methods of measurement and economical aspects.

2. Examples of application

Artificial and natural actinides were analyzed in the last years in a variety of samples. Typical examples are:

- samples from the surrounding areas of NPP and of uranium mines (soil, sludge, sediments, water, air filters, plants)
- incorporation samples (urine, faeces)
- solutions containing radioactive fuel
- solutions and solids resulting from the process
- wastes

3. Radiochemical separations

3.1. Artificial actinides

A radiochemical separation scheme of artificial actinides and Sr in samples, where the sample material is limited and low detection limits are demanded (e.g. incorporation samples, air filters), is presented in fig.1. In this case all requested nuclides (e.g. Sr-90, U-234/235/238, Pu-238/239/240, 3-valent actinides) must be separated and analysed in one single separation process.

After adding radiotracers and carriers the sample is decomposed. The obtained solution is aliquoted. 5% of the sample is used for the determination of uranium isotopes by ICP-MS. The results are compared with those of α -spectrometry and used for quality assurance. The main part of the sample solution is used for radiochemical analysis. After precipitation and dissolution U- and Pu-isotopes are extracted by TOPO and reextracted simultaneously. In dependence of the matrix and the nuclide ratios U and Pu can be electroplated together or an additional separation of U from Pu and other impurities is necessary. The separation by anion exchange is presented in fig. 2. Because Sr remains in different fractions, they all must be collected and combined for Sr-90-analysis.

Fig. 1
Chemical isolation for the analysis of
U- and Pu- nuclides and Sr-90 in a single sample

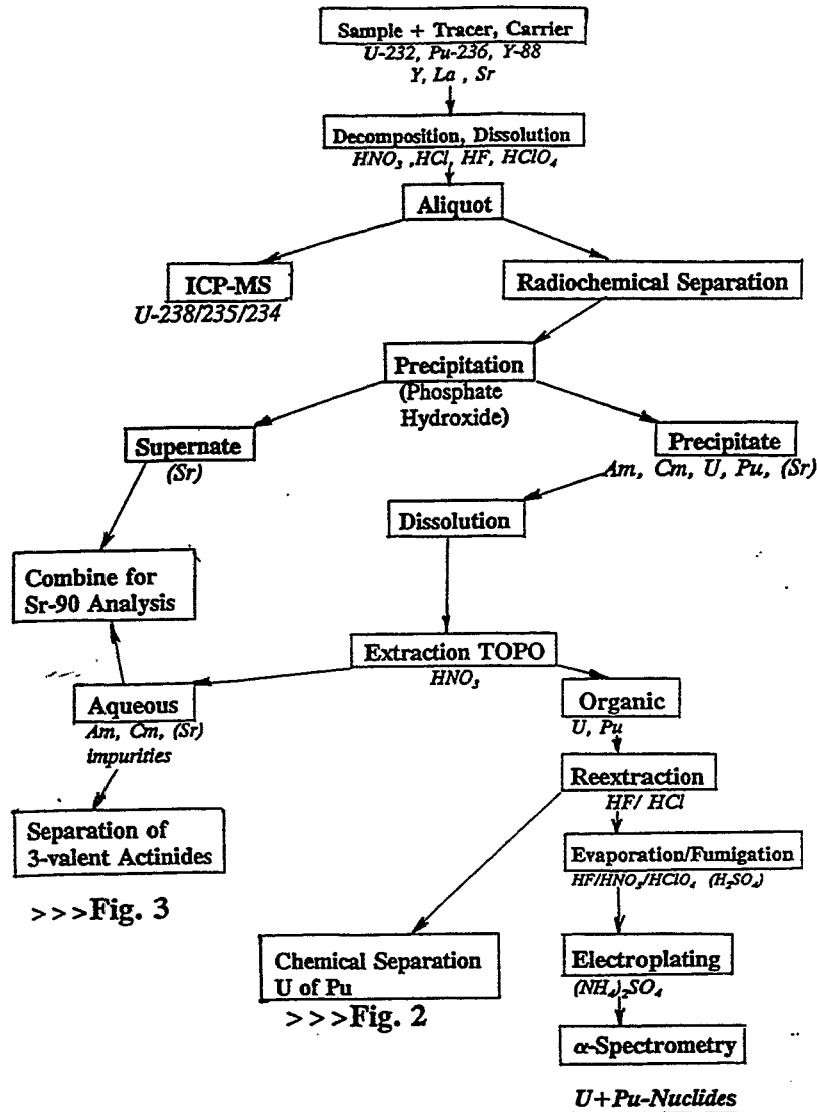

The separation of 3-valent actinides by cation exchange is shown in fig. 3. 3-valent actinides are eluted together with lanthanides by 6 M nitric acid. Before electroplating 5% of the solution is taken for determination of the chemical yield η by ICP-MS. This determination of the chemical yield by adding of La m_a is applicable if no radiotracer is available. 3 ICP-measurements are necessary:

1. after decomposition m_0 (fig. 1), La-content of the sample $(m_0 = m_a + m_s)$
2. before electroplating m_1 (fig. 3)
3. after electroplating m_2 (fig. 3)

The chemical yield is calculated by:

$$\eta = \frac{m_1 - m_2}{m_0}$$

If the original solution contains great amounts of lanthanides no thin layers are electroplated. In those cases the α -spectrometric determination of 3-valent actinides can fail.

If the material of samples exists in adequate quantities, different separation procedures can be used.

Fig. 2
Chemical separation of U and Pu

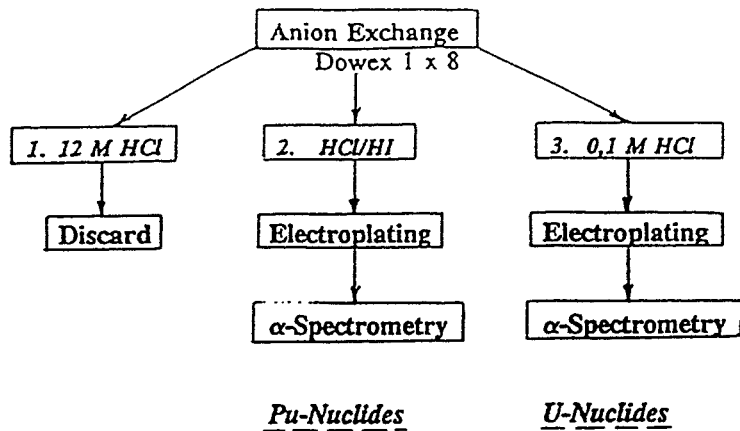
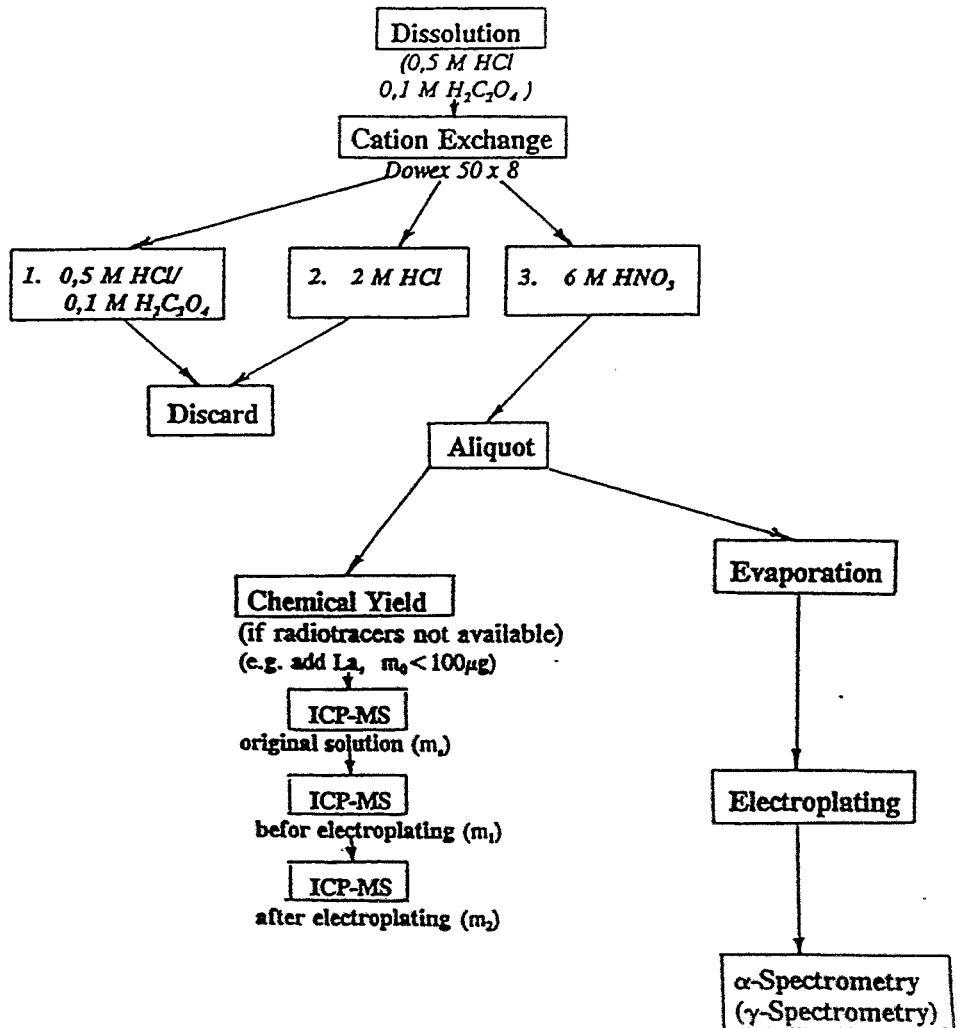

Fig. 3
Chemical separation of 3-valent actinides after their isolation of U and Pu



3.2. Natural actinides

Samples for analysis of natural actinides are characterized by a wide activity range (for water samples: 0,005- 8000 Bq/l for individual nuclides).

The nuclide ratios differ from radiochemical equilibrium to extreme enrichment or reduced concentration of certain nuclides. The decay and reproduction of individual radioisotopes during the chemical separation and the time between separation and the measurement have to be taken into account.

Fig. 4
Radiochemical separation of natural actinides

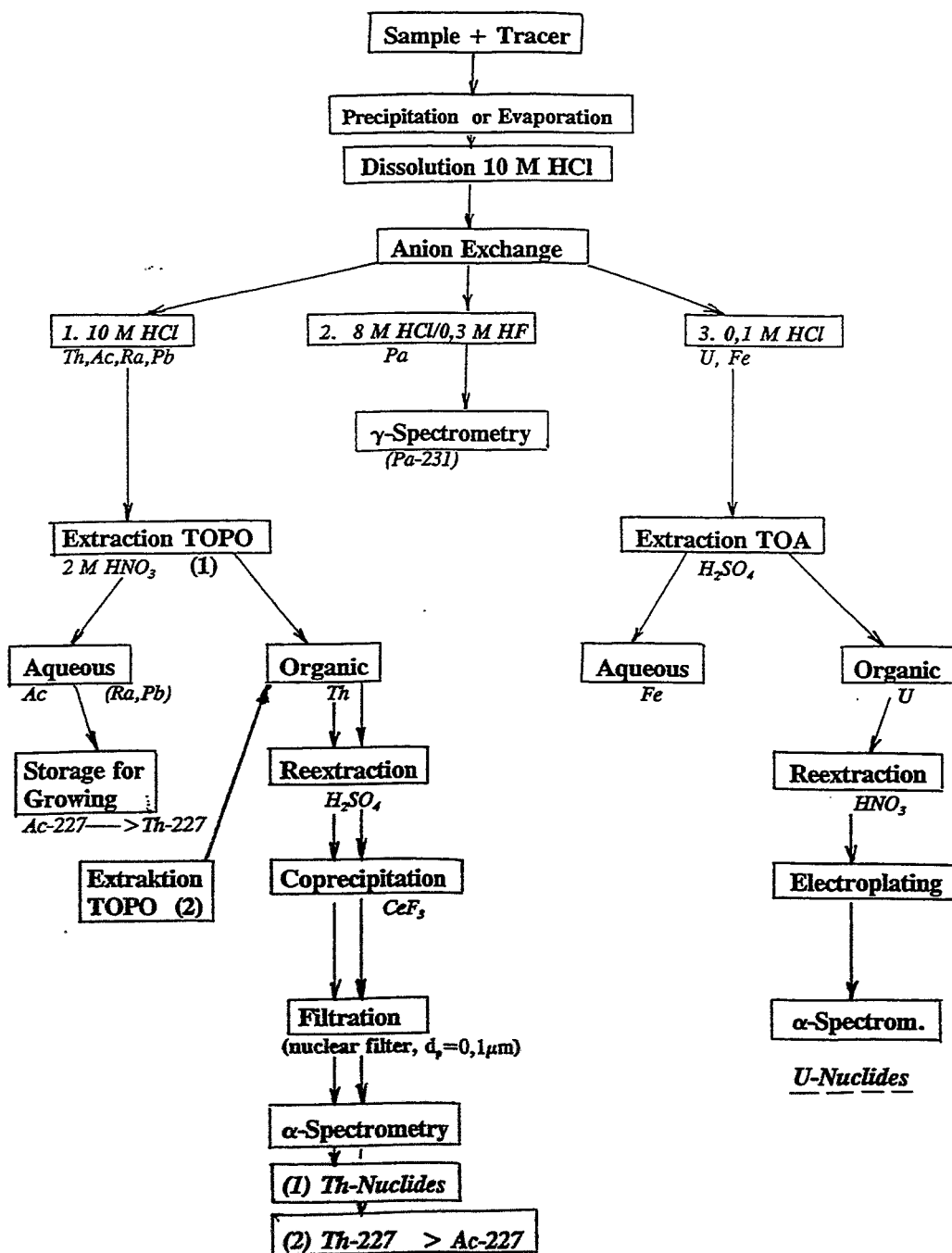

The radiochemical separation scheme for the determination of U- and Th-nuclides and Ac-227 is presented in fig. 4.

By anion exchange are separated Th, Ac, Ra, Pb from Pa and U, Fe.

The purification of the U-fraction (right column) is realized by extraction with trioctylamine, reextraction and electroplating. The chemical yield is controlled by U-232.

Th is separated from Ac and other matrix components by extraction with TOPO (left column).

Ac remains in the aqueous phase. The Th-nuclides are reextracted and coprecipitated with CeF₃.

The α -source is prepared by filtration on a nuclear filter with pore diameter of 0,1 μ m.

The Ac-227-containing fraction is stored up for growing of Th-227 from its mother.

Then the extraction (2) and all other steps are repeated. The resulting α -source of Th-227 is measured and the activity concentration of Ac-227 is calculated.

4. Results

4.1. The Results of intercomparison of faeces samples

The results of intercomparison of Pu- and U-nuclides in faeces demonstrate the accuracy of the methods.

Tab.1 Intercomparison of α -spectrometric analyses of Pu-239/240 and U-238/234 in faeces (Procorad, Cogema La Hague 1996)

Sample	Nuclide	ref. value [mBq/sample]	mean value [mBq/sample]	our results [mBq/sample]
A	Pu-239/240	16,3	15,1 \pm 3,4	18 \pm 2,7
B	Pu-239/240	10,9	10,2 \pm 2,6	10,0 \pm 2
C	Pu-239/240	not added	-	<1
A, B, C	Pu-238	not added	-	<1
A, B, C	U-238	not added	34,5 \pm 10	34 \pm 1
A, B, C	U-234	not added	45,5 \pm 10	39 \pm 1

Our results of Pu-239/40 are very close to the reference values. The mean values and our results of U-nuclides are in good accordance.

4.2. Low-level-wastes

One example of low level measurements of actinides and lanthanides after chemical separation is their determination in samples of evaporated residues from power reactors.

This low-level wastes contain about 20 MBq/kg Co-60 and Cs-137.

Such samples were usually characterized by the activity ratios of long lived actinides and lanthanides to the activity of a key nuclide.

These ratios are called scaling factors SF (Tab. 2).

Tab. 2 Specific activities in Bq/kg measured by α -and γ -spectrometry using an underground laboratory after radiochemical isolation

α	Pu-238	Pu-239	Am-241	Am-243	Cm-244	Cm-242
A.M	0.046	0.011	0.0314	0.041	0.092	0.91
SD	0.007	0.002	0.0015	0.023	0.01	0.25
SF	2.0E-6	4.8E-7	1.4E-6	1.8E-6	4.8E-5	5.2E-5
α	Pu-238	Pu-239	Am-241	Am-243	Cm-244	Cm-242
A.M	46	11	31.4	41	92	910
SD	7	2	1.5	23	10	250
SF	2.0E-6	4.8E-7	1.4E-6	1.8E-6	4.8E-5	5.2E-5
γ	Ce-144	Eu-152	Am-241	Am-243	Eu-154	Eu-155
A.M	1420	102	29.7	30	125	124
SD	140	20	1.0	15	7	7
SF	6.2E-5	4.4E-6	1.3E-6	1.3E-6	5.4E-6	5.4E-6

The measurement of scaling factors in low level wastes were carried out using our underground laboratory. In this way we are able to measure extremely low activities in the isolated fractions by γ -spectrometry. Therefore we need only low sample masses and low activities. This qualifies us to carry out the chemical procedures in a laboratory where it is allowed to handle with activities of the ten fold free-level.

Thus the reliable concept of using scaling factors for surveillance of power station wastes was improved by the application of low-level measuring techniques in our underground laboratory. Tab.2 demonstrates the accordance between the two spectrometric methods.

5. Conclusions

Looking to the separation schemes for determination of actinides it is demonstrated that there is a long way from the first sample treatment to an alpha-source of good quality and to a right result. These analyses require from the analyst a lot of experience in all details and to work very accurate.

Without any chemical separations the possibilities to measure low-level activities of actinides are limited. On the other hand without excellent measuring conditions the efforts of the radiochemical separation procedures will not get a reward.

6. Literature

1. B. Gleisberg, S. Niese, *Isotopenpraxis*, 23 (1987)
2. B. Gleisberg, B.M.Ly, B. Gorski, *Actinides-89, International Conference, Tashkent, USSR*
3. S. Niese, B. Gleisberg, *J. Radioanal. Nucl. Chem., Letters*, 200 (1) (1995)

INTERNAL DOSE ASSESSMENT DUE TO LARGE AREA CONTAMINATION: MAIN LESSONS DRAWN FROM THE CHERNOBYL ACCIDENT

Andor Andrási

KFKI Atomic Energy Research Institute
Budapest, Hungary

INTRODUCTION

The reactor accident at Chernobyl in 1986 beside its serious and tragic consequences provided also an excellent opportunity to check, test and validate all kind of environmental models and calculation tools which were available in the emergency preparedness systems of different countries. Assessment of internal and external doses due to the accident has been carried out for the population all over Europe using different methods. Dose predictions based on environmental model calculation considering various pathways have been compared with those obtained by more direct monitoring methods.

ASSESSMENT METHODS

The most reliable method for internal dose assessment is based on measurement of the time course of activities in the human body. This can be performed by direct monitoring of radionuclides in the human body by the so called whole-body or partial body counting technique. Another way to determine activities of radionuclides in the body is to measure activity concentration in excreta and derive the body content considering the biokinetic behaviour of the given radionuclide. This indirect method is less accurate but in some cases it is the only possible way.

Entirely different approach is to construct mathematical models which represent the transport processes from the radionuclide release point to humans considering various environmental pathways. Fig. 1. shows the environmental compartments and processes which must be included in an assessment model representing atmospheric pathways.

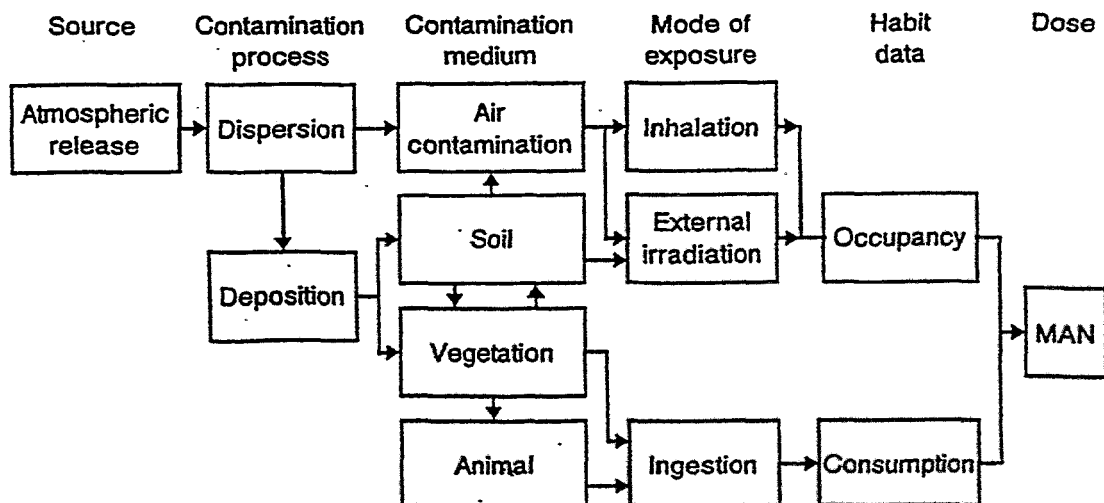

Fig. 1. Schematic representation of atmospheric pathways.

The more environmental media is monitored the more reliable calculations can be performed for activities in the human body and for received internal doses. Obviously most realistic results are expected if measured data are available for the environmental media which directly determines the human intake.

REQUIREMENTS

Since many factors are influencing the final results special attention has to be paid to reduce the possible sources of errors. In case of direct and indirect monitoring of activities in the human body the followings have to be ensured for internal dose estimation of the population:

- Representative selection of persons to be monitored (age, sex, number)
- Long term availability of persons for monitoring
- Well calibrated instrumentation (body sizes, etc.)
- Proper biokinetic considerations (excretion fraction, etc.)
- Reliable dose calculation (age dependent SEE, etc.)

If the internal dose is to be calculated by the assessment of intakes the following information is needed.

In case of inhalation:

- Indoor and outdoor air activity concentrations in time
- Physical characteristics
- Chemical form
- Occupancy
- Breathing characteristics
- Age dependent dose per unit intake factors

In case of ingestion:

- Representative sampling of foodstuffs
- Food activity concentration in time
- Food preparation
- Diet consumption habits
- Age dependent dose per unit intake factors

EXAMPLES

Numerous validation studies have been performed in national and international levels in which different model predictions were compared with experimentally observed data. The main results of two such studies are presented shortly here namely one from Hungary and an international one organized by the IAEA.

1) The whole-body counter (WBC) laboratory of the Health Physics Department investigated the temporal variation of whole-body ^{137}Cs activities in a population group of Budapest after the Chernobyl accident. Simultaneously the variation of whole-body ^{137}Cs content has been also derived from the contamination of the consumed food. The food consumption habits and food activity concentration data were collected from various sources. The calculation was performed using a simple model considering retention functions for ^{137}Cs derived from individually determined whole body potassium contents. The results obtained by this indirect method were compared with those obtained by direct WBC measurements. As it seen in Fig. 2 the results derived from food activity and consumption data generally follow the time course of WBC data but the absolute values usually differ up to a factor of two depending on the origin of foodstuff data used for the calculations.

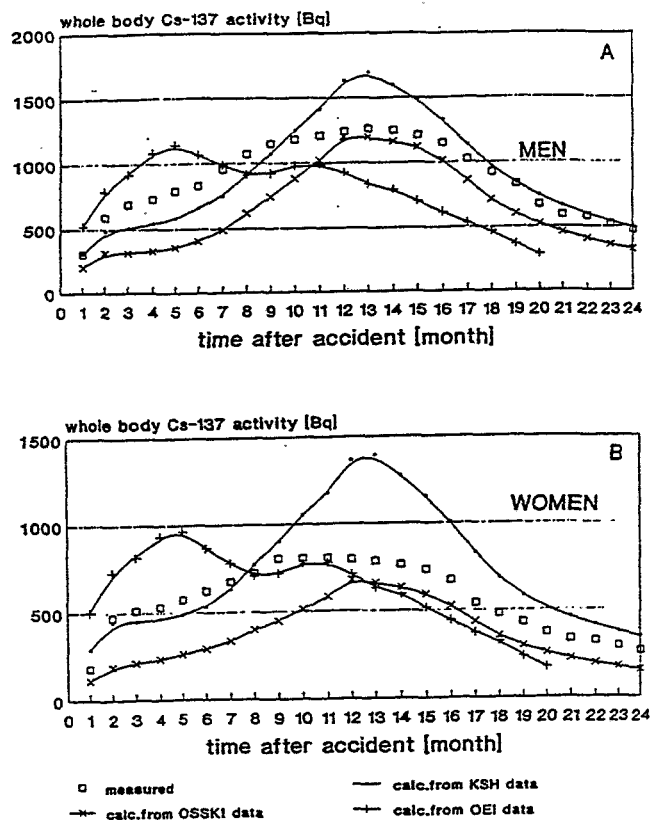

Fig. 2. (A-B) Comparison of ^{137}Cs body content determined by direct WBC measurements and predicted by food intake.

2) Validation of Environmental Model Predictions (VAMP) was a programme organized by the IAEA and CEC for testing and improving biospheric models using data from the Chernobyl fallout. In the frame of this programme one working group investigated beside others the test scenario based on data observed in Central Bohemia (CB). The participating modellers had the opportunity to compare their predictions against actual measured concentrations of radiocaesium in food products and in the bodies of the exposed population. As input data, the modellers were supplied with a time sequence of air concentrations and ground deposition along with a description of the local environmental conditions. At this time, the location of the CB region was not revealed. They were asked to predict the time variation of concentration in various food products (milk, meat) and in the bodies of the local population. Only after predictions were received by the IAEA was the information on the observed concentrations revealed. One of the results from this study is shown in Fig. 3. Predictions for internal doses due to ingestion from a number of models have been compared with those derived from the observed concentrations of ^{137}Cs in the human body for a given time period.

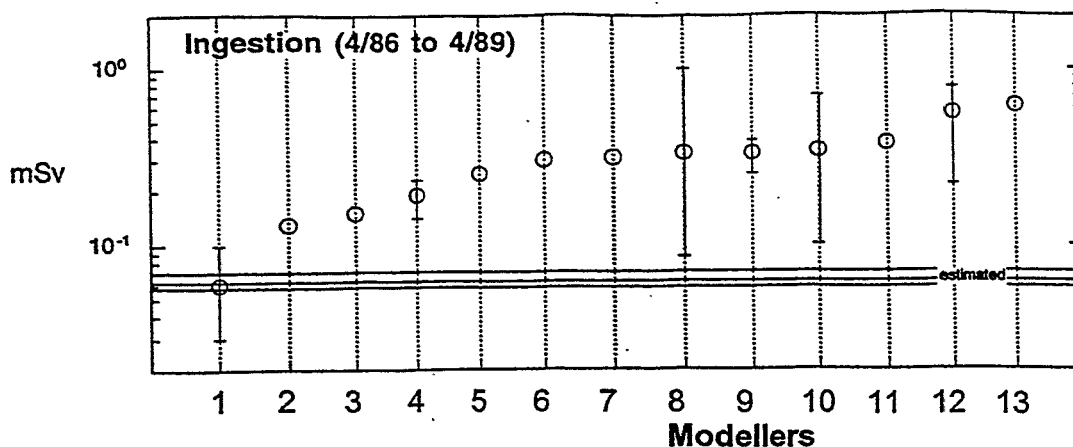

Fig. 3. A comparison of predicted versus estimated effective doses due to ^{137}Cs deposited in Central Bohemia.

As it is seen the overestimations of effective dose due to ingestion of ^{137}Cs calculated firstly by the modellers were considerably high. After making corrections in the applied models, transfer parameters, assumptions etc., the results could be essentially improved.

LESSONS

The main lessons learned from model validation studies concerning internal dose estimation can be summarized as follows

- Chernobyl accident - beside its serious and tragic consequences - proved to be very suitable for environmental model validation
- Majority of environmental transport models resulted overestimation in the predicted body activities and internal doses
- Model predictions could be improved by analysing the possible sources of differences between observed and calculated values
- Improved model predictions could be achieved by changing
 - model structure
 - transfer parameters
 - influence of seasonality
 - composition of fodder
 - characteristic human diets
 - food consumption habits
- The main sources of errors in observed activities of radionuclides in the human body are as follows
 - representative sampling of population
 - activity determination
 - human biokinetics
- Internal dose prediction is more reliable by monitoring of radionuclides in the human body than via intake calculation.

MEASUREMENTS OF LOW PHOTON DOSES USING LiF:Mg,Cu,P AND CaF₂:Cu DOSIMETERS

K. Prokert, G. Mann

Dresden University of Technology, Institute of Radiation Protection Physics
01062 Dresden

ABSTRACT

The new thermoluminophors LiF:Mg,Cu,P and CaF₂:Cu in form of pellets exhibit a significantly higher TL-response than the well-known dosimeters of the types TLD-100 (LiF:Mg,Ti), TLD-400 (CaF₂:Mn), TLD-900 (CaSO₄:Dy), etc. Furthermore, the thermoluminophor LiF:Mg,Cu,P shows besides its high sensitivity a good tissue equivalence and therefore, only a small variation of the dose response with the photon energy. The lower limits of detection of these new materials are about 5 μGy and 0.2 μGy resp. Therefore, short term measurements of absorbed dose can be realised in radiation fields at very low dose rates (environmental radiation, scattering radiation at medical equipment's etc.) with an accuracy of ± 10 %. In the field of environmental monitoring the period of exposure can be limited to about 10 days. Using CaF₂:Cu detectors an exposure of 24 hours is sufficient for dose measurements with lower accuracy. The reusability of CaF₂:Cu pellets is guaranteed without loss of sensitivity independently of the application of different reading and annealing procedures. In the case of LiF:Mg,Cu,P detectors special procedures are needed in order to keep constant TL-properties. The results of dose measurements at low dose levels in different radiation fields demonstrate the advantages of these detector types.

INTRODUCTION

LiF:Mg,Cu,P and CaF₂:Cu are new interesting thermoluminophors for individual and environmental monitoring. The material LiF:Mg,Cu,P is commercially available (Solid Dosimetric Detector and Method Laboratory Beijing, China, Nemoto & Co., Tokyo, Japan, Moscow State University, Russia and Institute of Nuclear Physics Krakow, Poland) as powder, in form of sintered pellets or fixed onto a polyimide (Kapton^R) tape [1-6]. CaF₂:Cu is a research product of the Moscow State University.

Typical properties of these thermoluminophors compared with those of LiF:Mg,Ti and CaSO₄:Dy are summarised in table 1.

The properties of these thermoluminophors result in following conclusions:

- LiF:Mg,Cu,P exhibits the advantages of TLD-100 (low γ -energy dependence) as well as CaSO₄:Dy (high sensitivity).
- The main problem using the new TL material is the decrease of the sensitivity under heat treatment at temperatures higher than 260 °C. Special reading and annealing procedures allow to avoid this disadvantage and to guarantee a reuse of these dosimeters with stable properties.
- CaF₂:Cu shows an extremely high TL sensitivity. However, this material exhibits a high γ energy dependence of the dose response.
- The UV-sensitivity of CaF₂:Cu pellets is high. Therefore, storage, irradiation and reading of the detectors must be carried out excluding this radiation.

Tab. 1 Dosimetric properties of some thermoluminophors

Property	Melted pellets of CaF ₂ :Cu	Sintered pellets of LiF:Mg,Cu,P	Chips of LiF:Mg,Ti (TLD-100)	CaSO ₄ -powder (TLD-900)
Effective atomic number	16,3	8,2	8,2	15,3
Relative TL response	100	10...40	1	25
Gamma-energy dependence (normalised at 662 keV)	max. overestimation factor 30	max. overestimation factor 1,1...1,3	max. overestimation factor 1,4	max. overestimation factor 25
Lower limit of detection	0,2 µGy	5 µGy	50 µGy	10 µGy
Range of linear response	up to 10 Gy	up to 10 Gy	up to 5 Gy	10 ³ Gy
Reusability	possible without special treatments	special thermal procedures necessary	special thermal procedures necessary	possible without special treatments
TL fading within 6 month	4 %	4 %	5 %	1 %
Influence of UV light or chemoluminescence	strong effect of UV radiation	hardly measurable	strong effect of chemoluminescence	strong effect of UV radiation

MATERIAL AND MEASUREMENTS

The investigations were carried out using LiF:Mg,Cu,P- and CaF₂:Cu produced by the Chemical Institute of the Moscow State University (MGU). The characteristics of the detectors are given in Tab. 2.

Tab. 2 Properties of CaF₂:Cu and LiF:Mg,Cu,P detectors (MGU products)

Property	CaF ₂ :Cu vitreous pellets	LiF:Mg,Cu,P sintered, white pellets
Diameter of the pellet	4,8 mm	4,8 mm
Thickness	1,0 mm	0,95 mm
Mass	50 mg	40 mg
Density	2,8 gcm ⁻³	2,3 gcm ⁻³

Measurements of the glow curves were performed after irradiation with Cs-137- γ -rays (reference dose 1 mGy) using a HARSHAW-4000-reader (Heating rate 4 Ks⁻¹, N₂-atmosphere). Fig. 1 shows the glow curves measured. The standard annealing of LiF:Mg,Cu,P was performed in a furnace at 240 °C for 5 min, followed by rapid cooling to room temperature. The loss of TL sensitivity is negligible if this annealing temperature is used. The necessity of avoiding high annealing temperatures and long heating periods means, however, that keeping of the IEC rule for dosimeters of type E (environmental monitoring) is hardly possible. Typical values of residual TL signal are about 0.5 % instead of 0.2% required after the IEC rule. In the case of CaF₂:Cu the annealing was carried out in the temperature range of 300 to 450 °C for app. 10 min. For this material the IEC requirements for dosimeters of type E are fulfilled.

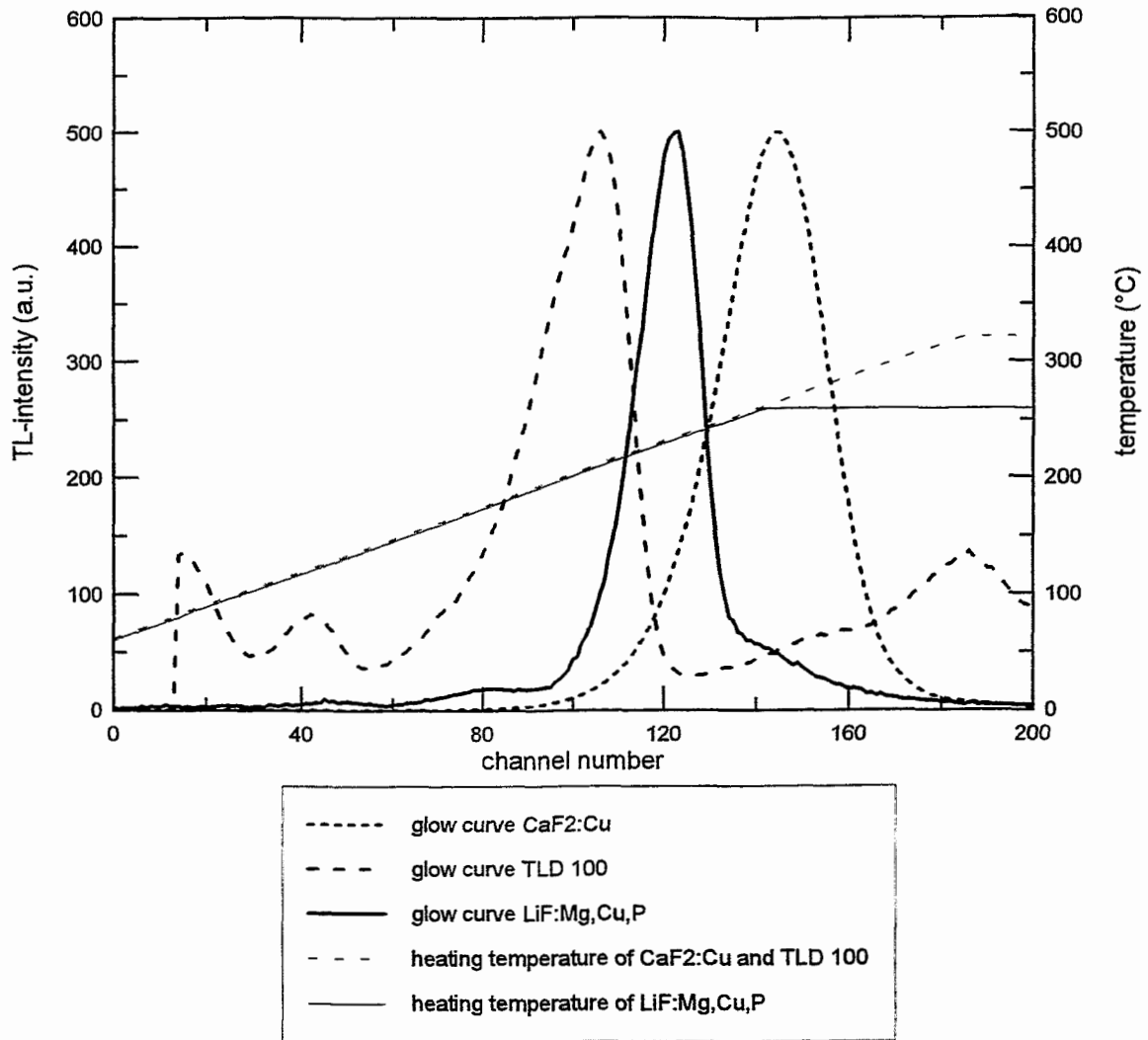

Fig. 1 TL glow curves of LiF-TLD-100, LiF:Mg,Cu,P- and CaF₂-Cu-pellets.

A special annealing process is not necessary if dosimeters are irradiated at low doses (< 1 mGy). In this case the reading procedure followed by an additional heating (15 sec) at readout temperature extinguishes the previous TL signal completely.

The dose characteristics of both TL materials are linear up to 10 Gy. Above this value a saturation effect appears for LiF:Mg,Cu,P; supralinearity is not observed. The lower limit of detection (the integrated signal in the peak region has to be 3 times higher than the 2σ deviation of the background) amount to $0.2 \mu\text{Gy}$ for CaF₂:Cu and $5 \mu\text{Gy}$ for LiF:Mg,Cu,P. These low values enable screening measurements with periods of exposure of only a few hours in environmental radiation fields (average dose rate in Germany about $0,1 \mu\text{Gy/h}$) in order to find areas with abnormal high dose rates. Dose values are available after a few days with an accuracy of app. $\pm 10\%$.

IMPACT OF THE DIFFERENT γ ENERGY DEPENDENCE OF LiF:Mg,Cu,P AND CaF₂:Cu ON THE DOSE ESTIMATION IN VARIOUS RADIATION FIELDS

The strong variation of the dose response on the photon energy is a disadvantage of CaF₂:Cu-detectors in comparison to LiF:Mg,Cu,P. This dependence must be taken into consideration when energies of photons used at the calibration and those of the real radiation fields differ significantly. The following evaluations were carried out to quantify this impact on the dose estimation.

The distribution of the energy flux density in different materials (air, soil etc) caused by typical sources (K-40, U238 resp. Th-232 and daughters) was calculated by the Monte Carlo-Programm AMOS [7] (see fig. 2). Assuming a detector calibration in a monoenergetic 662 keV photon field and using the energy response functions of the detector materials CaF₂ and LiF the overestimation of the absorbed dose in typical radiation fields was calculated (see Tab. 3).

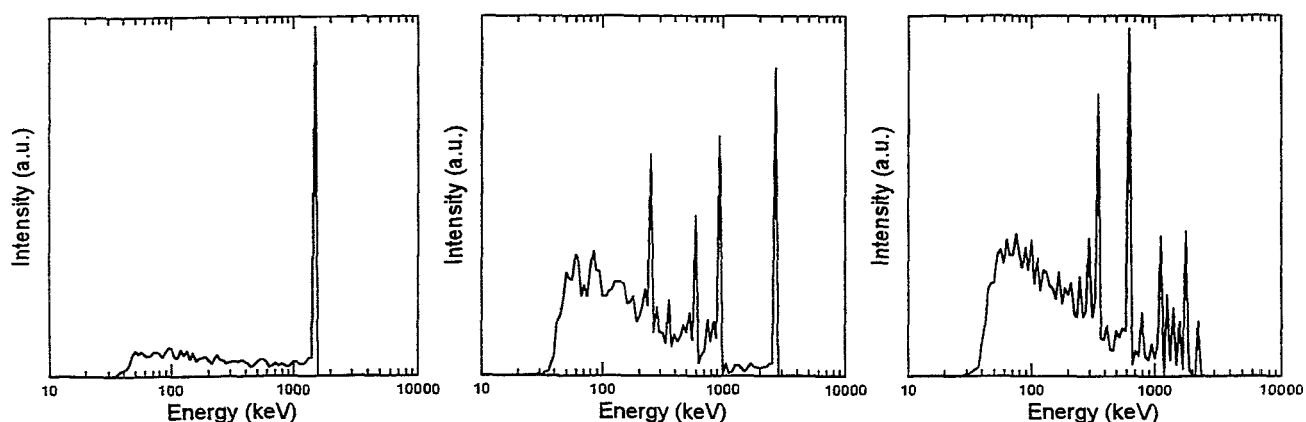

Fig.2 A,B,C

Calculated energy flux density of photons at the measuring point 1 m above ground, caused by homogeneous distributed K-40 (A), Th-232 (B) and Ra-226 (C) in the soil

Tab. 3 Overestimation of absorbed dose in radiation fields corresponding to figure 2. (Calculated for TL detectors calibrated in a monoenergetic 662 keV radiation field)

Material	662 keV	K-40	Th-232	U-238
CaF ₂	1	2,74	3,26	3,30
LiF	1	1,03	1,04	1,04

Measurements carried out under free air conditions as well as in soils have shown a smaller overestimation than pointed out in Table 3. This is caused by the simple assumption of a monoenergetic radiation field in the calibration which is not realized in practice. CaF₂:Cu dosimeters calibrated at the Cs-137 source of the Institute of Radiation Protection Physics (unfiltered beam with a significant part of scattered photons) show a factor of overestimation in environmental radiation fields in the range between 1.2 and 2.

In environmental radiation fields the measurements simultaneously performed using CaF₂:Cu and LiF:Mg,Cu,P resulted a significantly higher „CaF₂ doses“ at low dose rates compared with those of the practically energy independent LiF-material (fig. 3). This effect can be explained by the following assumptions:

- In environmental fields characterized by „low“ dose rates the contribution of low energy photons is high which are produced by secondary cosmic radiation.
- In environmental fields characterized by „high“ dose rates the contribution of photons with higher energies dominates which are produced by radiation sources in the surroundings.
- The consequence is a higher factor of overestimation using CaF_2 detectors.

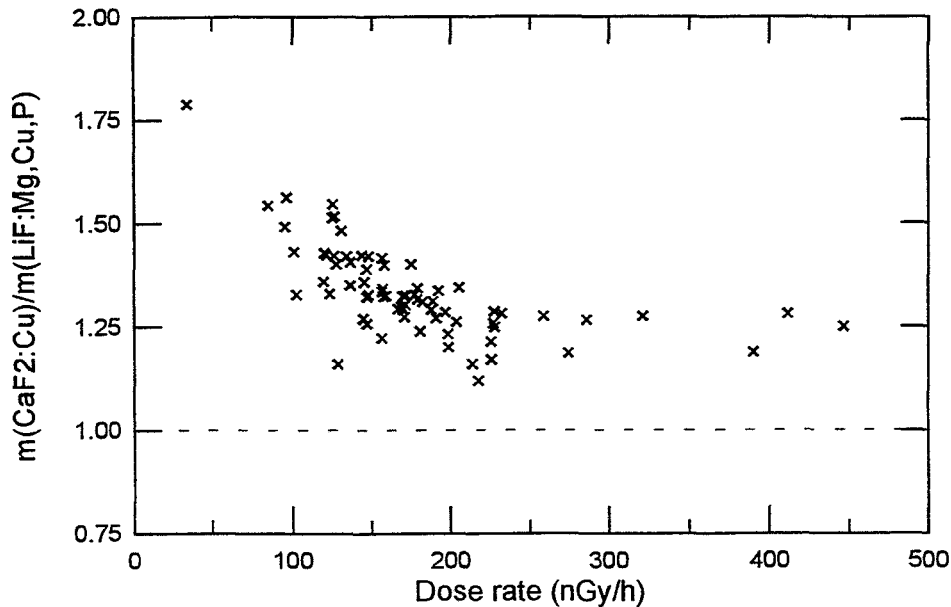

Fig. 3 Relation between LiF:Mg,Cu,P and $\text{CaF}_2\text{:Cu}$ TL readings

RESULTS OF DOSE MEASUREMENTS IN VARIOUS RADIATION FIELDS

Both detector types were used for dose measurements in the following radiation fields:

- Former uranium mining area Königstein
- Soils with high specific activity in Zwickau/Crossen
- Soils with low specific activity in Hessen
- Laboratories of the TU Dresden
- Dwellings in the town Freital

Some typical results are presented in Tab. 4.

CONCLUSIONS

The LiF:Mg,Cu,P - and $\text{CaF}_2\text{:Cu}$ -TL-detectors are suitable for dose measurements at low dose levels. Especially $\text{CaF}_2\text{:Cu}$ pellets exhibit extremely high TL sensitivity and, furthermore, an excellent thermal, chemical and mechanical stability. A disadvantage is its high photon energy dependence of the dose response. The main advantage of new high sensitive LiF:Mg,Cu,P dosimeters is the small variation of the dose response with the photon energy. The poor thermal stability permits a careful handling of this material during reading and annealing.

In fields with unknown γ energy distribution LiF dosimeters must be used because an application of the CaF_2 type results in an overestimation of the dose. However, the factor of overestimation can be calculated if the photon energy spectrum is known.

Tab. 4 Results of measurements using LiF:Mg,Cu,P and CaF₂:Cu
(For each measuring series one typical result is given)

	TU Dresden ¹⁾	Freital, dwellings	Hessen, clay soil	TU Dresden ²⁾	Königstein, mining dump	Crossen, deposit of unknown origin
Detector material	LiF:Mg,Cu,P	LiF:Mg,Cu,P	LiF:Mg,Cu,P	CaF ₂ :Cu	CaF ₂ :Cu	CaF ₂ :Cu
Measuring task	Determination of H*(10)	Determination of H*(10)	Determination of absorbed dose in soil	Determination of H*(10)	Determination of H*(10)	Determination of activity of soil
Period of measurement (days)	7	30	75	0.5	10	14
Transport dose	negligible	8 µGy	25 µGy	negligible	3 µGy	2 µGy
Number of detectors	3	3	3	5	3	3
Dose rate (nGy/h)	220 ± 30	140 ± 10	30 ± 5	110 ± 20	125 ± 5	1600 ± 100

¹⁾ Laboratory with ²²⁶Ra source

²⁾ Laboratory without radiation sources

Only in this way one can profit by the extremely high TL response of this material for exact dose measurements.

Summarizing, it can be concluded that LiF:Mg,Cu,P detectors seem to be the most suitable thermoluminescent material for determination of H*(10) in radiation fields at low dose rates. For the purpose of short term screening measurements CaF₂:Cu is doubtless one of the best TL-detector material available at present.

REFERENCES

1. Wang, S., Chen, G., Wu, F., Li, Y., Zha, Z. and Zhu, I. *Newly Developed Highly Sensitive LiF:Mg,Cu,P-TL-Chips with High Signal Noise Ratio* Radiat. Prot. Dosim. **14** (3) 223-227 (1986)
2. Nakajima, T., Murayama, Y., Matsuzawa, T., and Koyano, A. *Development of a New Highly Sensitive LiF Thermoluminescence Dosimeter and its Applications.* Nucl. Instr. Methods **157** 155-162 (1978)
3. Prokert, K., Fellingner, J., and Karpov, N. *Eigenschaften von LiF:Mg,Cu,P-TL-Detektoren für die Umweltüberwachung* Fortschritte im Strahlenschutz FS-91-55-T (Proceedings der FS-Tagung in Aachen 30.9.-3.10.1991) S. 789-793
4. Zha, Z., Wang, S., Shen, W., Zhu, J. and Cai, G. *Preparation and Characteristics of LiF:Mg,Cu,P Thermoluminescent Material* Radiat. Prot. Dosim. **47** (1/4) 111-118 (1993)
5. Bacci, C., Angelot, L. D., Furetta, C. and Giancola S. *Comprehensive Study on LiF:Cu,Mg,P (GR-200 A)* Radiat. Prot. Dosim. **47** (1/4) 215-219 (1993)
6. Delgado, A., Gomez Ros, J.M. and Muniz, J.L. *Computerized Analysis of LiF GR-200 Signals: Application to Dose Measurements in the µGy Range* Radiat. Prot. Dosim. **60** (2) 147-153 (1995)
7. Henniger, J. *AMOS - ein multivalent nutzbares Programmsystem zur Berechnung von Strahlungstransportproblemen* Fortschritte im Strahlenschutz FS-94-71T (Proceedings der FS-Tagung in Karlsruhe 24.5.-26.5.94) S. 145-150

PARAMETERS OF A SIMPLE WHOLE BODY COUNTER AND THYROID MONITOR ESTABLISHED AT THE DRESDEN FELSENKELLER UNDERGROUND LABORATORY

P. Sahre, Th. Schönmath

Rosendorf Nuclear Engineering and Analytics Inc.
P.O.B. 510119, 01314 Dresden, Germany

Abstract

At the Rosendorf Nuclear Engineering and Analytics Inc. a simple whole body counter and a Iodine - thyroid monitor are used for measuring the internal contamination of workers. There is no shielding chamber in both cases.

By using the chamber at the Dresden Felsenkeller underground laboratory the lower limit of detection could be improved by a factor of about 3 for whole body counting and by a factor of 2,5 for thyroid monitoring (I 131, I 125). Concerning the lower limit of detection the applicability of the German standard DIN 25 482 implemented in the Gamma-Vision software package is discussed in the paper.

1. Introduction and equipment

Whole body counter

Since 1976 a whole body counter (WBC) has been used at the Rosendorf Research Centre for measuring the internal contamination of workers.

The WBC is a shadow shield type with a tilted chair having only one detector.

In 1991 a HP Germanium detector was substitute for the old NaI (TI) detector (3"x3")¹⁾.

Table 1 contains the parameters of the WBC.

Table 1: Parameters of the Rosendorf Research Centre whole body counter

Type:	shadow shield, tilted chair geometry
Dimensions:	width 0,9 m, length 2.0 m, height 1,5 m
Shielding:	0,12 m old iron, separate detector Pb-shield, shielding factor (integral 60 keV and 2 MeV): 14.3
Positioning the person:	Position the person on the pulled-out tilted chair, push in the chair, position the detector above the chest of the person (distance detector - body central axis about 0.4 m)
Detector:	HP GE detector (n-type), efficiency 43 % fwhm = 1, 49 keV (662 keV) 1,95 keV (1332 keV)
Measuring time:	2000 s
Spectrum analysis:	4096 channels, spectrum analysis by means of OMNIGAM

In figure 1 the WBC is given schematically.

Due to the extension of the measuring aid to non occupationally exposed persons, i.e. country people, an improvement of the lower limit of detection was very welcome. This improvement was realized by the use of the Dresden Felsenkeller underground laboratory as a measuring chamber for the whole body counter geometry mentioned above but without shadow shield as given in figure 2.

Thyroid monitor

In 1994 a HP Germanium detector was substitute for the 2,5"x1,5" Na (Tl) detector too for the thyroid monitor.

Table 2 contains the parameters of the thyroid monitor.

Table 2: Parameters of the Rossendorf thyroid monitor

Type:	chair geometry, detector collimator
Measuring position:	collimator touches the neck, distance neck to detector surface 4,5 cm
Detector:	HP Ge detector (n-type) efficiency 43 % fwhm = 1, 49 keV (662 keV) 1,95 keV (1332 keV)
Measuring time:	200 s
Spectrum analysis:	4096 channels, spectrum analysis by means of OMNIGAM

The desirable improvement of the lower limit of detection was done by using the Dresden Felsenkeller whole body counter with a special fixture of the detector, i.e. the detector is not fix mounted and can be directed to the thyroid gland.

2. Lower Limit of Detection

Whole body counter

The lower limit of detection (decision level, i.e. Erkennungsgrenze in the German standard 25 482/2 ²⁾) of the Rossendorf WBC is for instance 35 Bq for Co 57, 20 Bq for Cs 137 and 17 Bq for Co 60.

In figure 3 the improvement is shown due to the use of the Dresden Felsenkeller underground laboratory. The improvement is about 100 per cent for high energies and up to 300 % in the region of about 100 keV, i.e. about 10 Bq for Co 57 and for Co 60.

Figures

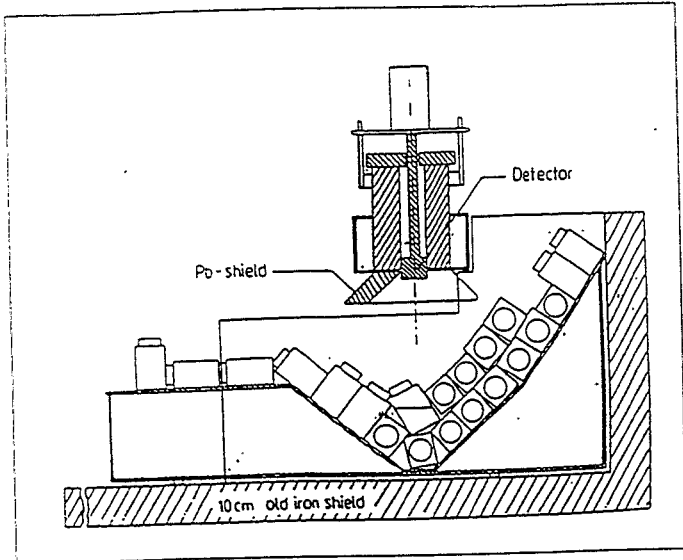

Fig.1: Schematic graph of the Rossendorf whole body counter

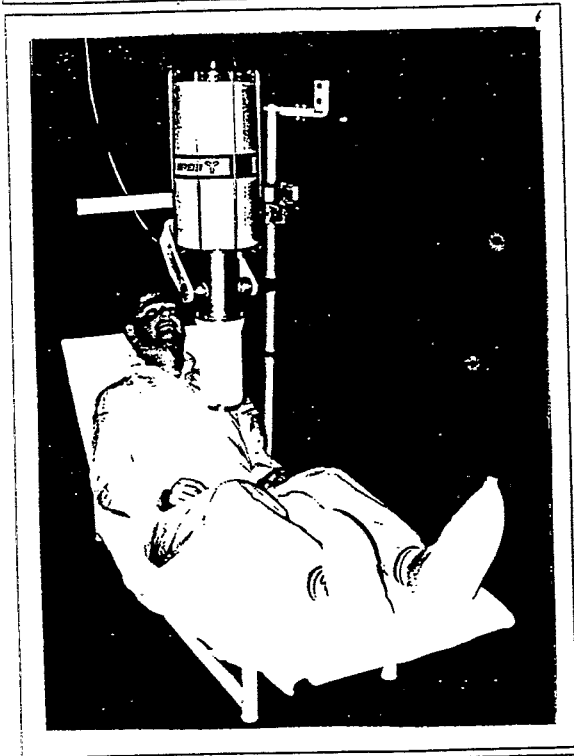

Fig. 2: Measurement in the Dresden Felsenkeller underground laboratory

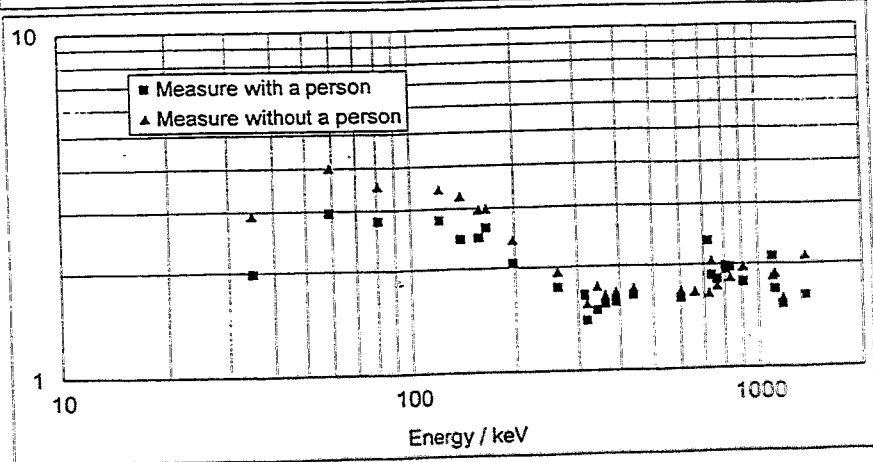

Fig. 3: Ratio of LLD Rossendorf WBC and Felsenkeller WBC

Thyroid monitor

In table 3 the decision limit of the thyroid monitors located at Rossendorf and at the Dresden Felsenkeller underground laboratory are given.

Table 3: Comparison of the LLD of the thyroid monitors located at Rossendorf and Dresden Felsenkeller underground laboratory (measuring time 200 s)

Nuclide	LLD Rossendorf [Bq]	LLD Dresden [Bq]
I 125	9	4
I 131	10	4

3. Discussion of the lower limit of detection

The lower limit of detection used in the chapter 2 was the decision level (in German: Erkennungsgrenze) corresponding to the German standard DIN 25 482/2. The calculation of the values was carried out by using the EG&G software packadge OMNIGAM or Gamma-Vision.

3 persons were measured using the Rossendorf WBC and the Dresden Felsenkeller WBC. We got no Cs 137 activity from the Rossendorf WBC. The decision level was about 20 Bq.

The 662 keV peak was first found but after this neglected because of the bad peak shape. But using the Dresden Felsenkeller WBC we detected in all persons a Cs 137 activity of about 50 Bq.

The conclusion is, that the calculated decision level is too low.

Summary

The lower limit of detection for the Rossendorf whole body counter and the Rossendorf thyroid monitor was improved by up to a factor of 3 and 2 resp. by the only use of the measuring chamber of the Dresden Felsenkeller underground laboratory.

References

- 1) P. Sahre, Th. Schönmath, K. Thieme
Results of Substituting the NaI by a Ge detector in a Simple Shield Whole Body Counter in Proceedings of the Fourth Conference on Radiation Protection and Dosimetry, Orlando, Florida, Oct. 23-27, 1994, p. 327 - 335
- 2) DIN 25 482, Teil 2, Nachweisgrenze und Erkennungsgrenze bei Kernstrahlungsmessungen, September 1992

V. Low-Level LSC-Techniques

Chairperson: P. Theodorsson

Low-Level Measurements with Liquid Scintillation Spectrometry Development and Application

Franz Schönhofer
Federal Institute for Food Control and Research
Vienna, Austria

Development

Liquid scintillation spectrometry (LSC) is a relatively new technique. Originally it was mainly used for determination of low-energy beta emitters (tritium and C-14). Applications were limited not only due to the relatively simple electronics, but also due to restrictions in usable cocktails and vials. Low-level measurements were not possible due to the inherent high background and low counting efficiencies with the cocktails available, but they were actually not needed. Most applications of LSC were in clinical chemistry and biological research, where tritium and C-14 were used as tracers in large amounts, simple to measure. In the environment levels of tritium and C-14 as well as for other radionuclides were high due to the atmospheric nuclear bomb tests and also easily measurable by other techniques.

Techniques like age determination by C-14 and increased concern about radionuclides in the environment as well as more restrictive legislation on maximum permissible concentrations resulted in a demand for lower lower limits of detection. New electronics, use of low potassium glass vials and later polyethylene vials as well as development of gelforming cocktails improved the range of applications and the lower limit of detection (LLD).

About 20 years ago much work started to be done using LSC, first for easy, fast and reliable measurements of high activity concentrations of various radionuclides, but then extending the range of measurement to lower concentrations, using efficient concentration steps. Routine measurements for Sr-90 and for alpha-emitters like Rn-222, Ra-226 etc. were introduced. Experience from gamma-spectrometry influenced the users demand for new techniques like MCA technique to identify radionuclides and control of the spectra for interferences or the possibility to adjust counting windows for optimization.

Instruments with active shielding had already been built at research institutes when thirteen years ago an instrument with active shielding, using a liquid scintillator in a tank surrounding the measurement cell as a shield, became commercially available („Quantulus“, Wallac OY). A massive shielding of selected lead and construction material checked for its radioactivity reduced the background further. MCA technique is used and the control of the instrument is done by PC. Later alpha-beta separation became available on the same instrument. Some years later another company (Packard Instrument) used electronic means to reduce the background. The PERALS system offers a relatively simple device to measure alpha-emitters at low concentrations.

LSC has the big advantage over most other methods of a 4π geometry and therefore high counting efficiencies for both beta and alpha emitters. Sample preparation is in most cases easy and there is no self absorption to correct for. Many extraction methods can be used to give a solution ready to count. With the PERALS system suitable and specific crown ethers dissolved in a toluene based liquid scintillation cocktail are used as „extractive scintillators“

which can be measured immediately after extraction. A new, commercial separation system („EiChrome“) uses crown ethers on a resin matrix and the number of its applications published and used in routine analysis is rising steeply. Very often the final measuring step uses LSC.

The low background can be useful in many ways: Very low levels of radionuclides can be determined. Accuracy can be enhanced or measurement time can be shortened. Small samples can be used and therefore chemical separations can be simplified and shortened. Costs for chemicals and personell will also be reduced.

Applications

Since the availability of a commercial low-level counter a large number of applications has been introduced, many well known applications have been improved. Here only a few typical examples can be given - mostly work done in the authors laboratory. The instruments used were the „Quantulus“ from Wallac Oy, Finland (we have four of them), vials were in nearly all cases PTFE-coated PE vials from Zinsser, Germany and the cocktails used were from Zinsser, Germany and Packard Instrument BV, Netherlands. All LLD's mentioned in this paper are based on 3 sigma of the background for a 500 min count.

Tritium in Water

The measurement of tritium was one of the first applications for LSC. Environmental levels of tritium for instance in precipitation were easy to measure because of the large amounts of tritium which were present in the atmosphere due to the atmospheric nuclear bomb tests. After the moratorium 1962, the concentration of tritium declined. About 15 years ago the concentration in precipitation was approaching values in Middle Europe which were close to the LLD of then very good LSC instruments, namely 20 TU (2.4 Bq/l). With the „Quantulus“ it was possible to reach with special teflon vials with massive copper cap a figure of merit of approximately 1500 and an LLD of 5.4 TU (0.65 Bq/l). With standard PTFE coated, disposable vials and the same mixture of 8 ml water and 12 ml cocktail (Quickszint 400, Zinsser) still a figure of merit of 1008 was found. Recent comparisons of different cocktails showed that even among very well suited cocktails a difference of more than 40 % for the LLD is possible. Mixing ratios play another important role. These findings show that there are some critical factors, which have to be tested extensively in order to optimize a measurement and to reach the minimum LLD for a given instrument, like type of cocktail and mixing ratio.

Tritium in Urine

In many nuclear installations tritium may be liberated. Persons working in exposed areas are likely to incorporate tritium and have therefore to be monitored. The easiest way to do it, is to monitor urine.

Urine is usually a highly coloured liquid and therefore a ratio of 8 ml urine and 12 ml cocktail would yield a solution, which would show an enormous quench. Efficiencies for tritium as low as 0.25 % have been recorded. Distillation of the urine would yield a clear liquid, but all OBT would be lost. We have therefore chosen to use only 1 ml of urine and to dilute it with tritium free water to 8 ml. The quench of the resulting solution is rather low and efficiencies

between 14 and 24 % have been measured. The low background still allows for sufficiently low LLD's. Efficiency is determined by the internal standard method. We used this procedure to measure tritium in urine of occupationally exposed persons.

Another application was the question of incorporation of tritium from wrist watches with luminous dials. We could easily follow the uptake of tritium through the skin and assess the dose due to incorporation of tritium from wrist watches. The emission of the watches was easy to determine by placing them into a closed jar with water. Radioactive material in consumer products is of concern, though in this case the dose was extremely low. Nevertheless it is unnecessary if following the ALARA principle.

Tritium was also determined very accurately in alcoholic beverages. Together with the activity concentration of C-14 it is possible to date the time of harvest of the wine.

Carbon-14

The use of C-14 for determination of the age of archeological samples is well known. The use of low-level LSC counters has extended the range of possible age determinations considerably.

But C-14 is of interest also in other fields. C-14, originating from atmospheric nuclear weapons testing has been distributed in the atmosphere. The C-14 contamination of the environment can easily be determined by measuring the C-14 activity concentration in products from photosynthesis. We chose wine, which reflects both tritium and C-14 concentrations in the atmosphere by their concentration in both the fermentation product alcohol and in water. C-14 has a characteristic calibration curve as well as tritium and its concentration can therefore be very well used for age determination of the wine in question. Low-level LSC can be used to control correct labelling of the age of wine.

Acetic acid produced from natural gas contains no C-14 since the C-14 present at the formation of natural gas has decayed since long. Adulteration of vinegar has been a frequent problem. Vinegar made from wine contains the contemporary concentration of C-14, vinegar produced from wood contains a typical other (higher) concentration and vinegar from ethylene contains no C-14 at all. By determining the C-14 concentration of vinegar it is possible to find out about adulterations of „wine vinegar“.

Strontium-90

Sr-90 is a fission product, a pure beta emitter with E_{max} 0.5 MeV, which decays to Y-90 with a high beta-energy of E_{max} 2.3 MeV. Since Sr-90 is a bone seeker it contributes to the dose to bone marrow considerably and therefore its determination is of great interest.

Usually Sr-90 was determined after a very lengthy chemical separation, using big amounts of fuming nitric acid, which was both costly and unhealthy for the technicians.

Using low-level LSC it is possible to use small amounts of sample. The chemical separation can be simplified, the amount of fuming nitric acid and other chemicals can be kept low, thus

reducing the costs of the determination considerably. Certain steps of the traditional determination method for removal of interfering radionuclides like Ra-226 cannot be avoided, but separations are easily performed in centrifuge glasses, when small sample sizes are investigated.

This method can be used in emergency situations and in retrospective analysis of environmental samples. One of the applications in the authors laboratory was the determination of Sr-90 in food after the Chernobyl accident, with emphasis on milk and milk products but other applications are for instance the retrospective environmental contamination situation using bioindicators like red deer antlers.

Alpha-emitters

It was known since long, that alpha-emitters can be measured by LSC, but routine applications were scarce. One of the most important application was and still is the determination of Rn-222 and Ra-226 in drinking water, as well as Rn-222 in air.

Alpha-emitters have a counting efficiency in LSC of approximately 100 %. This is the big advantage over solid state spectrometry. The big disadvantage is the relatively poor energy resolution.

A very specific determination method for Rn-222 in water is the extraction of Rn-222 into a water immiscible LSC cocktail. Ultra low-level LSC is able to detect very low concentrations, but naturally occurring concentrations have never been below an LLD.

After decay of unsupported Rn-222 in the sample any Rn-222 present must be due to the equilibrium with Ra-226. This is the basis for determination. The original water sample is mixed with the water immiscible cocktail. The value recorded a short time after mixing is representative for Rn-222. After waiting long enough for decay of unsupported radon all radon present must be in equilibrium with Ra-226 - so Ra-226 can be determined. Thousands of samples have been analysed, giving very valuable hints for the radon potential in certain areas. The concentration of Ra-226 in drinking water is regulated very strict in Austria to 0.112 Bq/l of Ra-226 in water. The LLD for a 500 min count is with our conditions <0.03 Bq/l. Therefore the analysis for these levels can be done by pipetting 10 ml of water, 10 ml of water immiscible cocktail, shaking and two measurements. This seems to be the most simple analysis method imaginable.

Large programmes have been carried out to determine the Rn-222 contamination in indoor air by using a special device with a charcoal radon sampler and LSC as the measurement device.

Conclusion

A few applications of low-level LSC have been mentioned, showing the typical advantages over conventional LSC. For more information reference is made to the literature. Without doubt LSC has been used successfully and further applications are to be expected. LSC has already or will replace many methods using gas-flow counters or geiger counters.

SPECTRUM LIBRARY CONCEPT AND PULSE SHAPE ANALYSIS IN LIQUID SCINTILLATION COUNTING

Lauri Kaihola

Wallac Oy, P.O. Box 10, FIN-20101 Turku, Finland

Abstract

Wallac introduced in 1990 a new absolute liquid scintillation counting (LSC) method, Digital Overlay Technique (DOT) to correct for quench. This method allows quantization of multilabel samples by referring to library spectra which are generated against chemical and color quench indices at the factory. The libraries can further be expanded to any beta emitter by user with a method called fine tuning, which can be carried out even with a single sample. Spectrum libraries are created over the whole spectrum range of the radionuclide and allow automatic identification of a single label beta emitting radionuclide, called Easy Count method.

Another improvement in LSC is commercial introduction of Pulse Shape Analysis (PSA) in 1986 by Wallac. This method recognizes alpha particle decay by pulse shape and leads to excellent sensitivity in alpha counting because most of the background signal in LSC comprises of short or beta like pulses. PSA detects alpha events in the presence of high excess of beta activity over alphas, up to a ratio 100000 to 1.

Quench Problem and Methods to Correct for Quench in Liquid Scintillation Counting

Liquid scintillation counting (LSC) faces a quench problem, because the detector is the sample itself, prone to variable chemical and color quench. These quench effects mean photon losses occur by chemical or absorption processes, respectively.

Standardization methods have been applied in past for single label samples where count rates in two fixed windows over the spectrum have been recorded to monitor the variable quench. The ratio of count rates in these two windows is independent on the total activity in the sample and it is a good measure of the spectrum shift by quench. This Sample Channels Ratio (SCR) has been used successfully as a quench index to obtain absolute activities [1].

Analogous to SCR is the External Standard Channels Ratio (ESCR). In this case a gamma emitting capsule is placed near to the scintillation vial. Compton are produced then in the sample and their spectrum shifts in the similar way to that of beta radiation. The main advantage of the Compton spectrum quench monitoring is that high statistical confidence is achieved rapidly.

Multichannel analyzer (MCA) technology adapted in LSC in the beginning of 80's allowed a more sophisticated measures of quench: Spectral Quench Parameter of the external standard or SQP(E). This parameter is effectively the end point of the external standard Compton electron spectrum. Some clear advantages over the ESCR were achieved as greater quench range and independence on plastic vial effect.

Two label counting can be carried out by designating one fixed counting window for each radionuclide and using SQP(E) as the quench index. Two sets of standards are used for reference efficiency vs. quench curves. This method may produce poor results when there is high excess of one radionuclide over the other or the quench is very high.

New approach to overcome problems of the above method was developed by applying three windows over two label spectra [2-3]. This Three over Two method then needed 3 standard curves for each radionuclide over the quench range of interest. A set of three equations for two unknowns was solved by least least squares optimization to obtain the best fit to data. The method included also Accuracy Enhancement: A better value for SQP(E) around the measured one is searched numerically to find a better fit than calculated with the measured SQP(E). A shorter external standard counting time was then acceptable which lead to higher throughput of samples.

Introduction of dual MCA in 1984 by Wallac allowed an important additional correction to be made in LSC standardization procedure, viz. color correction [4-5]. Because the decaying atom is mostly located asymmetrically with respect to the vial axis, the presence of color in the sample results in pulse amplitude disparity in the two phototubes. The degree of disparity is assessed in Wallac LS counter by Pulse Amplitude Comparison (PAC). If the disparity is small in comparison with the set criterion, the summed pulses are fed into the first MCA. If, however, the disparity is large the pulses are fed into the second MCA. From the ratio of the two Compton spectra one can calculate the Color Index.

Quench Correction in Liquid Scintillation Counting by Digital Overlay Technique

The Three over Two method was further expanded into Digital Overlay Technique (DOT) to solve activities of multilabel samples in LSC. The method was introduced in 1990 by Wallac. Two quench indices are used in the method: SQP(E) as the measure of total quench and color index to measure physical absorption of light in the sample. Library quench data is a basis for user's own quench calibrations and an overlay, ie. fitting the reference spectra to the measured one is a way to retrieve maximum information about the measured spectrum [6-10].

DOT is based on the experimental verification of the hypothesis that more windows are better than two or three. The precision of the results improved steadily as the number of windows increased, in DOT up to 15. Instead of quench curves, efficiency surfaces are contained in DOT as function of color and chemical quench (Fig. 1). The stored quench data describe the behavior of complete spectra. For each radionuclide of interest, the normalized reference spectra are stored as a function of quench. Any single label quench data can then be combined when doing multilabel counting. No separate single label and dual label calibrations are necessary as before.

Built-in spectrum libraries are created at the factory for 6 radionuclides with 60 – 80 reference standards for each one: H-3, I-125, C-14, S-35, Ca-45 and P-32. Separate libraries are made for glass and plastic vials and for xylene type and safe type cocktails. A direct single button, Easy Count operation is thus available for these cases and the counter will automatically identify the radionuclide. A library can be fine tuned to match any other type of sample containing these radionuclides using just a single reference sample. New libraries can be created for any other beta emitter using up to 10 reference samples in the quench set. Up to three labels can be counted simultaneously with the DOT method. Method further contains Accuracy Enhancement, chemiluminescence correction using delayed coincidence circuitry to truly detect random coincidence events, decay correction, background correction and sample quality monitor to monitor the perfection of fit of data to the library spectra. External standard was chosen to be Eu-152 because its dynamic range for color correction was better than that of Cs-137. Automatic continuous spectrum stabilization is continuously applied during counting with the aid of a light emitting diode. The aging of diode does not affect the stabilization as the high voltage is controlled by the ratio of signals from first and second dynodes of the phototube (ACSS Plus).

A good demonstration of the DOT to handle multiple label samples is its ability to tell apart C-14 and S-35 from a mixture even though the maximum energies of these radionuclides differ only by 12 keV (155 and 167 keV, respectively).

Pulse Shape Analysis

Alpha particles emit 5 MeV or more energy which is able to create triplet states in solvent which de-excite to ground state slower than singlet states produced by beta particles. Measurement of the pulse decay time or length allows identification of the particle which caused it and enables simultaneous recording of pure alpha and beta spectra, respectively.

Wallac named this feature Pulse Shape Analysis (PSA) and introduced it first for commercial liquid scintillation counters in 1986 [11].

Wallac PSA Principle

- Integrates the tail of the pulse for long enough time to enable differentiation between short and long pulses (Fig. 2).
- Normalizes the pulse length information to the pulse height to achieve amplitude independence.

Alpha/beta pulse amplitude (energy) spectrum is transformed in the process to a three dimensional counts vs. pulse amplitude and pulse length spectrum (Fig. 3). Electronic division of pulses into alpha and beta spectra is carried out by dividing the pulse amplitude/length plane in two parts by a straight, user adjustable line: pulses above it are directed into the long pulse spectrum, pulses below it into a short pulse spectrum. When dividing line is correctly set, former spectrum is the pure alpha spectrum and the latter one is the beta spectrum. The position of the dividing line is controlled by PSA level adjustment. This feature allows setting to confirm with various solvents, fluors and quench levels.

Wallac PSA Excellency

- Operates simultaneously with and independently on the anticoincidence guard detector from which sample detector is optically isolated. Ultra low level counting mode is thus enabled in the presence of PSA.
- Wallac PSA works very well with both fast and slow cocktails without need to add naphthalene to make the pulse slower (fast cocktails contain volatile solvents such as xylene, pseudocumene,

toluene and dioxane. Safe, biodegradable cocktails are slow as those based on diisopropylnaphthalene (DIN).

– Spill-over of alphas and betas into each others' spectra is typically less than 0.2 % in 8 ml water:12 ml safe cocktail samples.

– Wallac PSA saves alpha and beta spectra. Automatic scanning can be carried out with a dedicated software package to test for the optimum division of events. Scanning can be made using any pure alpha and beta samples or by using a mixed alpha/beta and background sample.

Usage of Pulse Shape Analysis

PSA can be used for alpha/beta separation and extra background reduction in alpha and beta counting.

Most of the LSC background is composed of short pulses and thus fall into the beta spectrum while alpha background remains very small, typically much less than 0.1 CPM. One may therefore count natural decay series radionuclides with greater sensitivity by measuring their alpha emissions only than by counting the total alpha/beta activity. Another application is to count very small alpha activity in the presence of high beta activity: Wallac counters can detect less than 1 DPM of alpha activity in the presence of 100000 times more beta activity [12].

One may set the PSA to cut beta counting efficiency by 5 % for instance and a great reduction of beta background results particularly in glass vials, boosting already low background achieved by the active anticoincidence guard detector. In this software the PSA level can also be set based on the figure of merit.

Alpha background may be reduced analogously by cutting some alpha counting efficiency.

Advantages of Alpha Counting by LSC

- 1) 4π counting geometry (equivalent to geometrical factor = 1)
- 2) No sample self-absorption (as in the case of planchet counting)
- 3) Virtually 100 % counting efficiency (less than 50 % in planchet counting and solid state alpha spectrometry)
- 4) Simple sample preparation by mixing with a commercial cocktail

- 5) High throughput – automatic, multiple sample counting
- 6) Large sample capacity
- 7) Simultaneous alpha/beta counting (with separation of each spectrum using pulse shape analysis)
- 8) Low backgrounds and great sensitivity for alpha counting

Pulse Shape Analysis and Quench

Pulse length

Pulse length is a function of sample quench: The higher the quench, the shorter the pulse length. This is a physical phenomenon, not introduced by the instrument. When sample quench level is fairly consistent, there is no need to adjust the PSA level from sample to sample (the counting efficiency remains constant). If the quench variation is large (50 Ch or more), there may be need to readjust the level for variable quench or leave the PSA level to the optimum value for the lowest quench sample and let alpha efficiency drop at higher quench. Compensation for quench can be carried out by using a linear fit to efficiency vs. external quench parameter SQP(E) programmed as an output function.

Counting efficiency

Alpha particle counting efficiency remains close to 100 % up to very high quench levels, provided that the PSA level is set accordingly. This is due to the fact that the number of emitted photons per decay is several thousands and there is thus room for loss of photons and decay events are still observed. Alpha spectrum will shift to a lower channel at increasing quench and therefore counting window needs to cover the range of alpha channels under variable quench.

Energy resolution for alpha particles

Alpha energy resolution is about 300 keV FWHM at best in liquid scintillation counting (Fig. 4). The higher the sample quench, the poorer is the resolution. High quench, as in 8 ml water mixed with 12 ml cocktail, effectively merges the Ra-226, Rn-222 and Po-218 peaks into a single, broader one. The high energy Po-214 peak remains separated.

Resolution is also affected by the vial choice: translucent vials scatter light and offer better resolution (Teflon is the best), standard glass vials give poorer energy resolution [13].

During long storage of sample, deterioration of energy resolution may occur because of the accumulation of alpha emitters on the surface of vial. This leads to a smaller geometrical factor than unity for decays occurring on the surface. The alpha particles may also be partly absorbed in the wall. Poorer energy resolution and counting efficiency will result, alpha peaks creating a low energy tail. The aging effect can be avoided by adding acid, eg. HCl in 0.1 – 0.5 M concentrations.

Pulse Shape Analysis and plastic vial effect

Fast cocktails, as the ones containing toluene, xylene and pseudocumene will penetrate into the plastic vial wall resulting in deterioration of the alpha spectrum and instability of alpha count rate. Plastic vials are not recommended for counting using these cocktails, instead teflon coated plastic vials, glass vials or teflon vials should be used.

Identification of alpha emitters

Identification is always based on comparison with known samples. It is possible to create calibration curves for various alpha emitters by measuring the external standard quench parameter SQP(E) and emission peak position. Various alpha emitters will set on different calibration lines and can then be identified by measuring the quench parameter.

References:

- [1] Harrison, P., Rundt, K. and Oikari, T., Some Important Considerations when Evaluating LS Instrumentation, Wallac Oy, April 1990 (1200-971-01).
- [2] Rundt, K. and Kouru, H., Liquid Scintillation Counter for Measuring the Activity of Radioactive Samples Containing Multiple of Radioactive Isotopes. US Pat. 4,918,310, Apr. 7, 1990.
- [3] A New Dimension in Dual Label Counting, The Three Over Two Counting Method (document 1219-1000-01, April 1988) in 1214/1219 RackBeta Liquid Scintillation Counter Instrument Manual, Wallac Oy, February 1989.
- [4] Oikari, T. and Rundt, K., Method for Determining Counting Efficiency in a Liquid Scintillation Counting System. U.S. Patent No. 4,700,072, 1987.

[5] Rundt, K., Oikari, T. and Kouru, H., Quench Correction of Colored Samples in LSC, in Ross, H., Noakes, J.E. and Spaulding, J.D., eds., *Liquid Scintillation Counting and Organic Scintillators*, Lewis Publishers, 1991, pp. 677-689.

[6] Kouru, H. and Rundt, K., Multilabel Counting Using Digital Overlay Technique, in Ross, H., Noakes, J.E. and Spaulding, J.D., eds., *Liquid Scintillation Counting and Organic Scintillators*, Lewis Publishers, 1991, pp. 239-246.

[7] Kouru, Heikki, A New Quench Curve Fitting Procedure: Fine Tuning of a Spectrum Library, in Ross, H., Noakes, J.E. and Spaulding, J.D., eds., *Liquid Scintillation Counting and Organic Scintillators*, Lewis Publishers, 1991, pp. 247-255.

[8] Rundt, Kenneth, The Effect of Quench Curve Shape of the Solvent and Quencher in a Liquid Scintillation Counter, in Ross, H., Noakes, J.E. and Spaulding, J.D., eds., *Liquid Scintillation Counting and Organic Scintillators*, Lewis Publishers, 1991, pp. 257-268.

[9] Rundt, Kenneth, On the Determination and Compensation of Quench in Liquid Scintillation Counting, Ph.D. Thesis, Department of Physical Chemistry, Åbo Akademi, Finland 1989, 134 p.

[10] Rundt, Kenneth, Digital Overlay Technique in Liquid-Scintillation Counting – A Review. *Radioactivity & Radiochemistry*, p. 14-25, 3(1) 1992.

[11] Oikari, T., Kojola, H., Nurmi, J. and Kaihola, L., Simultaneous counting of low alpha- and beta-particle activities with liquid-scintillation spectrometry and pulse-shape analysis. *Int. J. Appl. Radiat. Isot.* 38, 875 (1987).

[12] Kaihola, L., Oikari, T. and Suontausta, J., Ultra sensitive alpha particle detection in the presence of high beta activity by low level liquid scintillation spectrometry. *Int. Conf. on Advances in Liquid Scintillation Spectrometry, LSC94*, Glasgow, Scotland, Aug 8-12, 1994.

[13] Product News Letter: Pulse Shape Analysis, Wallac Oy, February 1987, November 1991.

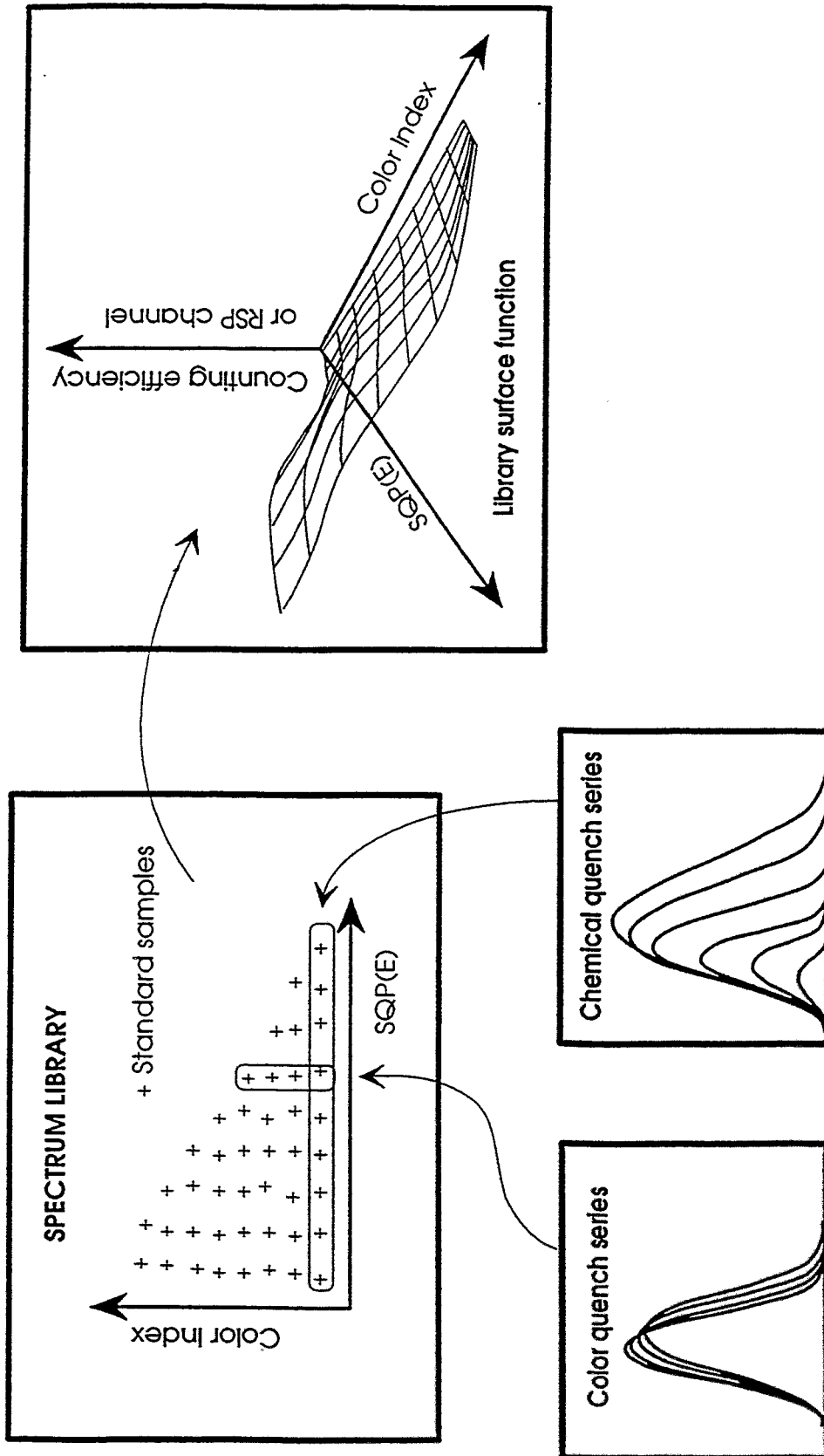

Fig. 1. Counting efficiency surface in DOT as a function of chemical and color quench indices.

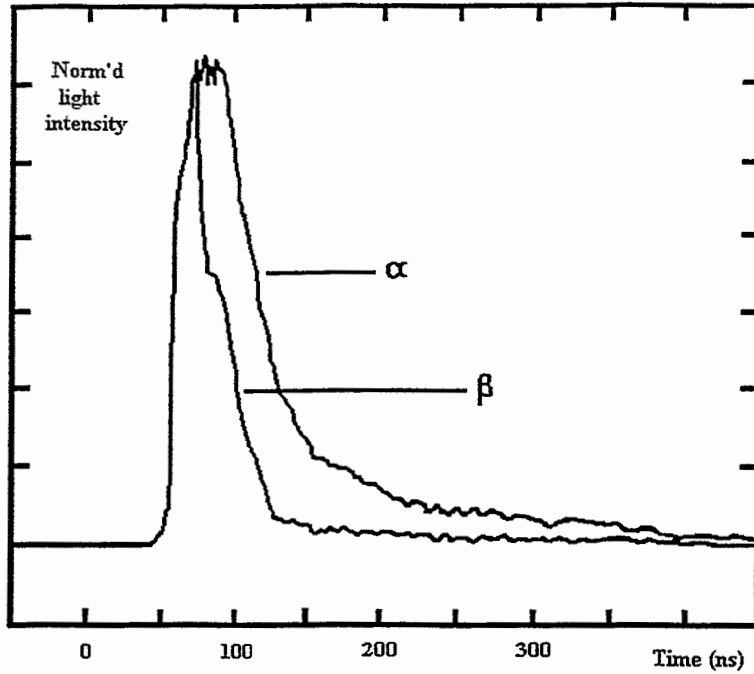

Fig. 2. Pulse shape for events caused by beta and alpha particles.

Pulse length vs. pulse height for Ra-226 by Quantulus

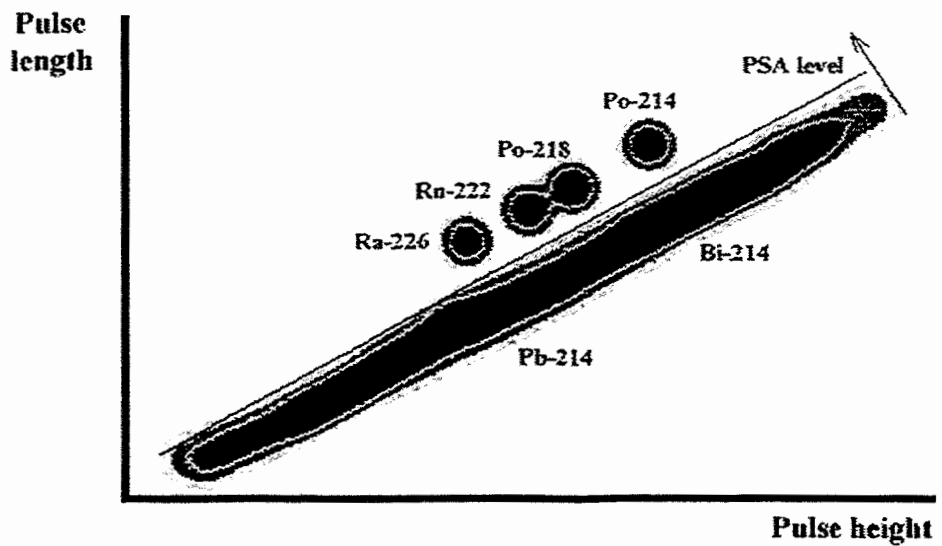
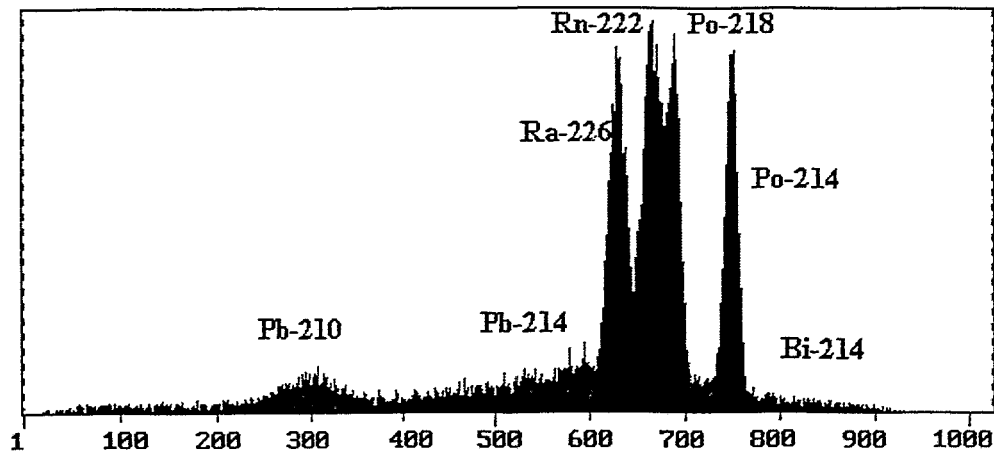

Fig. 3. 3-D spectrum of Ra-226 vs. pulse amplitude (total signal) and pulse length (tail signal).



Ra-226 alpha and beta particle spectra by Wallac Pulse Shape Analyzer

Vial: Copper-teflon 15 ml

Sample: 1 ml water / 9 ml Optiphase HiSafe 3

Fig. 4. Alpha and beta particle spectrum of Ra-226 measured in a Wallac liquid scintillation counter.

LOW-LEVEL LIQUID SZINTILLATION COUNTING FOR QUANTIFICATION OF ANNUAL ^3H AND ^{14}C CONCENTRATIONS IN TREE DISKS

B. Kopka, J. Schikowski, J. Porstendörfer

Isotopenlaboratorium für biologische und medizinische Forschung
der Georg-August-Universität Göttingen
Burckhardtweg 2, D-37077 Göttingen

1 Introduction

The government of Schleswig Holstein funded a study to perform the retrospective determination of airborne ^3H and ^{14}C concentrations. It is well known, that in tree rings most of the hydrogen and carbon is fixed after insertion in the matrix of wood and that the radionuclide concentration correlates with former airborne activity concentrations [1, 2].

For the retrospective study wood disks of trees located in the region near the nuclear power plant of Krümmel and control disks of unsuspected areas were selected. At the Isotopenlaboratorium of the University of Göttingen tree rings of three oak trees and three pine trees were analysed.

The hydrogen of the wood was transformed to water and the carbon to carbondioxide by classical oxidation processes (combustion in a furnace) [3, 4]. The contents of ^3H in the water and ^{14}C of the carbondioxide (solved in scintillation liquid) were determined by liquid scintillation counting, using a low-level counter (type Quantulus 1220, Wallac).

2 Sample Preparation

We separated the tree disks with a chisel into their annual rings and grinded the wood to particles less then 2 mm height. Each sample had a weight of 20 g. The samples were burned with a self made 2 zone furnace (Fig.1). After the oxidation we collected the water in two water traps, the first filled with ice and the second with dry ice plus methanol. The CO_2 was absorbed in sodium hydroxide. The furnace temperature and the flow of oxygen and nitrogen were computer controlled. The combustion of 20 g wood, yield between 8.9 ml and 10.2 ml water, corresponding to an output of 83 % to 95 %. For CO_2 we find a quantity of 100 %.

The sodium carbonate was transmited to a carbamate, filled up with Omniszintisol and measured as a liquid scintillation sample. With this simple technique 0.49 g of carbon could be measured in one sample.

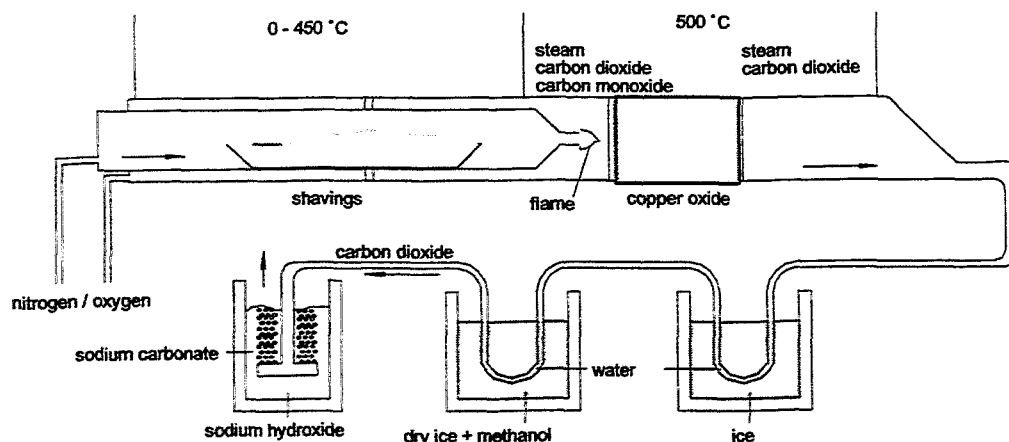

Fig. 1 Combustion furnace

3 Measuring Method

3.1 Counter

For the measurement a low-level counter from Wallac (Turku, Finland), type Quantulus was used. This counter has a very large passive shield of lead at least 10 cm and 17 cm above the measurement chamber to decrease the background. Furthermore there is an active shielding system with two guard photomultiplier tubes. Samples are moved up into the measurement chamber, so the shield against cosmic radiation is not interrupted. A electronic background reduction is used (Fig. 2). The Quantulus software is able to do multichannel analysing and under the aspect of optimum results to calculate the figure of merit (FOM).

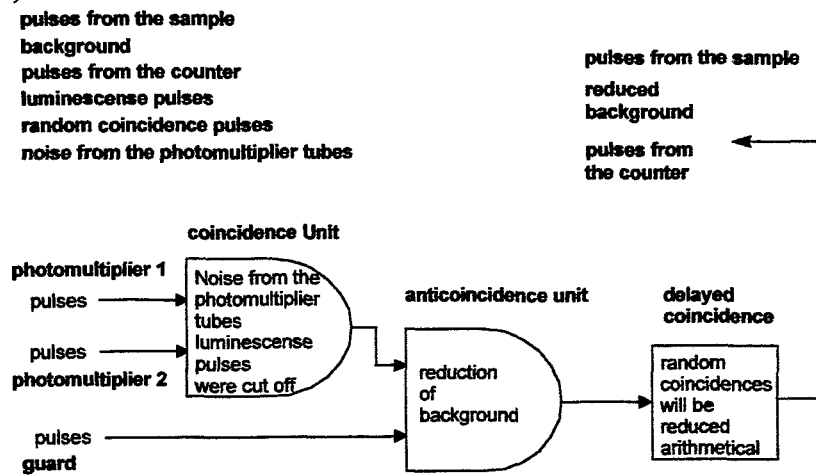

Fig. 2 Electronic background reduction of the Quantulus

3.2 Choice of Cocktail and Vial

Several safe cocktails with high water take up were tested: Ultima-Gold XR, Hi-Safe 3 and Quicksafe 400. For the test measurements poly- and teflon-vials were used. All materials were selected according to long time stability and FOM factor.

The FOM factor is a quality factor for the measurement expressed by:

$$FOM = \frac{\eta [\%]^2}{n_0 [cpm]} \quad \eta = \text{efficiency} \quad n_0 = \text{background}$$

For the determination of ^3H poly-vials were used. Teflon-vials yield a small increase of efficiency but the price was too high. For ^{14}C measurements a reduction of the reading of less then 10 % after 3 month was found with poly-vials, and no reduction with teflon-vials. This is an effect of the higher vapour permeability of the poly-vials.

3.3 ^3H Measurement

For examination of background low-level water from the Bundesanstalt für Gewässerkunde ($T_0 < 0.025 \text{ Bq/l}$) was used. As standard well calibrated water from former init comparison campaign „ ^3H in water“ from 1991 ($T_3 = 100.1 \text{ Bq/l}$ on 03.01.1993) was used. After these calibrations and test measurements 9 ml of sample water from the combustion were mixed with 11 ml Hi-Safe3 cocktail. A background of 0.53 cpm yield a theoretical detection limit of 1 Bq/kg in wood. The over all error is 0.9 Bq/kg in wood.

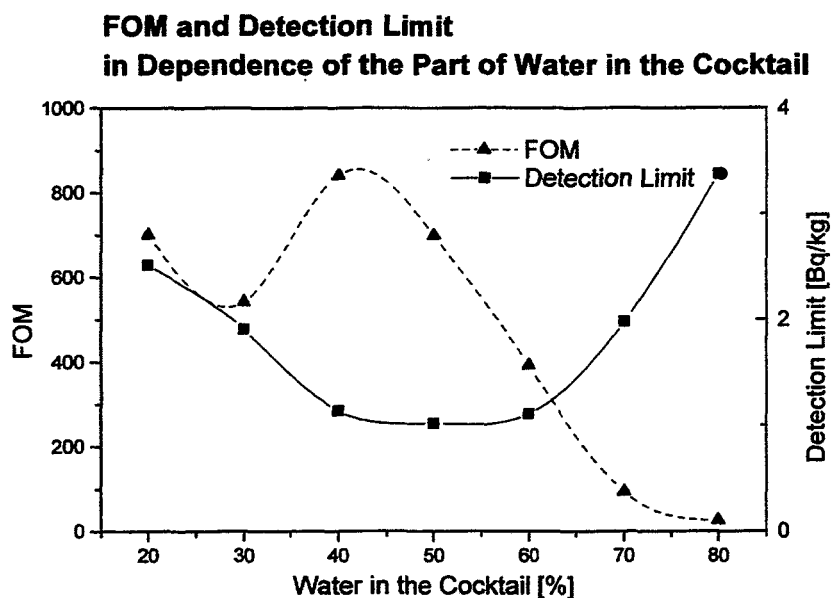

Fig. 3 FOM and detection limit

3.5 ¹⁴C Measurement

For CO₂ absorbing 2-Methoxyethylamin was used. The corresponding carbamat was mixed with Omnizintisol. The combustion yield 10 g of carbon. For activity measurements two samples of 0.49 g carbon were measured 3 times 240 min. To get background samples for the ¹⁴C measurement we used CO₂ from a gas cylinder and BaCO₃ produced by Merck. The average value for ¹⁴C background was 2.28 cpm, equal to 112 Bq/kg carbon. The detection limit is 11.1 Bq/kg wood. The analytical error was determined by combustion of 6 sample of the same tree ring. It is negligible compared to the statistical error.

4 Results

In Fig. 4 and Fig. 5 some results of the tree disk measurements are shown. Higher concentrations of ³H and ¹⁴C in the environment in the years 1957 to 1965 are results of several atomic bomb explosions in the atmosphere. The measurement of annual tree rings can be used to reflect the environmental concentrations of ³H and ¹⁴C. For ¹⁴C it can be assumed that the concentration in the tree ring is equal to the mean concentration in the atmosphere of the examined year. Looking to ³H, we have to notice, that the results must be corrected because the half life is about 12 years and measurement results are nearby the detection limit. The elevated analytical error may be explained with working in an radionuclide laboratory with ³H inventory.

Any accident in a nuclear power plant with high output of radioactive isotopes, specially ³H and ¹⁴C, is not reflected in that figures. As shown in Fig. 5, the results from the oak trees are close together, though they are from 3 positions in Niedersachsen and Schleswig Holstein.

Before the shavings were burned, they were put on a gamma detector to look for other radionuclides from the atomic bomb fallout (e.g. ¹³⁷Cs), but they could not be detected.

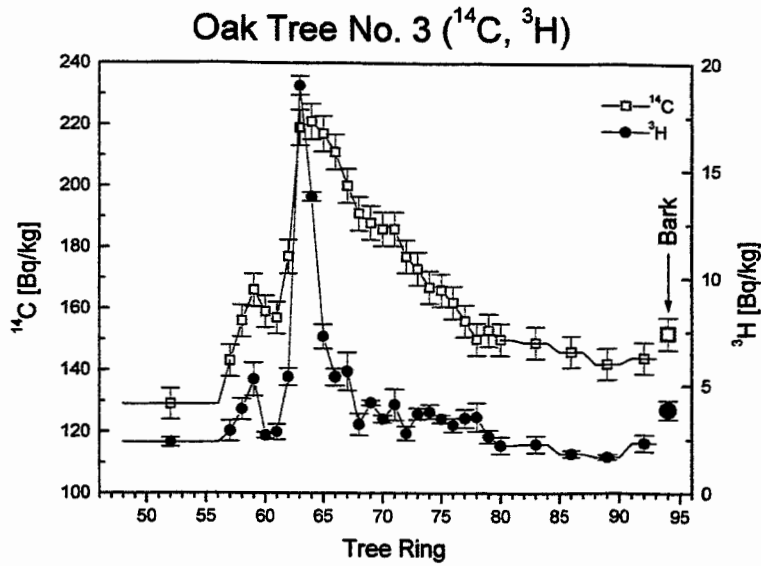

Fig. 4: ^3H - and ^{14}C -Measurement results of oak tree No. 3

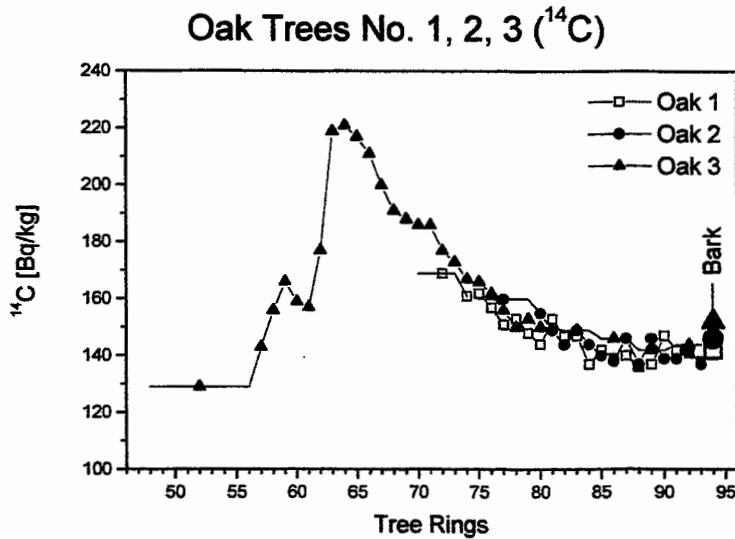

Fig. 5: ^{14}C -Measurement results of all oak trees

References

- [1] **K. Kozak, B. Obelic, N. Horvatincic** "Tritium and ^{14}C in tree rings of the last three decades", *Radiocarbon*, **13**, 766-770, 1989
- [2] **G. Wallner** "Determination of environmental tritium in tree rings", *Liquid Scintillation Spectrometry 1992*, edited by J.E. Noakes, F. Schönhofer and H.A. Polach, *Radiocarbon* 349-353, 1993
- [3] **S. Hisamatsu, T. Hashimoto, Y. Takizawa** "Tritium concentration in some european foods", *J. Radioanal. Nucl. Chem., Letters* **146**, 245-253, 1990
- [4] **M.J. Wood, R.G.C. McElroy, R.A. Surette, R.M. Brown** "Tritium sampling and measurement", *Health Physics* **65**, 610-627, 1993

Practical Aspects of Tritium Measurement in Ground and Surface Waters

O.Nitzsche & D.Hebert

Institut für Angewandte Physik
Technische Universität Bergakademie Freiberg
B.-von-Cotta-Str. 4
e-mail: nitzsche@physik.tu-freiberg.de

Summary

Tritium measurements are a powerful tool in hydrological and hydrogeological investigations for detecting mean residence times of several water reservoirs. Due to the low tritium activities in precipitation, ground and surface waters a low level measurement is necessary. Therefore often the liquid scintillation counting after an electrolytic enrichment of water is used. In this paper some practical aspects and problems of measurement are discussed and the problem of contamination in low level laboratories is shown.

Introduction

Tritium- ^3H - is a radioactive isotope with β^- decay of a half-life of 12.43 a and a maximum β^- energy of 18.6 keV. The main sources of tritium in the environment are cosmic ray produced tritium by spallation reactions and the tritium fallout from thermonuclear weapon tests in the atmosphere in the past. Sources of local importance are nuclear industries or the watch industry using tritium β^- radiation for luminescence effects. Tritium will be oxidized to HTO and so it becomes a part of the natural water circle.

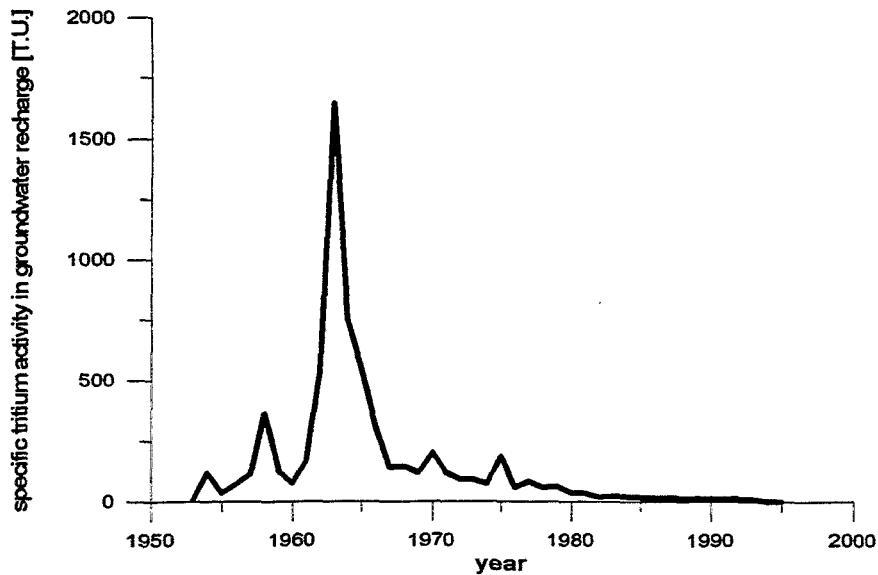

fig.1 tritium input function from station Freiberg

Since 1961, more than 100 stations in 65 countries have been collected monthly precipitation samples for the IAEA Isotopes-in-Precipitation Network (IAEA TECHNICAL REPORT SERIES). Except ^3H also ^2H and ^{18}O is measured. Singular stations have been measured even more in the past. From this values tritium in precipitation input functions for several places can be calculated. Missing data's can be fitted by correlation's including lateral and continental transport effects (HEBERT, 1990). The tritium input function for groundwater recharge from Freiberg is shown in fig. 1 (1 T.U. \equiv 1 ^3H atom per 10^{18} H atoms \approx 0.118 Bq/l water)

The activity during tritium fallout is more than 2 magnitudes higher than the level caused by cosmic rays. It is also shown, that tritium activities in environmental waters are very low.

Tritium Measurement in the Environment

In fig.2 the range of tritium activities in natural waters are shown. The magnitude can be compared with the official safety limit for handling tritium (in 1 l water).

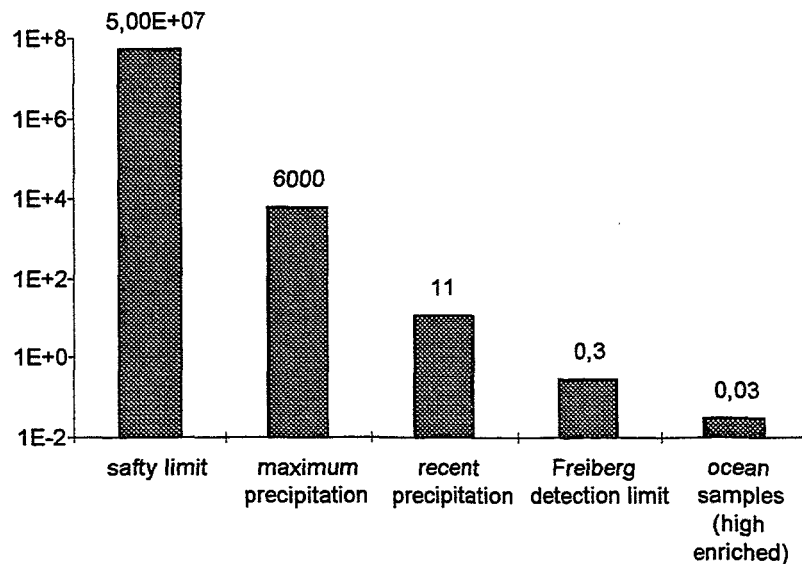

fig.2 Range of tritium activities in natural waters in comparison with safety limit

In Freiberg, the measurement of such low β^- activities can be done by a two step process. The first step is an electrolytic enrichment of 250 ml water. The second step is β^- counting of the resulting 8 ml water. Therefore liquid scintillation counting is used with the Quantulus 1220 (WALLAC GmbH). For a low detection limit a high enrichment factor and a low counting background is necessary. The parameters in Freiberg laboratory are:

enrichment factor:	16-18
background (usually):	1.0 cpm
background (special vials)	0.6 cpm
counting efficiency:	25 %
sample volume	8 ml

In fig. 3 the detection limit as function of enrichment factor and background is shown. In the case of high enrichment the influence of background becomes smaller. However, in the case of measuring samples of small amount, where no enrichment is possible the background is the most important parameter. Decreasing activities in natural waters will be detectable in future only by increasing the enrichment factor and decreasing the background.

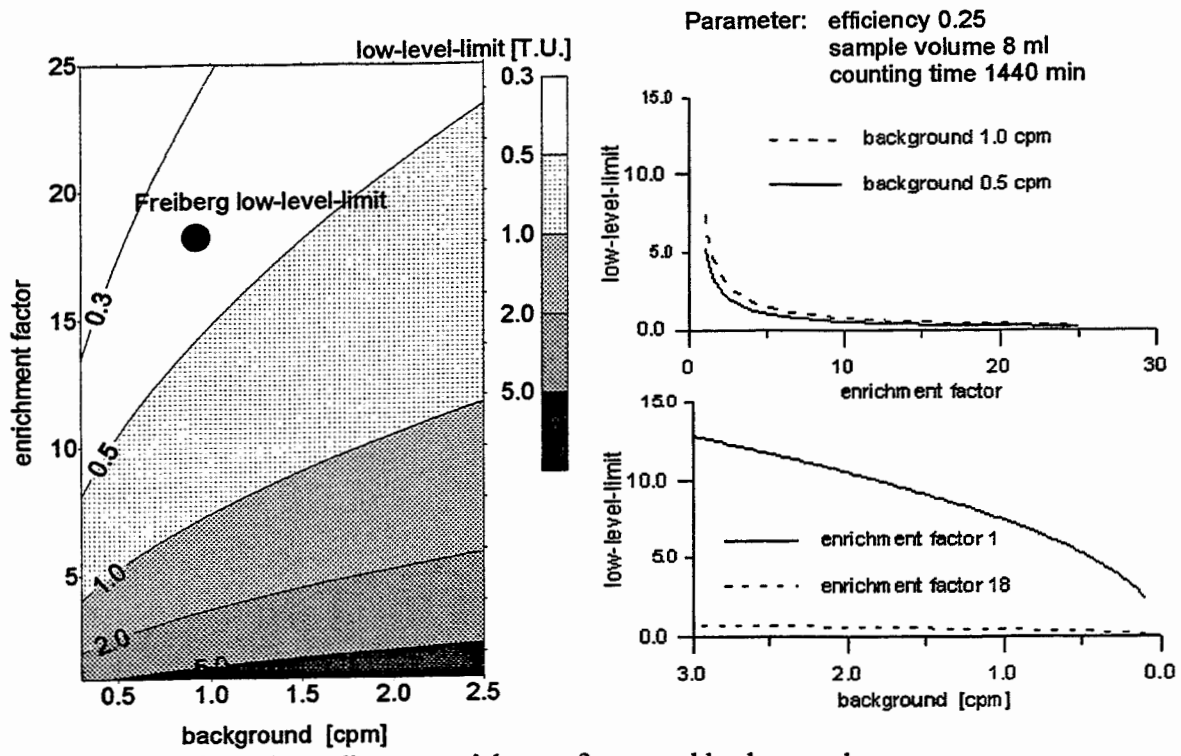

fig.3 detection limit depending on enrichment factor and background

Problems with Contamination

Due to the very low activities in the samples, contamination in the air moisture in laboratory can have a great influence. Sometimes results can not be used. Sources of contamination are direct tritium sources or generators of fast neutrons. The resulting HTO will be very fast mixed with the water in the surrounding air.

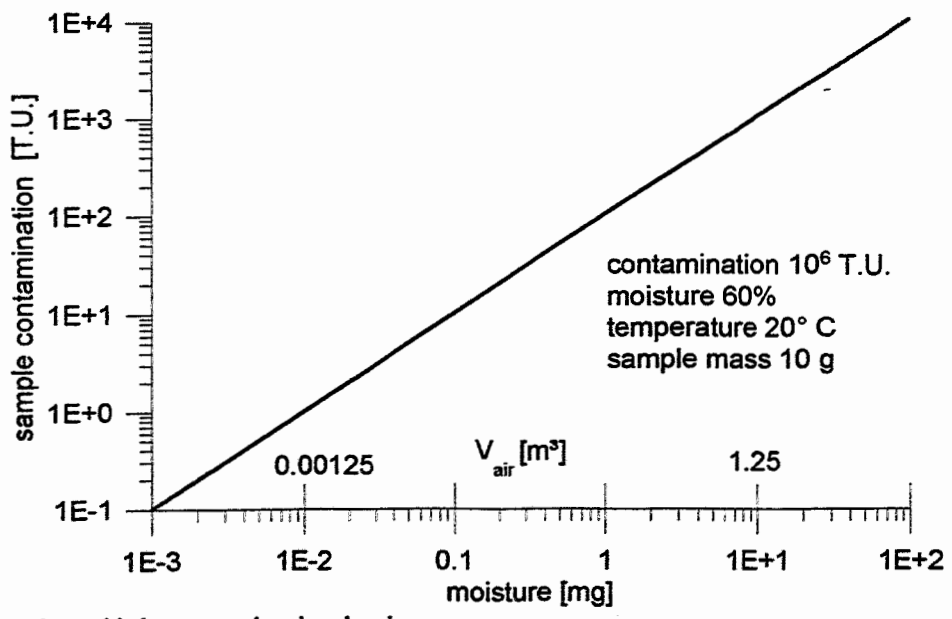

fig.4 effect for a high contamination in air

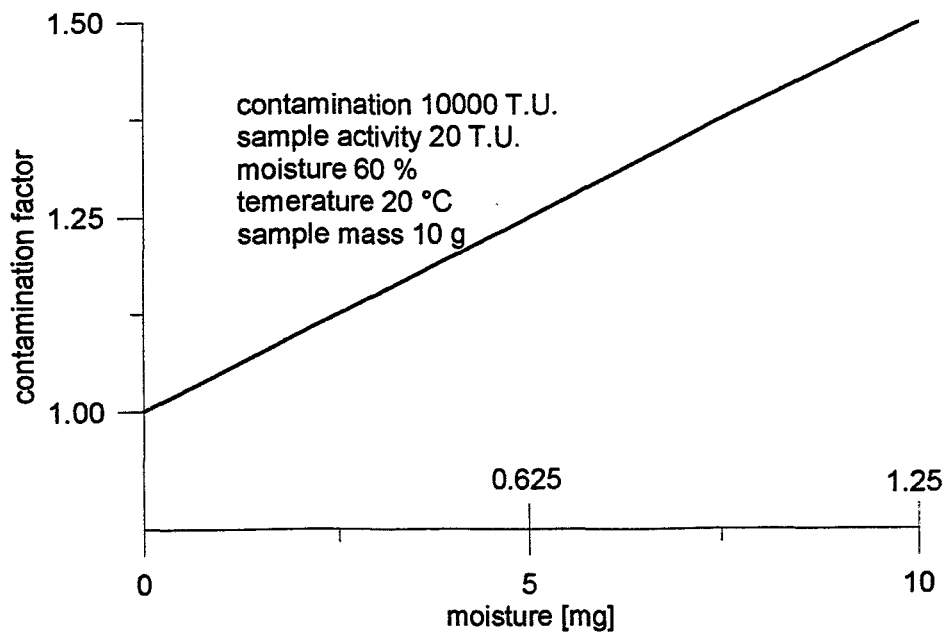

fig. 5 effect for a low contamination in air

Tritium contamination can be transported with moisture in air over a long distance (LEWIS, 1984) or by moisture in breath of contaminated persons. Also plastic watches with tritium for luminescence effects can be sources of contamination due to diffusion of tritium.

References

HEBERT. D., *"Tritium in der Atmosphäre"*, Freiburger Forschungsheft C443, Deutscher Verlag für Grundstoffindustrie, Leipzig, 1990

IAEA, Environmental Isotopes Data No. 1-10, Technical Reports Series No 96, 117, 129, 147, 165, 192, 226, 264, 311, 371, IAEA, Vienna, 1969-1994

LEWIS, R., *"Beiträge zur Untersuchung und Nutzung von atmosphärischem Tritium"*, Dissertation, Bergakademie Freiberg, 1984

**RADIOCHEMICAL TRACE ANALYSIS METHODS:
DEVELOPMENT AND APPLICATION OF A FAST AND VERY SENSITIVE
PROCEDURE TO DETERMINE LONG-LIVING NEUTRON ACTIVATION
PRODUCTS**

R. Schupfner, W. König, Ch. Scheuerer, H. Schüttelkopf

Environmental Radioactivity Laboratory, University of Regensburg,
93040 Regensburg, Germany

From all radioactive elements which were determined during the past decades the long-living neutron activation products mainly Fe-55 (half life: 2,7 y [1]) and Ni-63 (half life: 96 y [1]) and Ni-59 (half life: 75000 y [1]) demand increasing attention. In the near future many of the over 400 nuclear power plants worldwide which are mainly situated in highly industrialized regions have to be decommissioned. Only few years after the final shutdown the determination of the activities of Fe-55, Ni-63, Ni-59 in various sample materials for the purpose of monitoring incorporated radionuclides or nuclear waste declaration gain significance. In present decommissioning projects (e.g. KRB A, Gundremmingen, Germany) these radionuclides are going to replace Co-60 as leading nuclide under certain conditions. There are many devices in a nuclear power plant such as biological shielding or reactor pressure vessel or installations of the reactor core which consist of stable iron and nickel as major element and which are exposed to a high neutron flux over up to several decades. Corrosion processes and the transport via primary water are responsible for contamination of not directly activated installations as for example the recirculating loop or the piping of the secondary steam generators. In all cases Fe-55 and Ni-63 are one of the radionuclides with the highest activity concentrations within a few years after the final shutdown. There is a not diminishing risk for the reactor decommissioning personnel of incorporating these radionuclides via inhalation. Although Fe-55, Ni-63, Ni-59 [3, 4] do not contribute to the total effective dose equivalent to the same degree as the actinides Am-241, Cm-244, Pu-239/240, Pu-238, Pu-241 those radionuclides are able to fulfill an important role as monitor for the purpose of assessing the incorporation of actinides whose determination via direct methods or analyses of excreta is very difficult and combined with a considerable extent of time and manpower. Analyses of Fe-55 and Ni-63/59 in excreta, modelling of there excretion behavior in man and nevertheless the well known ratios of the activity concentrations of all radionuclides of interest allow a more sensitive assessment of incorporated actinides with much less extent of time and manpower.

Unfortunate direct methods of determining Fe-55 [5, 6] and Ni-63/59 [6] are not suitable because of the disadvantageous decay properties [1] of the above radionuclides. The determination methods which were published up to the early nineties are either fast but less sensitive or more sensitive but rather slow and time consuming. In addition to this the older methods are not able to handle amounts of stable iron of over a few tenth of mg. At the same time the requirement to the determination methods are increasing rapidly in both aspects quality and quantity. Therefore a determination method has been developed combining high sensitivity and high reliability with fast analysis procedure [7, 8].

Besides human excreta the analytical procedure must be applicable to a variety of sample materials such as steel, alloys, corrosion products, concrete, organic chemical compounds, glass fibers, soil and many more. Before measurement a radiochemical purification procedure of Fe-55, Ni-63/59 is necessary to reach very small detection limits (in the present paper calculated according to KTA-rules with a confidence level of 99,7 %) [9]. For this

purpose Fe-55, Ni-63/59 must be completely dissolved which requires special desintegration procedures for every sample material.

The first purification step is a preconcentration of Fe-55 or Ni-63/59 respectively using the chelating resin column CHELEX 100 [10]. This chelating resin is composed of a styrene-divinyl-benzene polymer as a carrier of the iminoacetic groups. In the past CHELEX 100 has been used for preconcentrating heavy metal ions in sea water or spring water. At low pH values this chelating resin is able to preconcentrate Fe-55 or Ni-63/59 respectively [7, 8]. Undesireable ions from the sample material e. g. Na^+ , K^+ , Mg^{2+} , Ca^{2+} , SiO_4^{2-} , SO_4^{2-} , PO_4^{3-} are completely removed. Because of its not jet sufficient selectivity various highly selective and fast purification steps including anion exchange to separate Co-60 [11] and liquid-liquid extraction with diisopropylether for Fe-55 [5, 8] and chloroform for Ni-63/59 [7] are applied to obtain a diluted sulfuric acid solution which can be mixed with a suitable scintillation cocktail and measured by means of liquid scintillation counting (LSC).

The values of the chemical yields prove to be $(92 \pm 3) \%$ for Fe-55 and $(95 \pm 5) \%$ for Ni-63/59 in any sample material. The decontamination factors describing the selectivity of the analysis procedure have been determined for all important interfering artificially and naturally occurring radionuclides ranging from over 10^5 to 10^9 in the case of Fe-55 (except Sb with $2 \cdot 10^3$) and about 10^4 to 10^{11} in the case of Ni-63/59 [7, 8].

To correct individual losses of chemical yield stable iron and nickel as chemical yield tracers are determined by means of atomic absorption spectroscopy or optical absorption measurements.

The most suitable counting technique for determining the low energy emitters Fe-55, Ni-63, Ni-59 are LSC-techniques. The counting of the sample solutions prepared for measurement can be started after a cooling time of 30 to 60 minutes in an anticoincidence shielded liquid scintillation counter LSC Quantulus 1220 (LKB Wallac). Its effective passive and active shielding devices suppress the natural background counting rate to a value of about 1,5 cpm (counts per minute) for Fe-55 and 2,1 lpm for Ni-63/59. The counting efficiencies at a volume ratio of 15 ml scintillation cocktail (here: QUICKSZINT 400) to 5 ml sample solution are a function of the content of stable iron or nickel respectively. At low iron or nickel contents of about 1 mg or less the counting efficiencies are about 0,27 cps/Bq for Fe-55 and 0,62 cps/Bq for Ni-63/59. At a counting time of 1000 minutes the detection limits reach values of 0,012 Bq Fe-55 per sample and 0,003 Bq Ni-63/59 per sample.

Above 0,15 g iron and 0,04 g nickel can be analysed without notable losses in chemical yield. Sample amounts of up to 2 L of urine, 500 g of faeces, 0,4 g of steel, 5 g of concrete and 6 g of soil were analysed with values for the detection limits of activity concentration as follows:

0,006 Bq Fe-55 per L urine, 0,003 Bq Ni-63/59 per L urine,
0,024 Bq Fe-55 per kg faeces, 0,01 Bq Ni-63/59 per kg faeces,
0,028 Bq Fe-55 per g steel, 0,015 Bq Ni-63/59 per g steel,
0,002 Bq Fe-55 per g concrete, 0,001 Bq Ni-63/59 per g concrete.

Up to eight analyses can be performed by one person within eight hours. There is no possibility to separate the peak of the decay of Ni-63 from Ni-59 with the LSC techniques other techniques are to be employed for a specific determination of Ni-59.

An application of the analysis of Fe-55 with this method is to assess the inhalation of actinides from the data of Fe-55 in urine. Under the conditions of the limits of intake of radionuclides by occupational exposed persons of category A which has been established in the

Federal Republic of Germany the detection limit for the determination of incorporated radionuclides must enable the assessment of the committed dose equivalent (50 years) of the critical organ or tissue (bone surface for the interesting alpha emitting nuclides) which are not allowed to exceed a value of 9 mSv per year [12]. Applying the kinetic model of Thind [13] to assess the iron excretion via urine after inhalation of ironoxide it is possible to determine the detection limit of incorporated Fe-55 as 30 Bq per day. This value is significantly below the demanded value of 50 Bq per day [14].

If the complete nuclide vector (defined as the ratios of activity concentrations of all known radionuclides to a leading radionuclide) including the actinides is known the inhaled amount of Am-241, Cm-244, Pu-239/240, Pu-238, Pu-241 can be calculated. This is to be pointed out here with the data from the decommissioning project of KRB A, Gundremmingen, Germany. As nuclide vectors the mean values of all three secondary steam generators has been used. Even eight years after the final shutdown the reachable detection limit for Fe-55 enables the determination of about 4 to 5 Bq of inhaled alpha emitting nuclides (König [5]). In other nuclear power plants (Robertson [15] and in other devices of KRB A like the reactor pressure vessel the suitable period of time using Fe-55 as leading radionuclide for purposes of incorporation monitoring range from 10 to up to 30 years and even more.

If the activity concentration of Fe-55 exceeds that of the alpha emitting radionuclides about an factor of six at any time the Fe-55 can be used as monitoring nuclide employing the analytical procedure described here.

Acknowledgement

Financial support from the Bayerisches Staatsministerium für Landesentwicklung und Umweltfragen is gratefully be acknowledged.

The authors wish to thank Dr. Steiner from KRB A, Gundremmingen, Germany for making available the data and samples from KRB A.

References

- [1] ICRP Publication 38,
Radionuclide Transformations,
Pergamon Press, Oxford, New York, Frankfurt, Volumes 11-13, 1983.
- [3] Lieser, K. H.,
Einführung in die Kernchemie, 2. Auflage, Verlag Chemie, Weinheim, 1980.
- [4] Noske, D., Gerich, B., Langner S.,
Dosisfaktoren für Inhalation oder Ingestion von Radionuklidverbindungen ^
(Erwachsene),
ISH-Bericht 63/85, Institut für Strahlenhygiene des Bundesgesundheitsamtes, 1985.

- [5] König, W.,
Thesis,
University of Regensburg, 1996.
- [6] Schupfner, R.,
Schlußbericht zum Projekt:
„Entwicklung von Analysen- und Meßmethoden für die Nuklide Ni-63, Ni-59, Fe-55
und Np-237“
für das Bayerische Staatsministerium für Landesentwicklung und Umweltfragen., 1994.
- [7] Scheuerer, Ch., Schupfner, R., Schüttelkopf, H.,
Journal of Radioanalytical und Nuclear Chemistry, Vol. 193, No.1, 126-132, 1995.
- [8] König, W., Schupfner, R., Schüttelkopf, H.,
Journal of Radioanalytical und Nuclear Chemistry, Vol. 193, No.1, 119-125, 1995.
- [9] DIN 25482 Teil 1,
Nachweisgrenze und Erkennungsgrenze
bei Kernstrahlungsmessungen,
Beuth Verlag, April 1989.
- [10] Bio-Rad Laboratories,
Instruction Manual,
Chelex 100 Chelating Ion Resin,
Richmond, U.S.A., 1993.
- [11] Korkisch, J.,
Handbook of Ion Exchange Resins, CRC Press, Florida, Volume 5, 119-133, 1989.
- [12] Strahlenschutzverordnung, 1989.
- [13] Thind, K. S.,
Health Physics 68,9, 1995.
- [14] Richtlinie für die physikalische Strahlenschutzkontrolle (§62 und § 63),
Gemeins. RdSchr. d. BMU - RS II3A -15530/1- u. d. BMA -VIIIb6-35733-
v. 20. Dezember 1993 (GMBI. 1994 S286).
- [15] Robertson et al.,
Radioactive Waste Management and the
Reactor Fuel Cycle Vol. 5(4), 302, 1984.

VI. Application of Gammaspectrometric Low-Level Measuring Techniques

Chairperson: A. Andràsi

Neutron Activation Analysis of Low-Level Elemental Contents in Silicon Wafers

W. Görner^a, A. Berger^a, S. Niese^b, M. Köhler^b, M. Matthes^c, D. Gawlik^d

a Bundesanstalt für Materialforschung und -prüfung, Berlin, Germany

b Verein für Kernverfahrenstechnik und Analytik Rossendorf e.V., Germany

c on leave from Hahn-Meitner-Institut, Berlin, Germany

d Hahn-Meitner-Institut, Berlin, Germany

Semiconductor silicon is among the purest materials having ever been produced by modern technology. Thus, it is quite suitable as a primary reference material validating the correctness and the detection capabilities of developed analytical methods. Among them neutron activation analysis plays a competitive role (see refs. 1 to 3). The U.S. National Institute of Science and Technology (NIST) had initiated and carried out an interlaboratory comparison in order to study the spread of analytical results worldwide evolved by several laboratories dealing with specimens of extreme purity. The outcome of the experiment was intended to review the capabilities of NAA as well as to differentiate between bulk and surface contamination (see ref 4).

Experimental

Two silicon wafer types donated by Eastman Kodak Co. were distributed by the National Institute of Science and Technology (NIST). Each wafer was 10 cm in diameter and 524 μm thick, one wafer offering "moderate purity", the other one "high purity".

Our first attempt to analyse the silicon so as to elemental levels and their spatial distribution suffered from tremendous contamination (in the ng/g-scale) and consequently from varying contents from subsample to subsample. This disappointing result was due to the lack of long-term experience of the collaborating parties in the field of semiconductor silicon analysis.

In a second run several subsamples originally located near the edge of the wafers and having been left aside during the first trial were carefully packed and treated. Irradiation of samples and multielemental standards took place in the core of the Hahn-Meitner-Institute research reactor (BER II). The thermal neutron dose was $5 \cdot 10^{19} \text{ cm}^{-2}$. After the irradiation the subsamples were treated stepwise by rather soft etching at room temperature:

- 1 10 s with HF 40%
- 2 300 s with HF 40%
- 3 10 s with HF 40 % + inactive carrier solution
- 4 10 s with HF 40% + HNO₃ 60%.

Counting (7200 s to 20000 s) was carried out with a HPGe well detector with a relative efficiency of 10% and FWHM = 2.2 keV at $E_{\gamma} = 1332 \text{ keV}$.

10 subsamples were taken for a comparative measurement in the FELSENKELLER underground laboratory (see loc. cit. of these proceedings). In a few selected cases counting intervals mounted up to 250000 s, whereas most measurements had a duration of 20000 s to 50000 s.

Results

Fig. 1 shows the decrease of gold and zinc contents with consecutive etching. Obviously, the applied etching procedure is too soft to diminish the surface gold content at ppt-level, whereas sub-ppb gold levels as well as ppb zinc levels could be significantly reduced. As a whole, taking all elements determined into consideration wafer 2 has the higher trace concentrations and we don't believe that this fact may be explained by contamination, as the subsamples of the two wafers have been treated individually in parallel.

Table 1 compiles the ranges of contents of elements determined in comparison with results obtained by 9 international laboratories within the NIST round robin test (values in the upper line: wafer 1, lower line: wafer 2). At a glance it is to be seen that the analysis at the sub-ng/g-level is rather problematic and suspicious to contamination. The authors of ref. 4 argued in the case of gold, that their results may be plausible, when bulk contents of down to 10^{-4} ng/g and surface contents of up to 10^{-1} ng/g may be assumed. Our results do not contradict this assumption.

In order to discuss the benefit of the FELSENKELLER laboratory, fig. 2a displays the background spectra taken in a surface laboratory and in the underground laboratory together with the ultra-low content of subsample no. 668 (wafer 1). For "zero activity" samples the limit of detection may be decreased by a factor of 5. But this is only true, if the total activity of the sample does not significantly exceed 0.1 Bq. In the spectrum of the subsample no. 675 (wafer 2) ^{60}Co is dominating to such an extent (see fig. 2b) that counting in the underground laboratory is not beneficial.

The direct comparison of some results obtained in Berlin and Dresden generally shows satisfying agreement. A few exceptions have to be discussed. The smaller values for cobalt obtained in the FELSENKELLER are due to the lower standard deviation (lower background, longer counting intervals) especially in the high energy region, which is also true for the low scandium content samples, whereas the scandium values at pg/g-level show good agreement. The solitary discrepancy between the selenium values of sample no. 668 and 669 might result from spurious contamination with selenium as the Hahn-Meitner-Group is engaged in biological and medical selenium research.

Conclusion

High flux neutron activation analysis is a suitable method determining a broad scale of elemental traces (sub-ng/g range) in semiconductor silicon after etching but without chemical separation. Low active samples are favourably counted in the FELSENKELLER underground laboratory when their effective high energy component of the activity does not exceed the level of 0.1 Bq by far.

Zinc content [ppb]

Sample	1	2	3	4
673	0,51	0,40	0,25	0,23
674	0,78	0,55	0,77	0,35
675	2,11	0,87	0,71	0,51
676	2,00	0,87	0,58	0,50
677	1,06	0,84	0,62	0,58

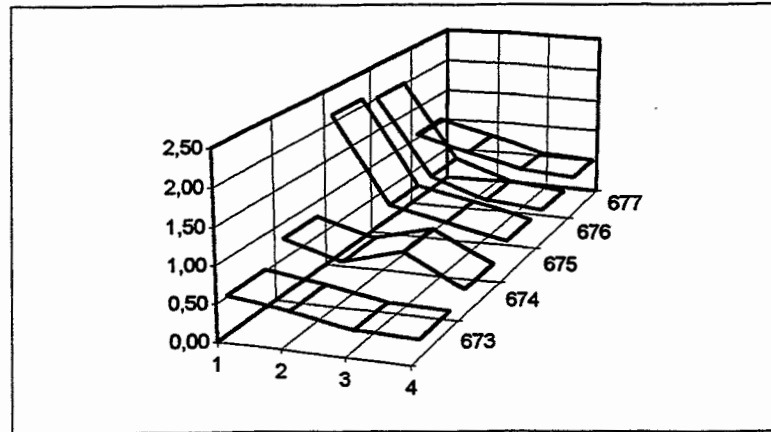

Gold content [ppb]

Sample	1	2	3	4
673	0,006	0,004	0,004	0,004
677	0,006	0,006	0,011	0,007
674	0,098	0,094	0,095	0,084
676	0,105	0,100	0,097	0,089
675	0,277	0,248	0,118	0,156

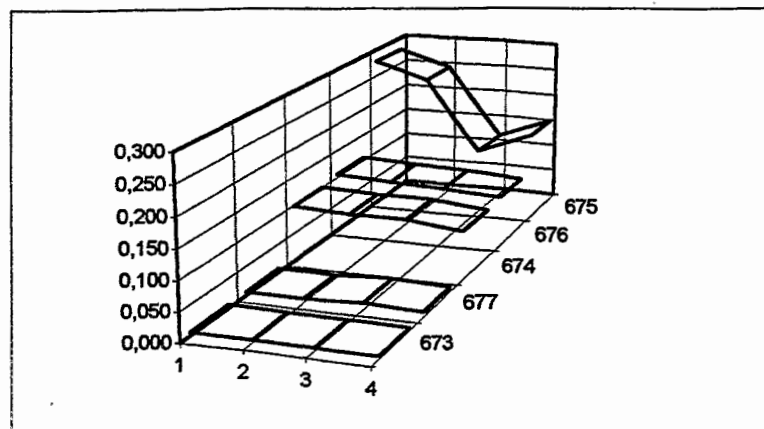

Fig. 1 Decrease of gold and Zinc with consecutive etching

Element	9 international laboratories		this work
		(after heavy etching)	
Antimony	3 laboratories	-	0,002-0,005
	values not stated	-	0,004-0,010
Arsenic	0,007-0,3(6)	0,01	<0,04-0,24
	0,009-0,2(5)	0,01	<0,05-1,58
Barium	-	-	<0,3(<0,13)
	-	-	<0,6(<0,21)
Cesium	-	-	<0,00005
	-	-	<0,0005
Chromium	3 laboratories	17	0,027
		0,5	1,1
Cobalt	1 laboratory	-	0,0012
	values not stated	-	0,002-0,9
Europium	-	-	0,0003
	-	-	<0,0002
Gold	0,00003-0,6	0,00003	0,004-0,026
	0,00007-0,2	0,0001	0,004-0,156
Iron	-	-	<1,5(<0,7)
	-	-	<3(<1,2)
Lanthanum	1 laboratory	-	0,02-0,09
	values not stated	-	0,3-2,3
Rubidium	-	-	<0,06(<0,03)
	-	-	<0,12(<0,06)
Ruthenium	-	-	<0,04
	-	-	2,5
Scandium (Sc+Ti)	1 laboratory	-	0,00008-0,0008
	values not stated	-	0,001-0,003
Selenium	-	-	0,006-0,08
	-	-	0,01-2
Silver	3 laboratories	-	0,027
	values not stated	-	0,1-0,4
Uranium	-	-	0,006-0,2
	-	-	0,013-0,06
Zinc	1	-	0,2-0,4
	0,5	-	0,2-0,6

Table 1 Compilation of elemental contents [ng/g] found in semiconductor silicon
(upper lines: Wafer 1, lower lines: Wafer 2)

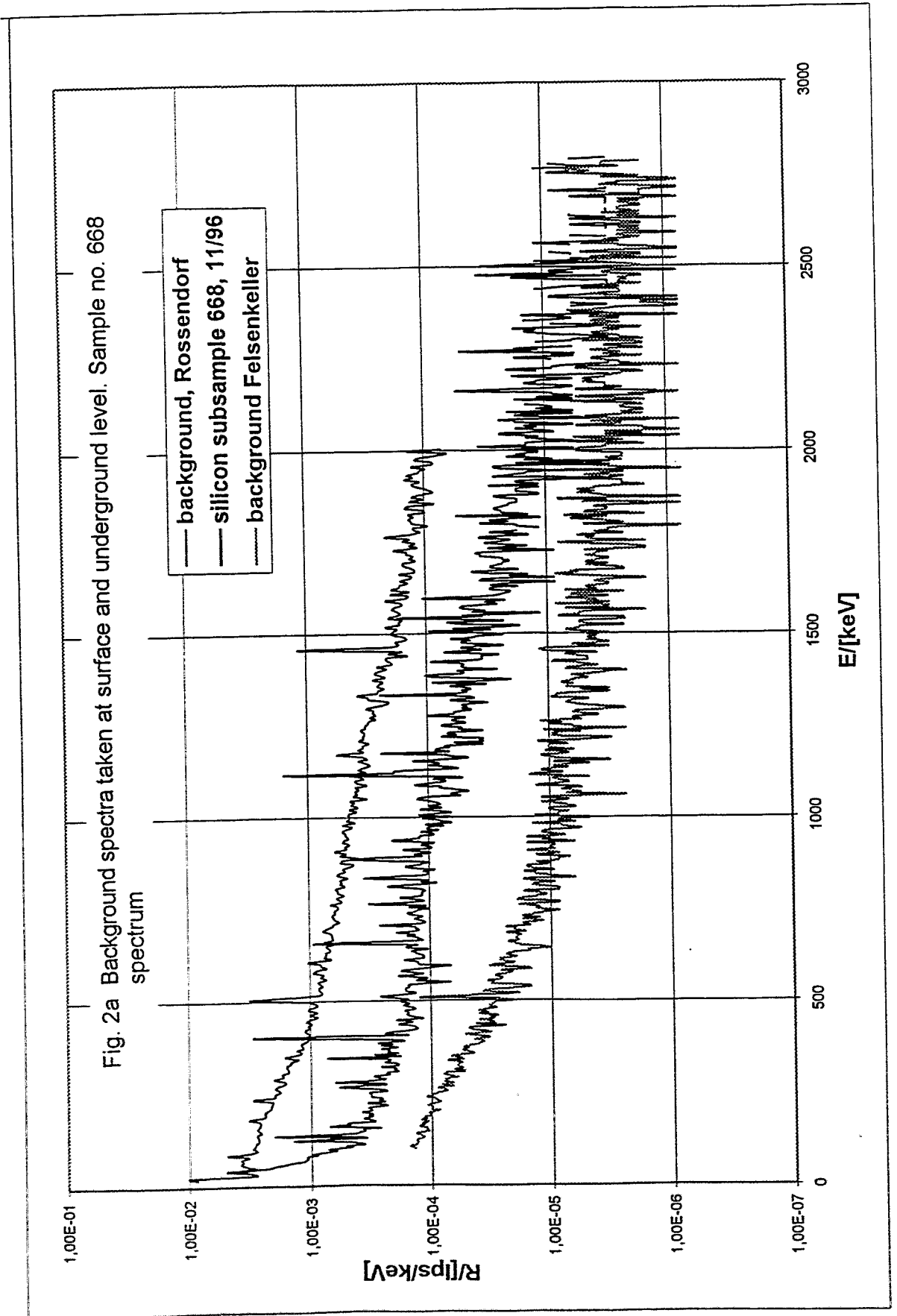

Fig. 2a Background spectra taken at surface and underground level. Sample no. 668 spectrum

— background, Rossendorf
 — silicon subsample 668, 11/96
 — background Felsenkeller

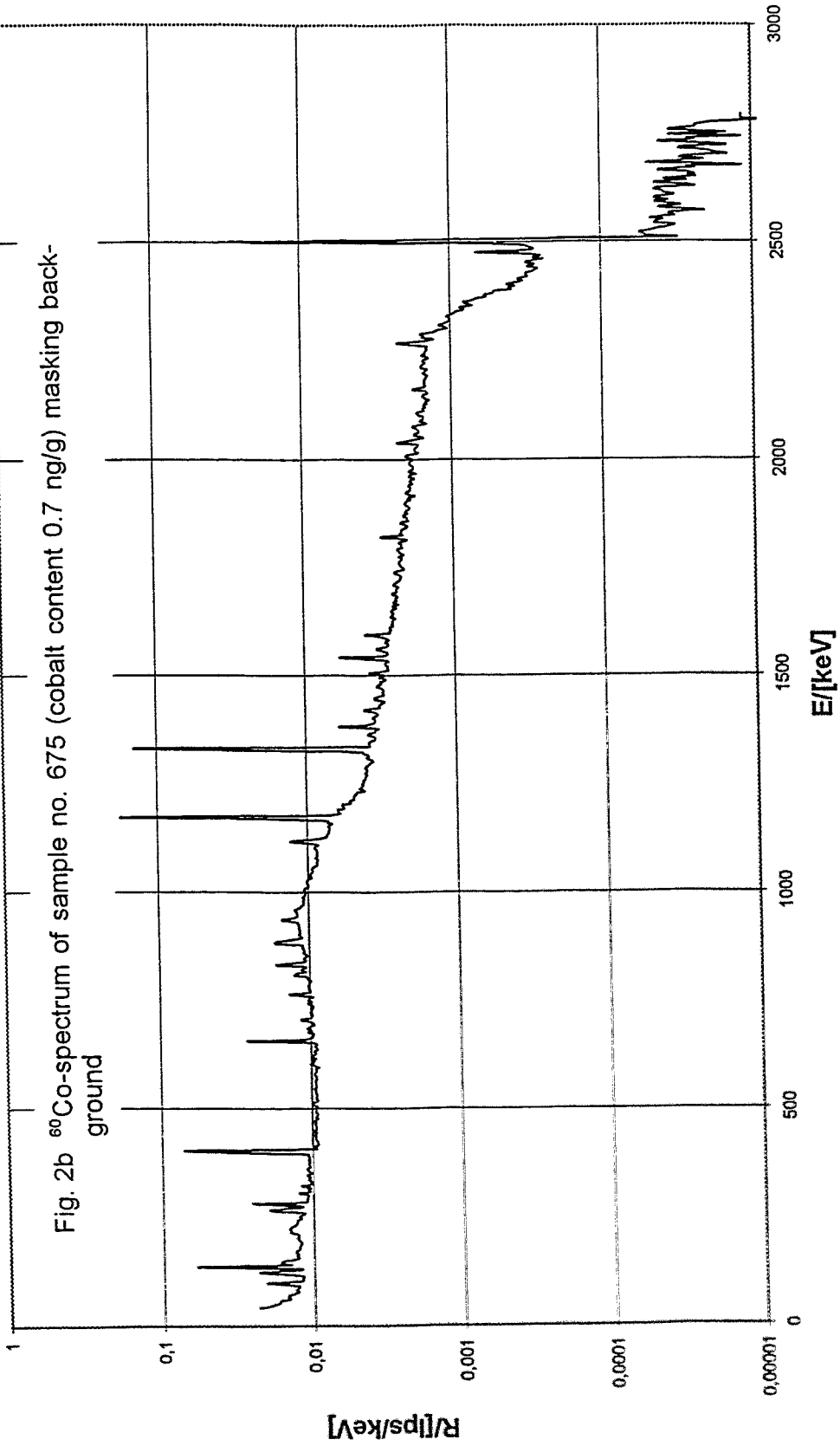

Fig. 2b ^{60}Co -spectrum of sample no. 675 (cobalt content 0.7 ng/g) masking back-ground

	DD	B	DD	B	DD	B	DD	B	DD	B	DD	B
Sample	Chromium		Cobalt		Scandium		Selenium		Silver		Zinc	
665	0,10	0,10	0,0018	<0,005		0,0005		0,028	0,047	0,070	0,10	0,20
666	0,15	0,10	0,0017	0,005	0,00081	0,001	0,077	0,065	0,045	0,055	0,32	0,39
667		0,09		0,01		0,001		0,064		<0,08	0,06	0,39
668		0,07		<0,004	0,00008	0,001	0,006	0,124		<0,09	0,05	0,30
669	0,04	0,04	0,001	<0,004	0,00072	0,001	0,025	0,21	0,035	0,065	0,27	0,42
673	0,21	0,17	0,0038	<0,004		<0,001	0,011	0,018	0,20	0,407	0,18	0,23
674	0,80	0,71	0,15	0,20	0,0015	0,001	0,19	0,073	0,34	0,727	0,20	0,35
675	1,10	0,97	0,65	0,91	0,0024	0,002	1,2	0,807	0,28	0,690	0,53	0,51
676	0,30	0,29	0,024	0,029	0,0034	0,004	2,1	1,83	0,18	0,390	0,35	0,50
677	0,32	0,31	0,0024	0,009	0,0015	0,002	0,43	0,396	0,088	0,186	0,30	0,58

Table 2 Comparison of Dresden (DD) an Berlin (B) results (contents in ng/g)

References

- 1 W. Helbig, S. Niese, Nucl. Instruments and Methods in Phys. Res., B 17(1986)431
- 2 M.N. Schulepnikow et al., J. Radioanal. Nucl. Chem., 122(1988)261
- 3 M.L. Verheijke, "Instrumental NAA Developed for Silicon Integrated Circuit Technology", Ph.D.Thesis, Tech. Univ. Eindhoven (1992)117
- 4 D.A. Becker et al. "Semiconductor Characterization, Present Status and Future Needs" AIP-Press (1996)335

LOW-LEVEL GAMMA SPECTROMETRY OF FOREST AND MOOR SOILS FROM EXPOSED MOUNTAIN REGIONS IN SAXONY (ERZGEBIRGE)

Nanette Schleich, Werner Preusse, Detlev Degering and Sepp Unterricker

Institute of Applied Physics, TU Bergakademie Freiberg, D-09596 Freiberg, Germany

Introduction

In soils with distinct organic and mineral horizons, radionuclides (RN) can be used to understand geochemical migration processes.

In the study presented here high sensitivity HPGe-detectors with active and passive shielding were employed to determine the low activity levels of various natural, cosmogenic and artificial RN. Soils of a spruce forest and a moor from exposed mountain regions in Saxony (Erzgebirge) were investigated as they provide a good example of layered soil systems with vertical transfer of chemical elements. Different soil horizons were sub-sampled as thin slices and analysed to examine the migration processes at sub-horizon level. The depth distributions of chemically different RN were studied considering the geochemical and pedological soil characteristics of the profiles.

Instrumentation

For the measurements of the forest soil samples a gamma spectrometer with a 36% p-type low-level HPGe-detector was used (PREUSSE & UNTERRICKER 1994). The detector is surrounded by a passive shield consisting of 4 cm radiopure copper in the innermost part, 2 cm mercury in steel containers with low ^{60}Co activity, 4 cm lead with low ^{210}Pb activity and 7 cm normal lead at the outside. The cosmic ray induced background spectrum is reduced by an anticoincidence shield which consists of three multiwire proportional counters. The moor soil measurements were carried out by a 38% n-type low-level HPGe-detector with a thin dead layer and a crystal encapsulated only by aluminium. For this reason the detector can be used for Marinelli beakers in the lower energy range as well. Both detectors are situated above ground level.

Applying these equipments weak activities of natural RN (^{232}Th , ^{235}U and ^{238}U decay chain RN including ^{210}Pb ; ^{40}K), cosmogenic RN (^7Be) and artificial RN ($^{106}\text{Ru}/^{106}\text{Rh}$, ^{125}Sb , ^{154}Eu , ^{134}Cs , ^{137}Cs and ^{241}Am) have been detected in natural samples. The very low activity concentrations of the RN in the described soils require measurement times up to 4 days. After sealing the Marinelli beakers were stored for some time to ensure the ^{222}Rn equilibrium.

Sampling

Sampling sites and soil samples are characterized in detail in the following table.

	Moor <i>Kleiner Kranichsee</i>	Spruce forest <i>Holzchau</i>
location	at the crest of the western <i>Erzgebirge</i> , near Johanngeorgenstadt	near the mountain crest of the <i>Erzgebirge</i> , 50 km southwest of Dresden
altitude above sea level	930 m	750 m
geological conditions	andalusite mica rock / granite	granite (<i>Flayer Granit</i>)
soil	moor (sphagnum mosses)	podzolic
vegetation	cotton grass, heather, sedge	100% spruce
sampling date	July 11, 1996	April 29, 1994
sampled area	40 x 40 cm ²	50 x 50 cm ²
preparation	dried at 40°C	dried at 105°C, sieved ≤ 2 mm

The moor profile was cut into thin well-defined slices in the laboratory. The forest soil was horizontally separated following the German soil classification (AG BODENKUNDE 1994).

Results and discussion

Fig. 1 shows selected depth profiles of the moor sampling site *Kleiner Kranichsee*. ^{241}Am ($T_{1/2} = 432.7$ y), deposited mainly after the nuclear weapon tests in the sixties, has its activity maximum at 12 cm depth and is detectable down to a depth of 22 cm. ^{125}Sb ($T_{1/2} = 2.73$ y), deposited by atmospheric fallout of the Chernobyl accident in 1986, reveals its maximum at a depth of about 4 cm, being detectable to 12 cm depth. The ^{210}Pb level decreases with the depth, with the highest value at the uppermost recent layer. A discontinuity between 5 and 15 cm depth could be explained by enrichment of ^{210}Pb in roots (e.g. of the cotton grass). Cosmogenic ^7Be ($T_{1/2} = 53.3$ d) decreases very fast with depth and is only detectable down to 10 cm.

Assuming a growth of the uppermost layers of about 1mm/y, as estimated for the moors of the *Erzgebirge* (VOLKMANN 1996), the maxima of ^{125}Sb and ^{241}Am distributions could be explained by a strong sorption to the deposited organic material and a minor influence of migration. In comparison, ^7Be seems to be much more mobile as the profile can not be explained only by the effect of decay.

The specific activities of ^{134}Cs and ^{137}Cs decrease with depth. ^{134}Cs can be determined down to a depth of 20 cm. Using an assumed Chernobyl activity ratio (^{137}Cs to ^{134}Cs) of 1.9 the bomb ^{137}Cs was calculated. Compared to the part coming from the Chernobyl accident, the bomb ^{137}Cs distribution seems to be rather smeared.

Depth profiles of the spruce forest sampling site *Holzau* (SCHLEICH et al. 1995) are presented in **Fig. 2**. The specific activity of ^{241}Am shows a sharp maximum in the organic Oh horizon. It is detectable only in the organic and humic horizons. The maximum value of ^{125}Sb is observed in the organic Of/Oh horizon. In contrast to the case of ^{241}Am small concentrations of ^{125}Sb are detectable even in the uppermost mineral horizons. The Chernobyl ^{137}Cs distribution is comparable to the distribution of ^{125}Sb , although it decreases slower. The deepest maximum of artificial RN is measured for bomb ^{137}Cs . In contrast to the moor soil the depth distributions of Cs nuclides show characteristic maxima in forest soil horizons. The values of ^{238}U and ^{226}Ra both increase with depth. Although they show a disequilibrium in $B_{(3)}$ and $B_{(4)}$ they reach the same final limit in deeper mineral unconsolidated horizons (33 cm). The profile of ^{210}Pb has a maximum in the organic Of/Oh horizon. Below the mineral $B_{(3)}$ horizon the ^{210}Pb value is equal to the specific activity of the ^{226}Ra daughters indicating $^{226}\text{Ra}/^{210}\text{Pb}$ equilibrium. As expected ^{228}Th and ^{228}Ra are in equilibrium. Their specific activities increase with depth and reach a final value in the weathering horizons (B) corresponding to the specific activity of a sample taken at a depth of 33 cm.

Acknowledgements

We thank V. Geyer (forester of district Holzau) for kindly support. We are grateful to M. Seifert for help in moor sampling (*Landesamt für Umwelt und Geologie, Freiberg*). N. Schleich thanks for the grant of the *Hanns-Seidel-Stiftung, München*.

References

- AG BODENKUNDE (1994): *Bodenkundliche Kartieranleitung*. Hannover, 392 S.
- PREUSSE W & UNTERRICKER S (1994): The contribution of cosmic ray muons to the background spectrum of gamma ray spectrometers. *Nucl. Instr. and Meth. in Phys. Res. B* 94, 569-574.
- SCHLEICH N, UNTERRICKER S & PREUSSE W (1995): Monitoring and Analytics of Uranium Series Radionuclides in the Upper Horizons of Different Soils. *Int. Conf. Uranium Mining and Hydrology, Freiberg 1995, Proc. No. 1*, 511-518.
- VOLKMANN N (1996): private communication.

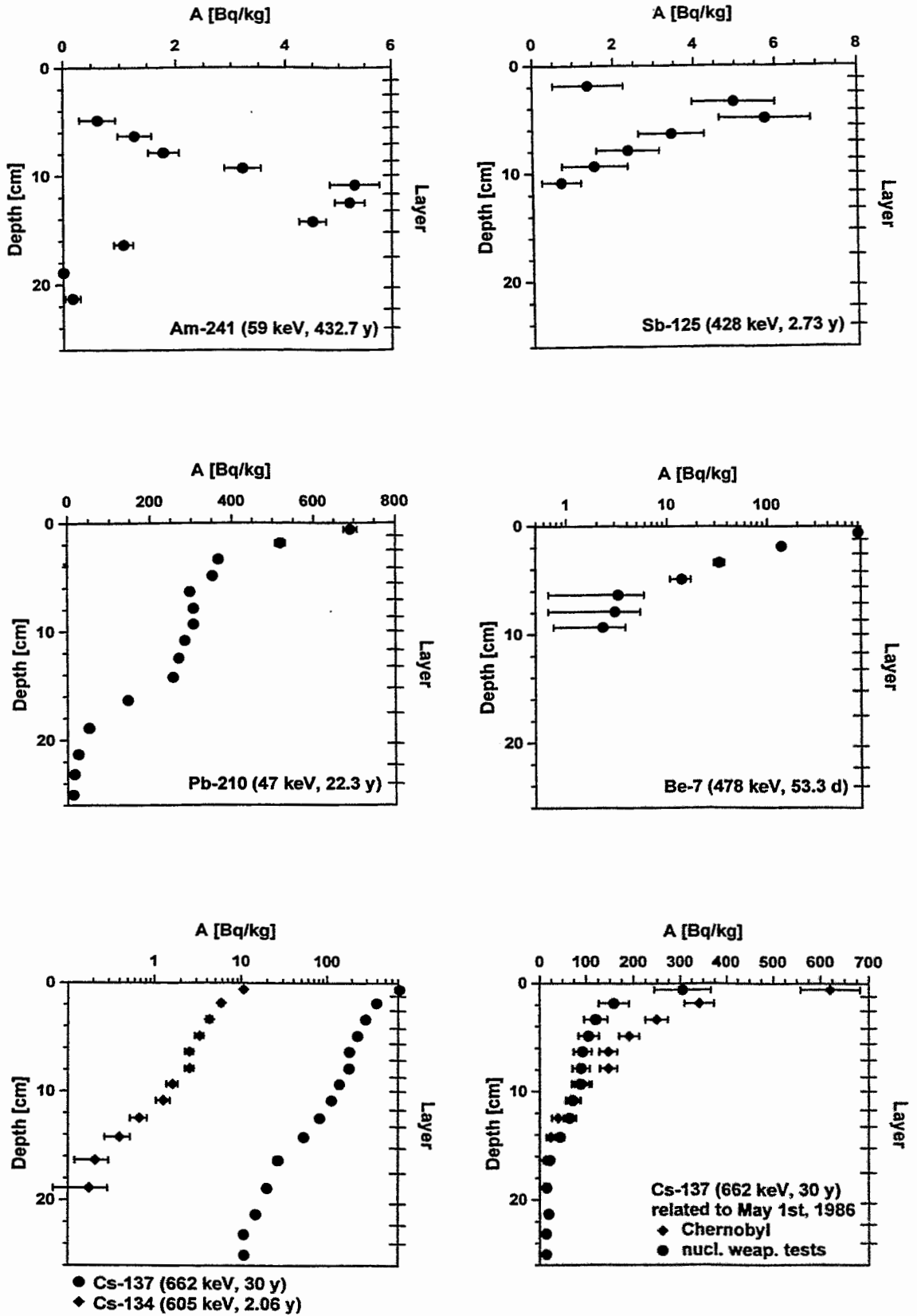

Fig. 1: Depth profiles of selected RN at the sampling site *Kleiner Kranichsee* (2 σ error bars). All specific activities are related to 07/96 if not otherwise indicated.

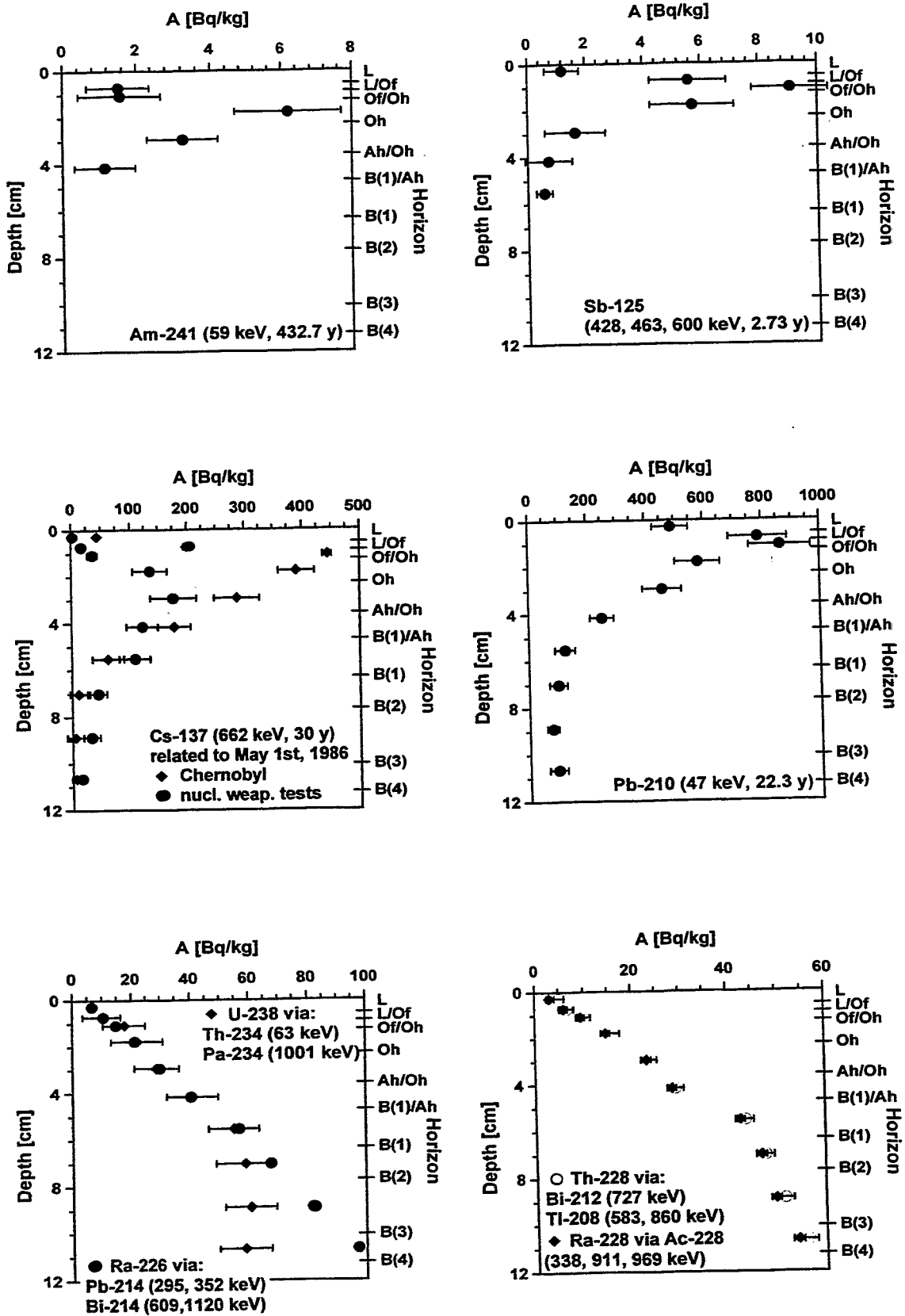

Fig. 2: Depth profiles of selected RN at the sampling site Holzhaus (2 σ error bars). All specific activities are related to 04/94 if not otherwise indicated.

INVESTIGATION OF ENVIRONMENTAL SAMPLES BY LOW-LEVEL GAMMA SPECTROMETRY

M. Köhler, S. Niese

Nuclear Engineering and Analytics Rossendorf Inc. (VKTA)

Introduction

Background reduction is one way to improve the sensitivity of gamma ray measurements. The figure 1 shows a comparison of background spectra from a typical gamma spectrometer above ground, from our underground laboratory *Felsenkeller* (125 m w.e.) and as an example for a deep underground laboratory a spectrum from the Gran Sasso laboratory (3500 m w.e.). The typical integral count rate in the energy region of 30 keV to 2,7 MeV of about 4,5 cpm/kg demonstrates the background reduction in our laboratory by a factor of 30.

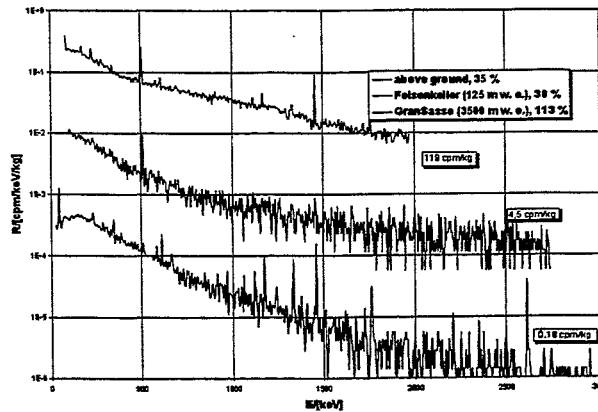

Figure 1
Comparison of background spectra from underground laboratories at different depth

We have installed four coaxial n-type HPGe-detectors with 20 to 40 % of relative efficiency, one low energy detector (semiplanar, n-type HPGe, 2 cm thick) and one well-type detector. All detectors are low-level configurations with lead shielding from 10 to 17 cm thickness. This instrumentation is completed by a liquid scintillation counter *Quantulus*, an alpha spectrometer and a whole body counting system (figure 2).

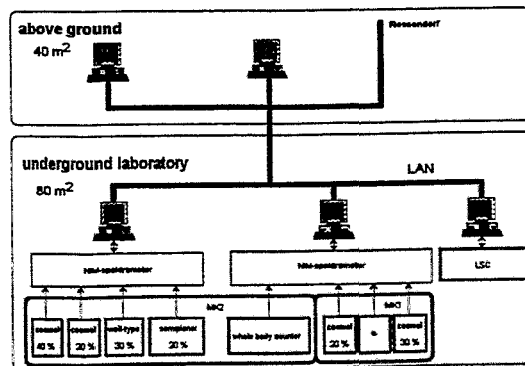

Figure 2
Equipment at underground laboratory *Felsenkeller*

The question is, how are these possibilities (many detectors under relative good conditions) used? What kind of measurements we are doing?

The average sample number in our laboratory is about 200 per month (12 % technical solid state, 30 % geological solid state, 6 % geological solid state with low mass, 12 % biological, 11 % water directly, 25 % water after chemical separation, 4 % others). In 54 % of the measurements the background continuum, and though the detection limit, is determined only by the detector himself and not by the compton continuum from high energy lines in the sample. Some examples in the presented work aim to prove the advantages of gamma ray spectrometry in the underground laboratory *Felsenkeller*.

Water samples

Direct measurements

A comparison experiment of environmental water samples with equivalent detector systems above ground and underground demonstrates, that the detection limit of gamma nuclides (natural or artificial) measured underground is lower by a factor of 6 (table 1). This means that the counting interval with required detection limits is 30 times lower.

nuclide	underground g* / [Bq/l]	above ground g* / [Bq/l]
²³⁴ Th	0,063	0,35
^{234m} Pa	0,22	1,2
²³⁴ U	2,5	14
²³⁰ Th	0,60	3,3
²²⁶ Ra	0,040	0,22
²¹⁴ Pb/Bi	0,005	0,028
²¹⁰ Pb	0,12	0,66
²³⁵ U	0,025	0,14
²²⁷ Th	0,012	0,066
²²³ Ra	0,022	0,12
²²⁸ Ac	0,007	0,039
²¹² Pb	0,004	0,022
²⁰⁸ Tl	0,005	0,028
⁴⁰ K	0,025	0,14
¹³⁷ Cs	0,002	0,011

Table 1

Comparison of detection limits g* from water samples above ground and underground *Felsenkeller* (60 ks counting interval, 30 % detector, 0.45 l-Marinelli geometry, 2 l reference volume, calculated with DIN 25482 formalism)

Measurement of chemical isolated fractions

Gamma activities of 500 water samples from saxonian uranium mining areas were measured after a chemical separation of the radium isotopes. The short half-life period of ²²⁴Ra (3,6 d) and a large sample number (25 samples per charge) demands relatively short counting intervals (30 ks). The required detection limits of about 20 mBq/l (table 2) were received by reducing the background (going underground and measuring with selected detectors), by increasing the

efficiency (transition from Marinelli to area geometry) and by chemical separation (prevent the domination of the background by compton continuum).

	required	above ground	Felsenkeller	
	g* /[mBq/l]	g* /[mBq/l]	g* /[mBq/l]	g* /[mBq/l]
depth		0 m w. e.	110 m w. e.	110 m w. e.
geometry		Marinelli	Marinelli	area source
separation		no	no	yes
reference volume / [l]		2	2	2
²²⁶ Ra	40	310	52	28
²¹⁰ Pb	40	920	150	30
²²⁴ Ra	20	31	5	3
²²⁸ Ra	20	55	10	10

Table 2
Required and measured detection limits g* for water samples

Solid samples

Particle size distribution

The rehabilitation of old uranium mining areas requires the transportation of about 10 million tons of rock material with activities of 500 Bg/kg. The movement produces dust particles which can be incorporated by inhalation ($d < 20 \mu\text{m}$) and ingestion ($d < 500 \mu\text{m}$). Radiation dose calculation for the working persons and for the population must consider the specific activities in these fractions. The destination of the research¹ is the measurement of the specific activity in the sample parts with particle diameter lower then 20 and 500 μm and to check the possibility of routine measurements with mixed samples instead of the fractions.

First of all a particle size analysis in the range from 5 μm to 2 mm was performed, using a mechanical sieve machine (riddle) for particle diameters greater then 20 μm and an ultrasonic sieve equipment for diameters below 20 μm . All analysis were done with water. In the fractions below 20 μm sample masses of about 0.5 g were received.

The activities of the lower fractions were measured in a well-type detector in test-tube geometry and for larger sample mass with coaxial detectors in cylindrical geometry. In all fractions the particle size is reduced to $< 63 \mu\text{m}$ and all samples are airtight packed to enable the determination of ²²⁶Ra by their daughter nuclides ²¹⁴Pb/²¹⁴Bi. The self-attenuation in the sample with density as parameter was corrected. These correction coefficients are experimental determined on the base of spiked material in the density range from 0.5 to 2.0 g/cm³. A solution of a uranium mineral (pitchblende) with all nuclides in equilibrium was used. Because of the increasing coincidence summing effects in the well-type detector (80 % efficiency at 100 keV) a nuclide specific calibration without curve fit was done. For this reason the usage of the pitchblende standard has several advantages. Because of the low sample mass (0.5 g) the

¹ financial support was given by *WISMUT Corporation*

specific activities of typically 1000 Bq/kg ^{238}U (figure 3) results in activities of about 25 mBq per sample for members of the ^{235}U -decay line in the fractions $d < 20 \mu\text{m}$. The constancy of the curve (figure 3a) demonstrates the correctness of the calibration for different detectors and geometry's and for the self attenuation correction.

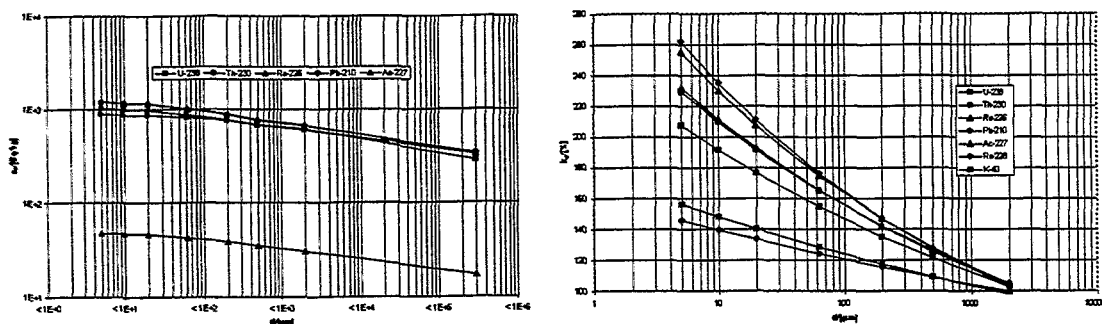

Figure 3

- a) Dependence of the specific activity a_d from the particle size limit d for a selected sample
- b) Mean activity upgrading function relative to the activity of the sample with particle diameter $d < 2 \text{ mm}$

The specific activity increases with the decreasing particle size. This upgrading is the same for all the nuclides in the decay line. For all investigated samples a mean activity upgrading function can be calculated (figure 3b). The fact of the activity upgrading can be interpreted by the location of the activity on the rock particle surface. In the case of a homogeneous contribution in the rock an activity upgrading is not possible to explain.

The result of the investigations is a method to determine the specific activities in the dose relevant particle fractions ($d < 20 \mu\text{m}$ for inhalation, $d < 0,5 \text{ mm}$ for ingestion): Simple measurements of a sample with particle size diameter lower then 2 mm and calculate the specific activities in the dose relevant fraction by using the dedicated upgrading factors.

Without consideration of the upgrading the calculated effective dose is lower by a factor of 5.

^{137}Cs profile

The figure 4 shows the distribution of the ^{137}Cs activity in sedimentation layers of the Malter dam near Dresden. The measurements are done in area source geometry on a coaxial detector. Typically activities in the sample (20 g) are 200 mBq with a detection limit of about 20 mBq. The visible maxima in the curve results from the Chernobyl accident in 1986 and from the atomic tests in atmosphere in the earlier sixties. These measurements give an approximation for the age of the sedimentation layers. A sedimentation rate could be estimated with $(2,2 \pm 0,7) \text{ cm/a}$.

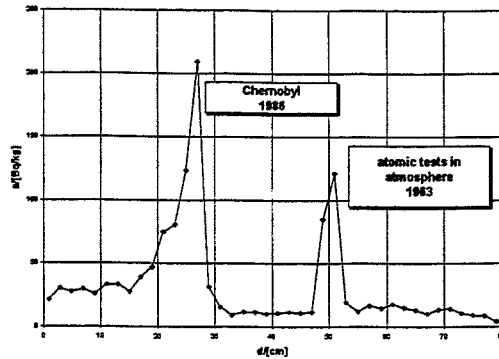

Figure 4
 Depth profile of the ^{137}Cs activity in a sediment of the Malter dam near Dresden

Other applications

In co-operation with the Federal Institute for Materials Research and Testing low-level spectrometry was applied to measurement of neutron activated samples of semiconductor silicon (see lecture *Neutron Activation Analysis of Low-Level Elemental Contents in Silicon Wafers*).

The whole body counter installed at the Felsenkeller laboratory makes use of the low dose rate from about 10 nSv/h.

(see lecture *Parameters of a Simple Whole Body Counter and Thyroid Monitor Established at the Dresden Felsenkeller Underground Laboratory*).

The calculation of the shielding layers in the new built measuring chamber needs much material selection and specification (lead bricks, steel plates, paintings, electrical installation material, limestone bricks). With the measured activities the contribution of each material to the photon flux and the resulting background is approximately calculated.

Conclusions

The examples show that an increasing field of low-level gamma spectrometry applications exists. Low-level gamma measurements are effectively done in a medium depth underground laboratory like Felsenkeller with low detection limits at short counting intervals and if large sample numbers are necessary.

Approximate Determination of Efficiency for Activity Measurements of Cylindrical Samples

W. Helbig, M. Bothe

Nuclear Engineering and Analytics Rossendorf INC (VKTA)

The problem of efficiency determination in gamma spektrometry

Many papers have been published dealing with the calculation of efficiency for radioactivity measurements by gamma spectrometry.

There exist extensive investigations [1] with samples of a wide density range obtained by various matrices. But the efficiency curves are intersecting one another, because of the different matrices. We see the difficulty, to select one curve for a sample with unknown composition. Moreover the immense work to set up the curves must be done for each detector separately.

A great mathematical expense was undertaken to gain computer programs for efficiency calculation based on many parameters of detector, sample and counting geometry [2].

These precautions are not given in our case, because we don't know the detector geometry. Other solutions substitute a point for the detector crystal [3].

Considering the wide energy range, which is to cover by such a model, this assumption is questionable. The average accuracy of the method is given as 12 %, but in some cases the difference between calculated and measured efficiencies is about 30 %.

Another problem in some papers is an evident difficulty to cover the low energy region.

Suggested solution for cylindrical samples

For routine analyses of samples in definite cylindrical geometry but unknown composition a simple semiempirical approximation approach will be suggested. The efficiency ϵ as a function of energy E is splitted into two terms:

$$\epsilon(E) = \epsilon_{geom}(E) \cdot \epsilon_{\mu}(E) \quad (1)$$

$\epsilon_{geom}(E)$ should include detector properties altogether, sample size (diameter, height) and counting geometry. The term $\epsilon_{geom}(E)$ is a function for an imaginary sample of desired geometry and of density 0 gcm^{-3} . $\epsilon_{\mu}(E)$ describes the influence of sample material, especially the absorption of gamma radiation in the sample itself, which is characterized by density ρ and mass absorption coefficient μ' [cm^2g^{-1}]. The product of both is the linear absorption coefficient $\mu = \mu' \rho$ [cm^{-1}]. The first task is to obtain $\epsilon_{geom}(E)$ for a definite detector and a given cylinder geometry. Once found, $\epsilon_{geom}(E)$ is valid for all samples of that geometry.

The second task is to find $\epsilon_{\mu}(E)$ for an unknown sample material. Any new sample material requires to set up its own function $\epsilon_{\mu}(E)$. By multiplication of this $\epsilon_{\mu}(E)$ with $\epsilon_{geom}(E)$ - for a sufficient number of points - the efficiency function $\epsilon(E)$ for a certain sample is obtained.

Description of the procedure

Some calibration samples are necessary with the same geometrical parameters but of different materials, containing known activities A homogeneously distributed. Their densities are measured, their mass absorption coefficients may be unknown.

These calibration samples are positioned in the counting geometry, for instance directly on the detector. The efficiency function $\epsilon(E)$ for each sample is gained by measuring the gamma spectra and evaluating all usable gamma energy peaks. From these $\epsilon(E)$ the common valid $\epsilon_{\text{geom}}(E)$ will be deduced.

For this purpose the functions $\epsilon_{\mu}(E)$ for these samples have to be established.

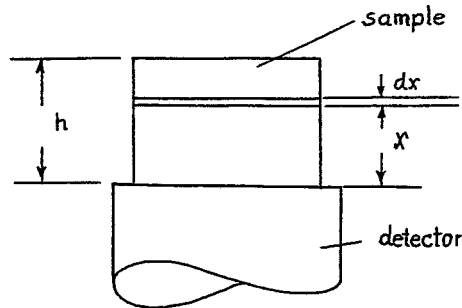

Fig. 1: Measuring geometry

For the derivation of ϵ_{μ} we approximate the count rate contribution dI of a differential thin cylinder layer, containing the activity dA and assuming axial radiation path distance x (fig. 1).

$$dI = e^{-\mu x} \cdot dA$$

By integration follows:

$$I = \frac{A}{h \cdot \mu} (1 - e^{-\mu h})$$

For ϵ_{μ} results

$$\epsilon_{\mu} = \frac{I}{A} = \frac{1}{h \cdot \mu} (1 - e^{-\mu h}) \quad (2)$$

To eliminate μ in equation (2) we use absorption measurements with point sources of nuclides with convenient energies in a suitable arrangement (fig. 2).

For the count rates i of these absorption measurements and the corresponding rates i_0 for an empty sample box instead of the sample we write

$$\frac{i}{i_0} = e^{-\mu h}$$

$$\mu \cdot h = \ln \frac{i_0}{i}$$

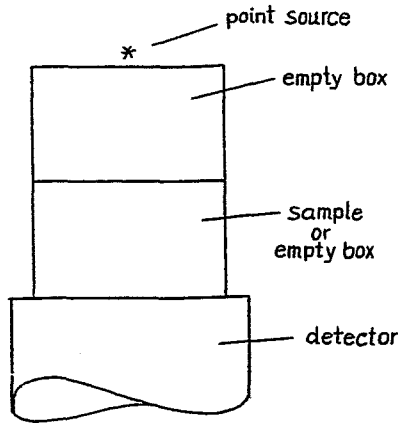

Fig. 2: Measuring geometry for absorption measurements

And in equation (2):

$$\epsilon_{\mu} = \frac{1 - \frac{i}{i_0}}{\ln \frac{i_0}{i}}$$

The function $\epsilon_{\mu}(E)$ is obtained by combining the results of measurements of different nuclides. For each calibration sample the corresponding functions $\epsilon(E)$ and $\epsilon_{\mu}(E)$ are coupled by equation (1) to

$$\epsilon_{geom} = \frac{\epsilon}{\epsilon_{\mu}} \quad (3)$$

Although the functions $\epsilon(E)$ and $\epsilon_{\mu}(E)$ are essentially different from sample to sample, their quotients ϵ_{geom} are expected to be equal. This would be an important confirmation for the capability of the method.

Results

Some experimental results illustrate the method. Two calibration samples of 66 mm diameter and 34 mm height with about 2000 Bq U-238 and 100 Bq U-235 from pitchblende were measured on a 30 % n-type HP-Ge-detector (GMX-3 in our notation). One sample consists of a soil mixture with density 1.5 gcm^{-3} (St-06); the other one of pumic-stone grains with 0.5 gcm^{-3} (St-09). By evaluation of energy peaks at 46.5; 63.3; 92.6; 163.4; 205 and 1001 keV the shown efficiency functions were obtained (fig. 3)

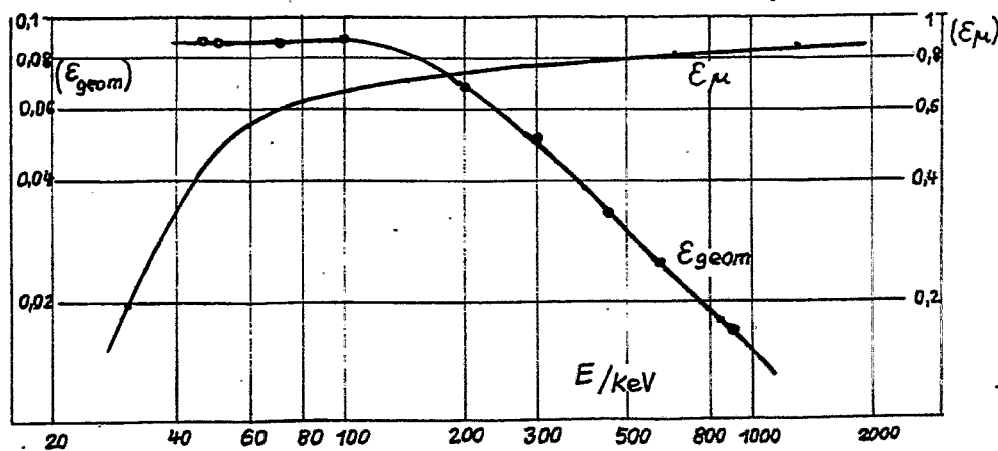
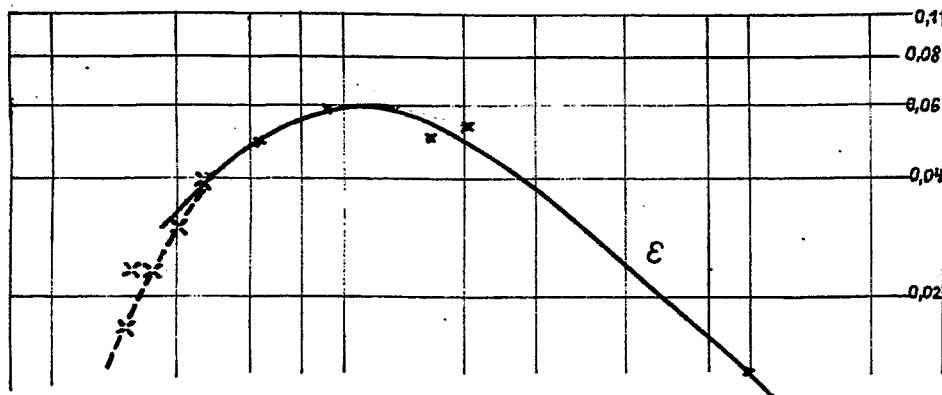
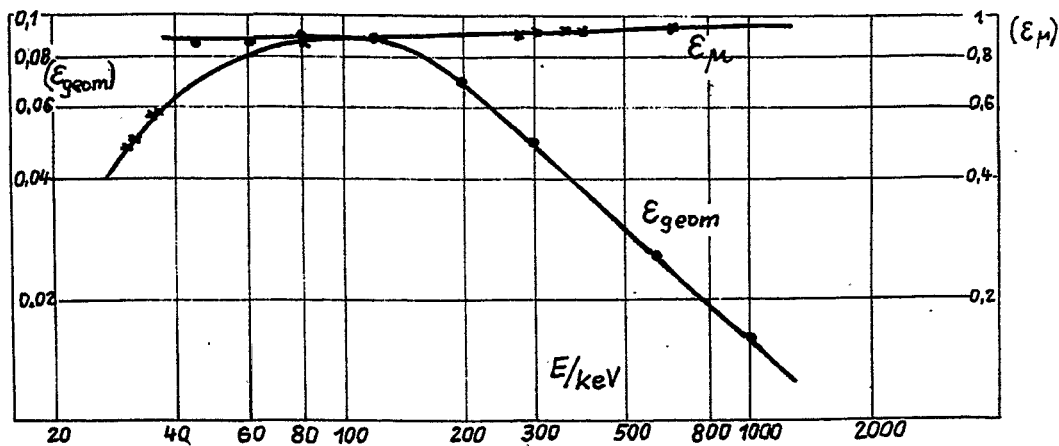
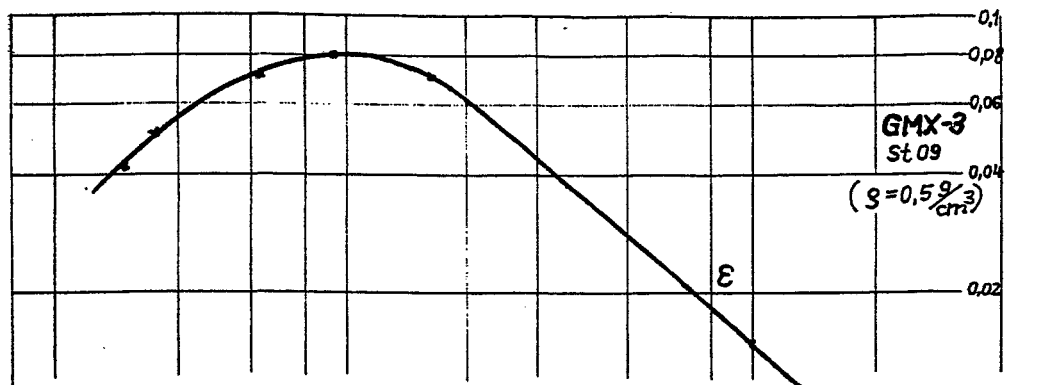

GMX-3
St 06
($\rho = 1,59 \frac{g}{cm^3}$)

Fig. 3: ϵ , ϵ_{geom} and ϵ_{μ} for calibration standards with different densities

Absorption measurements of Am-241, Ba-133, Cs-137 and Co-60 point sources with these samples yielded the ϵ_μ for discrete energies of above-mentioned nuclides by equation (3) and the ϵ_μ -functions could be drawn. Computation of quotients ϵ/ϵ_μ for some discrete energies enables us to construct the functions $\epsilon_{geom}(E)$ (fig. 3). These $\epsilon_{geom}(E)$ for both samples agree very well (fig. 4). This correspondence we found also in all other cases which we examined. In the next diagram the functions ϵ_{geom} are drawn for different heights of samples (fig. 5)

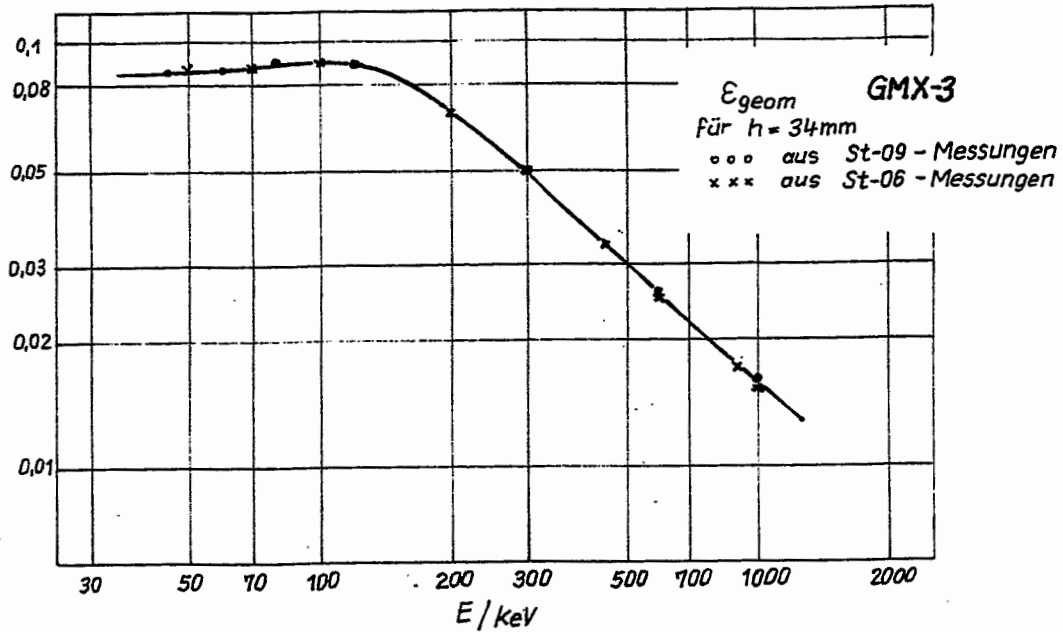

Fig. 4: Comparison of ϵ_{geom} for calibration standards with different densities

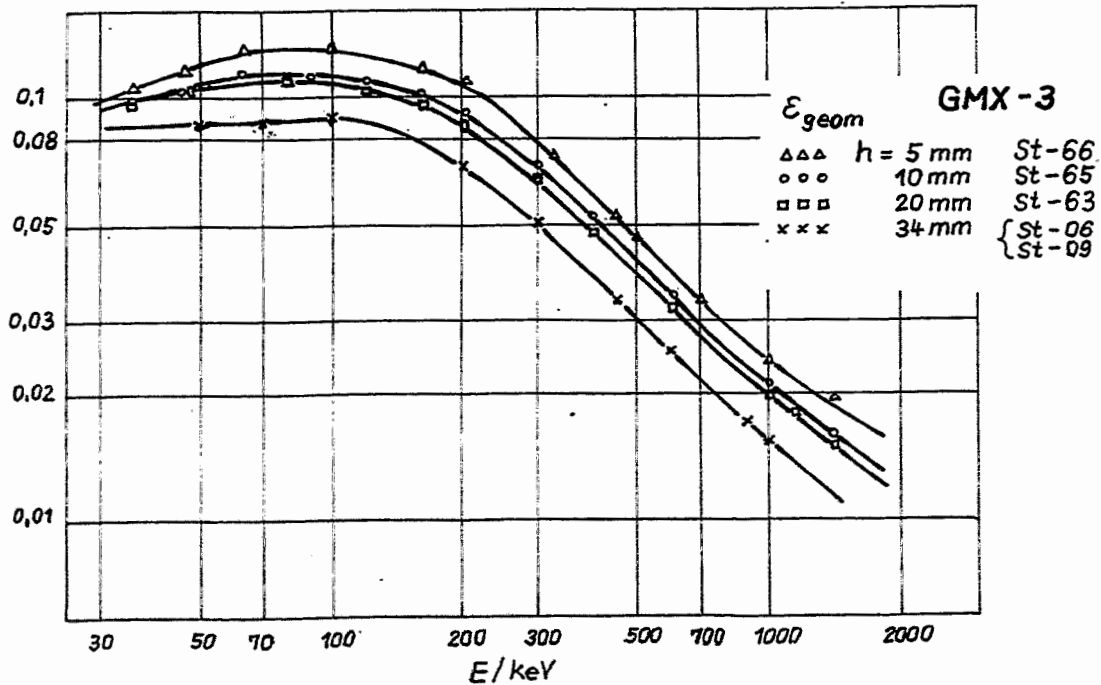

Fig. 5: Comparison of ϵ_{geom} for samples with different heights

Interesting aspects of these measurements are moreover:

- The functions $\epsilon_\mu(E)$, gained with one sample on different detectors, agree between each other (fig. 6). Once obtained from one detector, $\epsilon_\mu(E)$ can be used for other detectors without additional measurements.

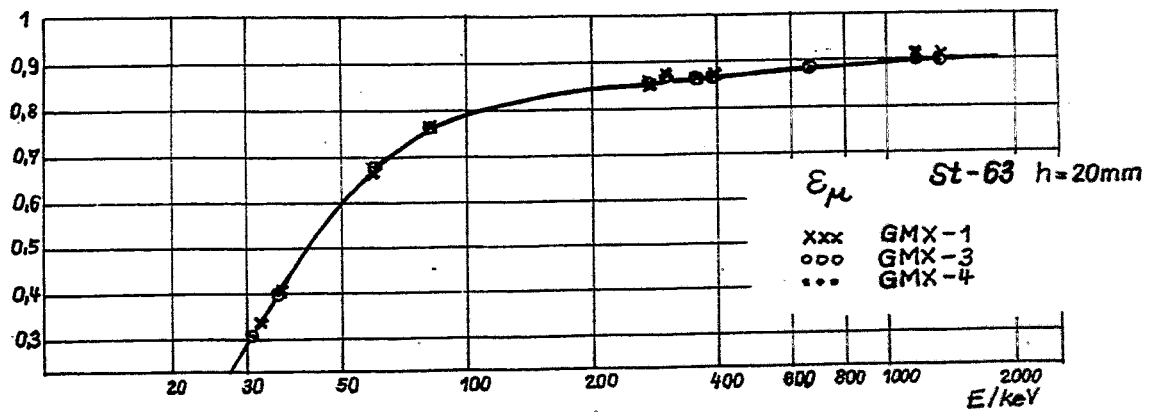
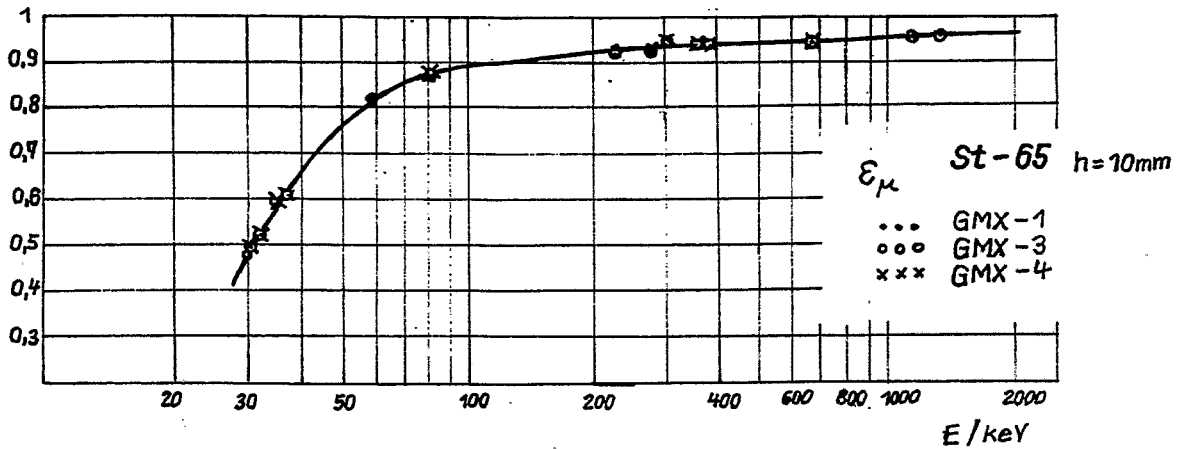
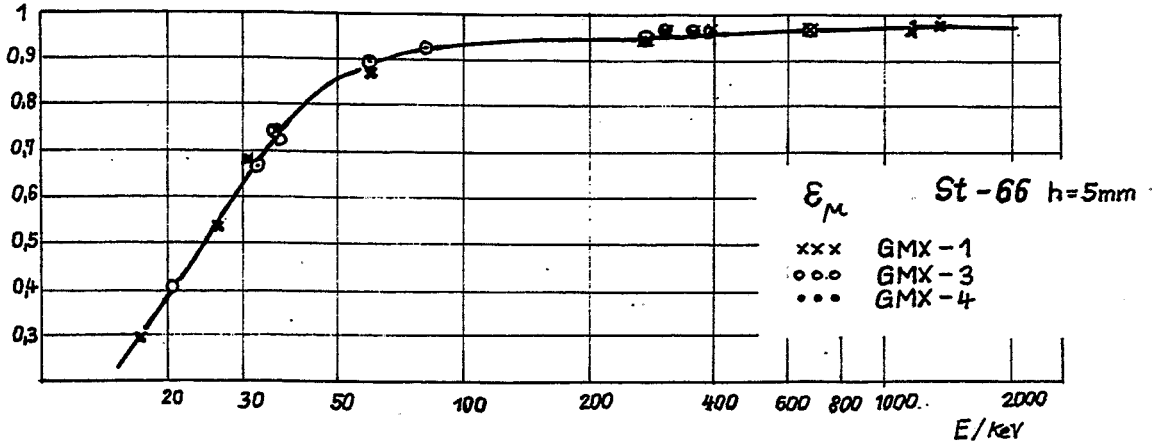

Fig. 6: Comparison of ϵ_μ for different detectors

- The functions $\epsilon_{\text{geom}}(E)$ show in the low energy range an almost constant run. So we can easily test the reliability of function $\epsilon(E)$ in this difficult energy range, because ϵ_p can be obtained there rather reliable, and also ϵ_{geom} is well known by the course mentioned.

Literature:

- [1] W.K. Nemeth, B. Parsa
Radioactivity and Radiochemistry 3 (1992), 32-39
- [2] L. Moeus et al.
Nuclear Instruments and Methods 187 (1981), 451-471
- [3] L. Zikovsky, B. Chah
Nuclear Instrumens and Methods, Phys. Res. A 263 (1988) 483 - 486

SPECIFIC CALIBRATION PROBLEMS FOR
GAMMASPECTROMETRIC MEASUREMENTS OF LOW-LEVEL RADIOACTIVITY
IN ENVIRONMENTAL SAMPLES

D. Arnold and H. Wershofen

Physikalisch-Technische Bundesanstalt, Bundesallee 100, 38116 Braunschweig

Introduction

Gammaspectrometric measurements of low-level radioactivity in environmental samples are always done in a close source detector geometry. This geometry causes coincidence-summing effects for measurements of multi-photon emitting nuclides. The measurements of radioactivity in environmental samples are also influenced by the absorption of photons in the materials which have to be analysed. Both effects must be taken into account by correction factors with respect to an energy-specific calibration of the detector system for a given geometry and a given composition of the calibration source. The importance of these corrections is emphasized. It is the aim of the present paper to compare different experimental and theoretical methods for the determination of these correction factors published by various authors and to report about efforts to refine them.

Self-attenuation

Gammaspectrometric measurements in the field of environmental radioactivity always aim to achieve low detection limits for the specific activity in a sample. Therefore extended containers like Marinelli beakers (typical volumes 450 to 3000 cm³) or cylindrical boxes (10 to 1000 cm³) are filled with the sample material and placed on the top of a detector. The detector system is generally calibrated in the same source-detector geometry. It is a common procedure to fill the containers with a mixed nuclide solution of known activity. But different compositions and densities of the calibration source and the sample cause different self-attenuations in both materials. This effect has to be measured or calculated to determine the right activity of the sample. Measurements and calculations are based on the well known attenuation law. In the special case of a beam of photons entering a layer of thickness t perpendicular to the surface, the number of transmitted photons N is given in terms of the original beam intensity N_0 by

$$N = N_0 \cdot e^{-\mu t} = N_0 \cdot e^{-\frac{\mu}{\rho} \rho t} \quad (1)$$

where μ is the (photon energy, material and density specific) linear attenuation coefficient, ρ is the density and μ/ρ is the mass attenuation coefficient. Table 1, taken as a part from tables given in [1], show the mass attenuation coefficients for several mixtures and compounds. It has to be pointed out that the higher the photon energy is the more are the mass attenuation coefficients comparable to each other. Looking to the second part of equation (1) this means that the attenuation for higher photon energy is (more or less) only a function of the density whereas for lower photon energy the attenuation varies strongly

with the composition of the material. Therefore every calculation of self-attenuation in an environmental sample for low photon energies (up to 200 - 300 keV) requires (experimental) informations about the element-specific composition of the sample.

Table 1: Mass attenuation coefficients μ/ρ for several mixtures and elements as a function of the photon Energy E .

E in keV	μ/ρ in cm^2/g			
	H_2O $\rho=(1 \text{ g/cm}^3)$	SiO_2 $\rho=(1.5 \text{ g/cm}^3)$	Ge $\rho=(5.33 \text{ g/cm}^3)$	Pb $\rho=(11.34 \text{ g/cm}^3)$
50	0.2262	0.3165	3.314	8.041
100	0.1707	0.1682	0.5525	5.550
300	0.1187	0.1076	0.1130	0.4026
500	0.09687	0.08738	0.08212	0.1613
1000	0.07070	0.06366	0.05728	0.07103
1500	0.05755	0.05185	0.04658	0.05222

An often used experimental method for the determination of self-attenuation in a sample has been developed by Cutshall et al. [2]. They proposed to fill the sample material in a cylindrical box and to place it between a detector and a point source. The point source should cover a radionuclide which emits photons with energies of interest (e.g. ^{210}Pb with $E= 46.5$ keV gamma-rays). From the measurements with and without the sample they calculate the self-attenuation in the sample for the energies of photons emitted by the point source. The equations they used are correct if the point source and the sample are placed in a greater distance to the detector. The more the distance is reduced the more the calculations become an approximation for the determination of the self-attenuation.

Another experimental method is to add standardized activity solutions to the sample of interest. From the measurements without and with these solutions the self-attenuation can be directly calculated. The main problem of this method is to achieve a homogenized mixture of the sample and the added activity. A minor problem are the costs and the availability of the standardized solutions.

As mentioned above, all calculations of self-attenuation require information about the composition of the sample material (e.g. results from mass spectrometry or X-ray fluorescence measurements). The mass attenuation coefficients can be calculated for example with computer programs like XCOM [3] if the composition is known. There are also some computer programs described in literature for the calculation of the self-attenuation in a sample in comparison to the self-attenuation in a calibration source using the mass attenuation coefficients of both sources. Debertain et al. [4] developed a program where the detector is considered as a point in the centre of the crystal. From every emission point inside a cylindrical container (or Marinelli beaker) the path length through the sample material and the corresponding attenuation is calculated. An integration over all emission points gives the requested self-attenuation. This type of approximation is used in a commercial program which is available from Amersham [5] since one year.

We have also tested a Monte Carlo program which was developed by Sima et al. [6-8]. The self-attenuation corrections for measurements with cylindrical containers or Marinelli beakers on coaxial- or planar-type detectors as well as for measurements with cylindrical containers inside of well-type detectors can be calculated with the help of this program.

We find a good agreement between experimental data and calculations even for very high attenuation corrections up to a factor of 10 (e.g. attenuation of ^{210}Pb gamma-rays with $E = 46.5$ keV in $\text{Pb}(\text{NO}_3)_2$) [9]. The advantage of the program is, that the Monte Carlo calculation has to be done only once for a given detector and geometry. It implies an universal procedure for all materials. This program should be available to interested people within one year.

Coincidence summing

Gammaspectrometric measurements of low-level radioactivity are always done in a close source detector geometry. The largest solid angles, typically of the order of 98 to 99 % from 4π , are realized by measurements in a well-type detector. A consequence of the large solid angle is the presence of important coincidence summing effects for multi-photon emitting nuclides. Figure 1 shows for example the spectrum of ^{134}Cs measured in a well-type detector.

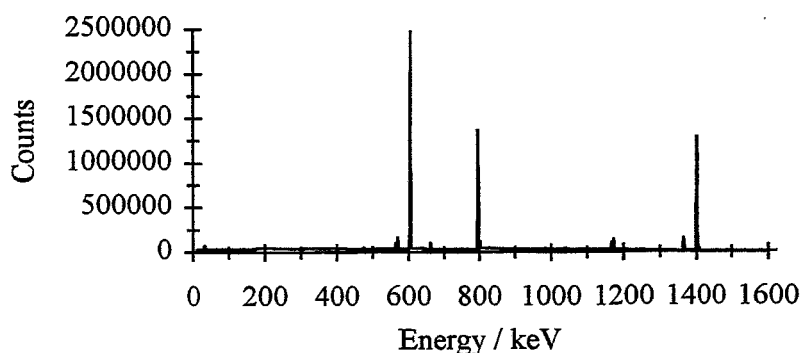

Figure 1: Spectrum of a ^{134}Cs standard solution in a plastic vial measured in a well-type detector for 1 day.

Besides the principal emission lines at 605 keV and 796 keV (with emission probabilities of 97.6 % and 85.4 % respectively), the sum peak at 1401 keV is clearly seen in the spectrum with a comparable peak height. Note that there is no ^{134}Cs emission line with this energy and that coincidence-summing is entirely responsible for this peak.

The important consequence of the coincidence-summing effect is, that for multi-photon emitting nuclides, the efficiency deviates from the efficiency curve obtained with single-photon emitting nuclides. To determine quantitatively the activity of such nuclides in the sample, nuclide specific calibrations should be used. But this experimental method is limited to the available standardized solutions. Another problem occurs if the degree of self-attenuation in the sample material is not negligible. Then the standardized solution has to be added to the sample to get a nuclide- and matrix-specific calibration.

Debertin et al. [10; 4] developed a computer program called KORSUM for the calculation of coincidence-summing corrections for cylindrical geometries. The necessary input data are the peak efficiency and total efficiency (which causes additional experimental work) for up to 30 energy points and nuclide-specific decay data. They also compare results of calculations using KORSUM as well as programs of different other authors [11].

In addition to the Monte Carlo programs for self-attenuation calculations of Sima [6-8] mentioned above, coincidence-summing corrections are also taken into account. The program calculates the coincidence-summing corrections (with respect to different self-attenuation in the calibration source and the sample matrix) for measurements with cylindrical containers or Marinelli beakers on coaxial- or planar-type detectors as well as for measurements with cylindrical containers inside of well-type detectors. We find a good agreement between experimental data and calculations even for very high corrections up to a factor of 10 (e.g. coincidence-summation of ^{134}Cs gamma-rays measured in a well-type detector as shown in Figure 1) [9]. This program is further developed. The large input data file containing nuclide-specific decay data used by KORSUM will be adapted to the Monte Carlo program.

References

- [1] Debertin K. and Helmer R.G. (1988) *Gamma- and X-ray Spectrometry with Semiconductor Detectors*. North Holland, Amsterdam.
- [2] Cutshall N.H., Larsen I.L. and Olsen R. (1983) Direct analysis of ^{210}Pb in sediment samples: self-absorption corrections. *Nucl. Instrum. Meth.* **206**, 309
- [3] Berger M.J. and Hubbell J.H. (1987) XCOM: Photon Cross Sections on a Personal Computer. *NBSIR* **87**, 3597.
- [4] Debertin K. and Ren J. (1989) Measurement of the activity of radioactive samples in Marinelli beakers. *Nucl. Instrum. Meth.* **A278**, 541.
- [5] Amersham (1995) Gamatool, self-absorption calculation software for gamma spectrometry systems *NIGB3059*.
- [6] Sima O. (1990) Monte Carlo simulation versus semiempirical calculation of autoabsorption factors for semiconductor detector calibration in complex geometries. *Prog. Nucl. Energy*, **24**, 327.
- [7] Sima O. (1996) Applications of the Monte Carlo calculations to gamma-spectrometric measurements of environmental samples. *To be published in Appl. Radiat. Isot.*
- [8] Sima O. (1996) Matrix effects in the activity measurements of environmental samples — implementation of specific corrections in a gamma-ray spectrometry analysis program. *To be published in Appl. Radiat. Isot.*
- [9] Sima O. and Arnold D. (1996) Self-attenuation and coincidence summing corrections calculated by Monte Carlo simulations for gamma-spectrometric measurements with well-type germanium detectors. *To be published in Appl. Radiat. Isot.*
- [10] Debertin K. and Schötzig U. (1979) Coincidence summing corrections in Ge(Li)-spectrometry at low-source to detector distances. *Nucl. Instrum. Meth.* **158**, 471.
- [11] Debertin K. and Schötzig U. (1990) *Bedeutung von Summationskorrekturen bei der Gammastrahlen-Spektrometrie mit Germaniumdetektoren*. PTB Report PTB-Ra-24.

QUALITY ASSURANCE IN THE ANALYSIS OF NATURAL RADIONUCLIDES - MEASURES AND RESULTS

Matthias Bothe

Nuclear Engineering and Analytics Rossendorf Inc. (VKTA), Germany

In the Laboratory for Environmental and Radionuclide Analytics we analyze several natural and also some artificial radionuclides in different materials. For the determination of radionuclides we use various analytical methods listed in the following table (table 1).

Table1: List of determined natural radionuclides and applied analytical methods
(D - directly, R - after radiochemical separation)

nuclide	γ -spectrom.	α -spectrom.	LSC / β -counting	emanometry	ICP-MS	XRF
U-238	-	R	-	-	D	D
Th-234	D	-	-	-	-	-
Pa-234m	D	-	-	-	-	-
U-234	D	R	-	-	D	-
Th-230	D	R	-	-	-	-
Ra-226	D, R	-	-	R	-	-
Rn-222	-	-	-	D	-	-
Pb-214/ Bi-214	D	-	-	-	-	-
Pb-210	D, R	-	R	-	-	-
Bi-210	-	-	R	-	-	-
Po-210	-	R	-	-	-	-
U-235	D	R	-	-	D	-
Pa-231	D	-	-	-	-	-
Ac-227	-	R	-	-	-	-
Th-227	D	R	-	-	-	-
Ra-223	D, R	-	-	-	-	-
Rn-219	D	-	-	-	-	-
Th-232	-	R	-	-	D	D
Ra-228	R	-	-	-	-	-
Ac-228	D	-	-	-	-	-
Th-228	-	R	-	-	-	-
Ra-224	R	-	-	-	-	-
Pb-212	D	-	-	-	-	-
Tl-208	D	-	-	-	-	-

This great variety of analytical methods allows us to pick out the appropriate for the analytical problem and to check the results with another method. Selection of the right analytical procedure depends on some factors:

- aim of investigation
 - is the sample below or above a given limit
 - nuclide ratios in some samples for the investigation of chemical processes
- desired precision
 - depends on the aim of investigation
- character of samples
 - different investigated sample types are listed in table 2
 - chemical processes in the sample material may caused radioactive disequilibrium
- number of samples
 - has an influence on time for sample treatment and counting
- sample amount
 - is an enrichment of radionuclides possible
 - is an division in subsamples for parallel determination of several nuclides possible
 - representative subsampling of large inhomogeneous samples
- allowed time
 - subsequent or parallel determination of several radionuclides
 - apply a "fast" or a "slow" method
- analytical costs
- free capacity of a method
 - number of detectors
 - available measuring time

Table 2: Sample materials

geological materials	liquids	biological materials	technical materials
rocks soil ore heap material fluvial sediments	ground water surface water mine water drainage water leaching solutions oil milk	grass wood vegetables fruits mushrooms fish meat	tailing scrap dust building materials products "yellow cake"

The main task of analytical quality assurance is to avoid mistakes during the analytical process, e.g.:

- disregarding of half-life-times
- disregarding of mother-daughter-relations
- disregarding of chemical and physical processes in the sample
- suspended matter in water samples
- nonselective radiochemical separation procedures
- insufficient chemical recovery
- formation of colloids (e.g. Pa-231)
- spectral interferences (e.g. X-ray-lines in gamma spectrometry)
- self absorption and matrix effects

To assure the analytical quality we take care to formal aspects like standard operation procedures and documentation of the whole analytical process. In addition to this we use the following measures:

- multiple analyses of samples
- analyses of the same sample by different methods
- application of radionuclide tracers
- analyses of standard reference materials
- comparison with other laboratories using real samples
- intercomparison runs organised by the Federal Agency of Radiation Protection and other agencies
- testing the plausibility of the results using whole knowledge of the sample (sample material, history, geology and geochemistry of the sampling site, possible chemical and physical processes in the sample etc.)

For new sample types the most powerful tool of quality assurance is the investigation of the sample with several methods based on different principles of sample preparation and/or measurement.

Our results of some intercomparison runs of different materials are shown in the figures 1 and 2.

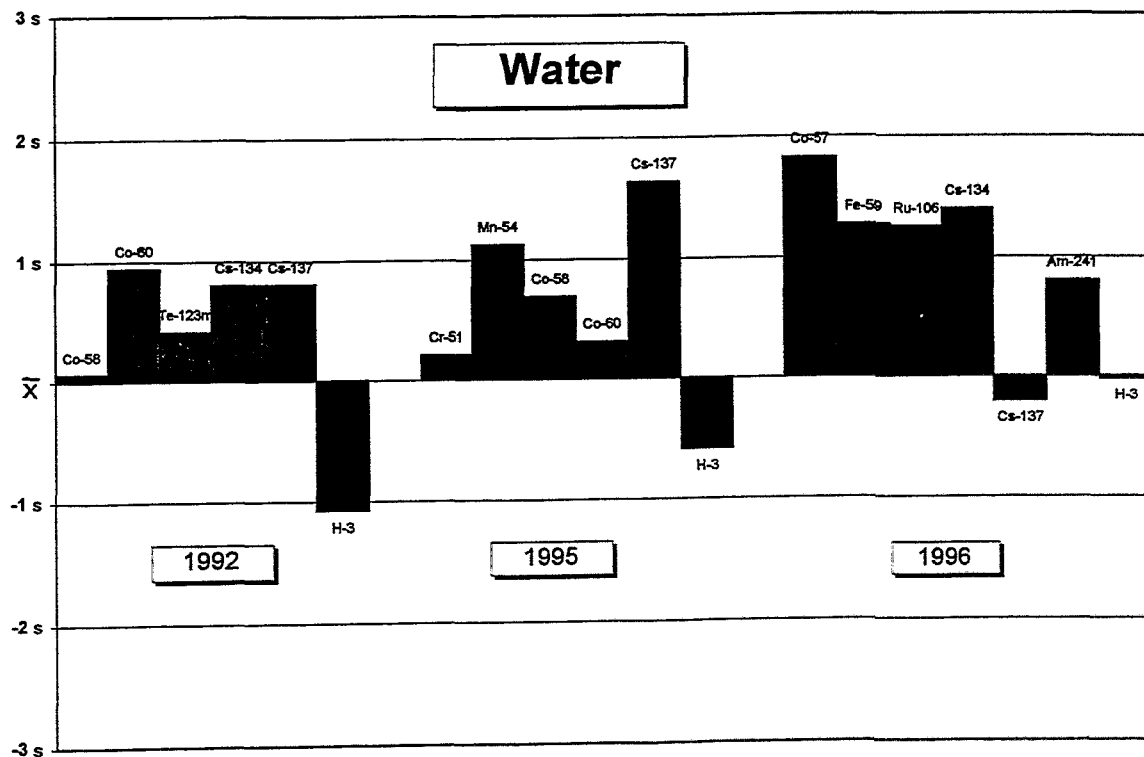

Figure 1: Intercomparison runs of water samples. Our results in relation to the average and standard deviation of all laboratories.

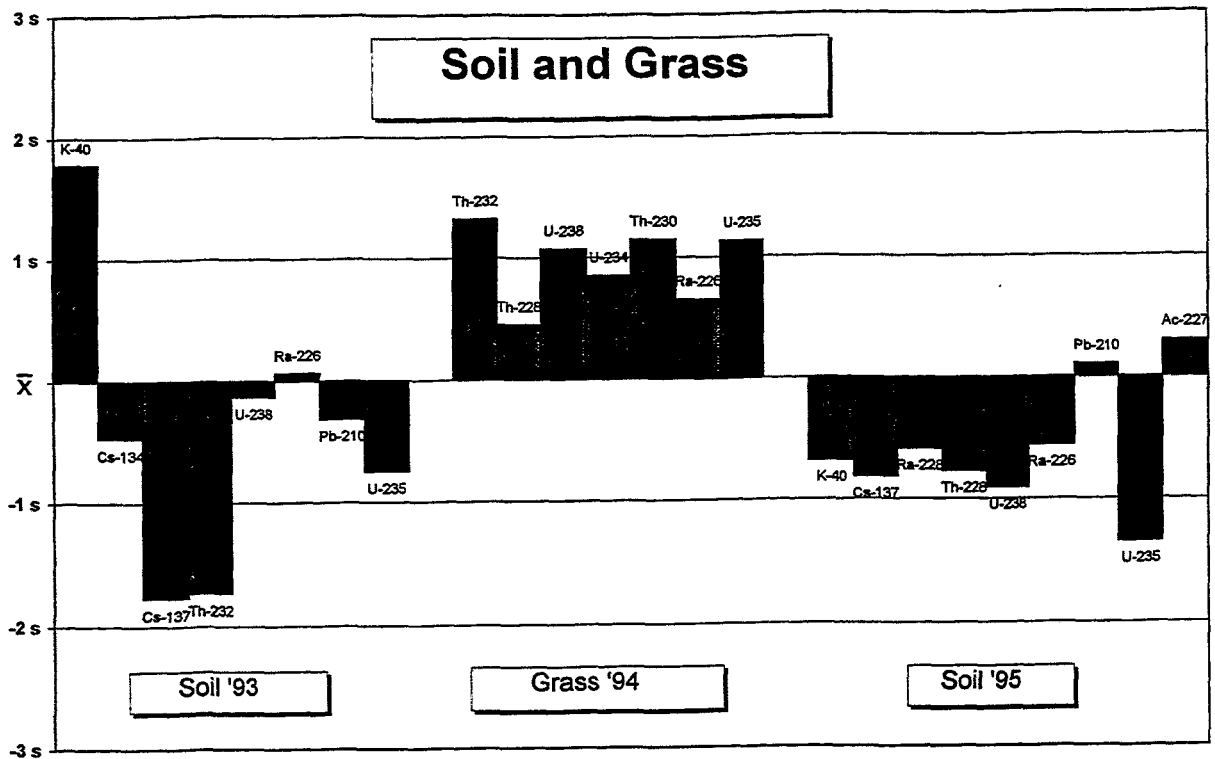

Figure 2: Intercomparison runs of soil and grass samples. Our results in relation to the average and standard deviation of all laboratories.

Since June 1996 the quality assurance system of the Laboratory for Environmental and Radionuclide Analytics is accredited by the German Accreditation System for Testing GmbH according to DIN EN 45.001.

Panel Discussion

The panel discussion was moderated by **Prof. H. Nitsche**, Forschungszentrum Rossendorf (FZR), Germany, and had the following participants:

Dr. A. Andradi	KFKI Atomic Energy Research Institute Budapest, Hungary
Prof. W. Görner	Bundesanstalt für Materialforschung und -prüfung (BAM), Germany
Dr. G. Heusser	Max-Planck-Institut für Kernphysik Heidelberg, Germany
Dr. D. Mouchel	CEC-JRC Institute for Reference Materials and Measurements, Belgium
Prof. B. F. Myasoedov	Vernadsky Institute of Geochemistry and Analytical Chemistry, Moscow, Russia
Prof. S. Niese	Verein für Kernverfahrenstechnik und Analytik Rossendorf (VKTA), Germany
Dr. P. Theodorsson	Science Institute, University of Iceland, Reykjavik, Iceland

Panel Discussion*

H. Nitsche: Ladies and gentlemen, at the beginning of this workshop I had placed the following topics as points for the panel discussion:

- What are the current research and technical areas that require low-level counting laboratories?
- Can the number of currently available facilities satisfy the demand?
- Is the collaboration between existing facilities satisfactory?
- Are there emerging technical challenges that may require low-level counting in the future?

As I have seen now, many of them have been answered during that workshop. The first one concerning the research and technical areas that require low-level counting laboratories has been answered. However, the research areas are very much described but not so the technical fields. Are there any technical areas that use low-level counting laboratories with the exception of counting the building materials of new counters? I would like to hand the microphone to the panel and I would like to have you, gentlemen, make some comments on these questions or come up with your own questions and what you would like to discuss here. I will just be the moderator here, and I would like to begin with the question of low-level counting in technical areas. What I really would like to have answered is: Where are we going? Are we just going to measure thousands of samples? Is this the purpose of an underground laboratory, or are there additional scientific and technical challenges for the future? Please Prof. Myasoedov.

B.F. Myasoedov: Thank you. I response to topic one. I believe that the most important papers of modern radiochemistry are dealing with the behaviour of radionuclides in nature. We get a lot of very interesting papers which show that some radionuclides have entered the biosphere, and we must know the behaviour of these radionuclides. I think that in this connection the possibilities of low-level laboratories are very important. But, as I mentioned in my talk, now we are not only interested in the total concentration of radionuclides. Especially, we need very good information about the form of their existence, because only on the base of knowledge about the form of existence we can predict the behaviour of radionuclides in the future. In that I believe that low-level laboratories must not only made so-called routine analysis, several hundred or thousand determinations, but must have a person to follow scientific interests about the behaviour of radionuclides in nature.

Another important source of information is the age determination by radionuclides. So carbon and tritium dating, using low level laboratories is quite necessary.

Nobody, unfortunately, mentioned one of the very dangerous nuclides, the long lived radio-iodine J-129.

G. Heusser: I have to apologize, because I mainly can speak only for basic research. Working in that field one observes, that the projects are always going to less and less frequent observations of event rates, so the event rates become always smaller and smaller. And this

*The transcript was slightly edited for clarity

means that most experiments are disturbed by the environmental radioactivity or any activity in our normal live. Radon is especially a very hard problem, and this makes it necessary to make a big search for materials selection or a big screening of different materials which have to be applied in these different experiments. They have to be measured for very low concentrations of different radionuclides. But what the technical application is concerned I could also think of some methods which use small activated materials like for corrosion measurements and also for engines, the use up of cylinder material. This all may be applications of low-level counting because you can observe the corrosions of very thin surfaces with such kind of very sensitive gamma spectroscopy, if you have applied before some activation or if you have implanted some activity into this material. For example, cobalt-60 is present in any modern steel and if you are able to measure this cobalt-60 activity at very low rates, then you are able to obtain information on the corrosion on steel, which is used in many applications.

W. Wahl (audience): I think we have to make investigations in the future to reduce the air activity, for example in the "Felsenkeller" or in other laboratories, to make them most suitable for incorporation measurements. This would be very helpful for example, to measure lead-210 in the body to recalculate the radon exposure from people working in mines and other work places with higher exposure.

G. Heusser: I think especially this medical application is also a very interesting topic for this kind of measurement and the use of low-level laboratories.

P. Theodórsson: Coming from a country, where geophysics is very important, it is, however, not the only source of my examples. But the importance of geophysics was demonstrated one month ago when an eruption, volcanic eruption, started in the middle of our largest glacier. Low-level counting has actually been used to date the magma chambers that are frequently having separated from deeper layers and are at a depth, so let us say, ten to twenty kilometers below the surface, and they can stay there for many years. The age of this magma chambers has actually been determined by the disparity or disequilibrium ratio of lead-210 from its mother radium isotope. This is something that I have only read about by my latest scientific working abroad. Another example what I can measure is, that it has been shown that it is in some areas at least possible to look at the radon concentration as a precursor for earthquakes, trying to predict when earthquakes come, because two or three weeks before an earthquake comes, there often appears an increase in the radon content of groundwater. We are now trying to improve the technique and design and construct a system, that can work automatically on-site instead of having to take samples every week and bringing them to the laboratory, which is very time consuming and does not give us samples that are frequent enough.

In radiocarbon dating the underground laboratory helps to date very old samples with greater precision. So that I think that generally we will see in the next few years a larger number of laboratories working underground.

F. Schönhofer: Well I will give some notes here and I would like to start not from the basic research, but more or less from the applied research or the application of measurement of radionuclides. There is one science which has to rely on low level counting, and this is radioecology. We have experienced after the Chernobyl accident when there was a lot of radionuclides available that radioecology started to bloom. Now the levels are very low and without low-level counting it is hardly possible to do any for the radioecological studies, of course in our areas in western Europe. It is necessary for tracer studies to use low-level

counting. When you, for instance, pour some tritiated water somewhere underground and you look where does it come out, so it is in order to make some hydrogeological investigations. You have to be able to measure very low concentrations, not to talk about the usual ways which you use for hydrogeological investigations using the spike which came in from the nuclear bomb explosions. Tracers can also be used, natural tracers for instance, to check the moving of air masses. Radon is one of these natural tracers and some other radionuclides have been used too. And they all are present in extremely low concentrations and have to be measured as accurate as possible.

For the practical point of view, low level counting or other counting with instruments of low background facilitates to measure radionuclides in a relatively short time and relatively accurate. This is also an economic question.

One part of this topic are the so-called dangerous radionuclides., I am not sure that everybody is aware of the fact that radium-226 is one of the most dangerous radionuclides. So the maximum permissible concentrations are extremely low, usually it is in the range of 0.1 Bq per liter drinking water for instance. To measure such low concentrations you have to rely on low-level counting of course. In excretion analysis where you have to check for instance occupationally exposed persons who work with plutonium etc. you measure the intake or you monitor the intake by measuring the excretion for plutonium. Again the levels you measure are extremely low, and without low-level counting you cannot follow this. And there is another, I would call it an economic question, which is very interesting. These ideas come from the USA. In the USA now it is hardly possible to get rid of any radioactive waste and it even goes so far, that it is hardly possible to get rid of any toxic solvents like salinos and so on. So one of the fields of low-level counting is actually also in clinical applications, where you reduce the amount of radionuclides used in clinical investigations. This is a very important and especially economic question. These are just some thoughts which I have on this topic. I think we can find many, many more.

H. Nitsche: I would like to proceed to the second point: Can the number of currently available facilities satisfy the demand? And I would like to find out from you: How many facilities do we have in Germany, it maybe possible that we missed one, how many are in Europe and how many are in Russia and the United States, worldwide. Who would like to start?

G. Heusser: There is "Felsenkeller", than we have a small low-level laboratory in Heidelberg, which is not maybe really a subterranean lab, than there is one at Asse which is maybe not so well known, but it is of high quality and in principle it could be used more than it has been done up to now. And well, than there was one in Freiberg, as far as I know at least with quite some shielding. I also would state that even a few meters of water equivalent are quite helpful, because with the sophisticated veto shield you would be able to get quite a good reduction in your background. Because than you are rid of the nucleonic component, with is not so easy to control, but myons are quite well to control. This is all what I can think of quite now, at least for Germany. In other countries they have much larger facilities like the Gran Sasso laboratory, a huge underground laboratory which can accomodate much more experiments or equipment than any of our laboratories here in Germany. And in France there is the "Modane", in Switzerland there is the "Mont Blanc" facility and, what else do we have, in Spain there is the "Confranc"-tunnel which is used for this purpose. In Monaco they are as far as I know setting up a system for marine environmental research, and, unfortunately I don't have my list here, but there are quite some more facilities, which are maybe not in my mind quite now.

W. Görner: I think we have enough of such installment but we could draw more benefit from them. Those we have should be furtherly developed, and such an application like the insertion of the whole body counter here in "Felsenkeller" I find a nice thing that opens quite a new possibility of use, and I am sure that this was not an optimum. One has simply inserted a current device into this possibility, but we have heard here a lot on sophisticated techniques. I am sure that our installation could be improved very much. And what I should like to say still is, with the help of the existing facilities we have learned, I personally have learned, a lot in this work, what gamma spectrometry is, and we can select and provide materials now, which give us in the future the possibility to make such facilities, like Dr. Theodórsson told us, in the cellar of an existing building. By the help of rather simple measurements or measures you can install in the future a minimum cost facility, if necessary.

H. Nitsche: Thank you. I would like to come back to the statement Dr. Schönhofer made, that many people were measuring radioactivity when the levels were high, but today the levels are lower because of decay. The question I like to ask, are these levels above or below the legal limits now?

F. Schönhofer: These values are now far below the legal limits with some exceptions like the famous mushrooms for instance. But usually everything is far below the legal limits and so counting is not necessary to establish, that the legal limits are kept.

H. Nitsche: Are there any medical applications then, because you mentioned that one would need more counting now. Medical type counting, surveying of population?

F. Schönhofer: No, this is a misunderstanding. That is not related to the Chernobyl accident. I was mentioning excretion analysis for persons working with radioactivity and also for the applications in clinical chemistry to reduce the amount of radionuclides. Using less activity also reduces the waste.

H. Nitsche: Of course it would be nice to have this analysis but it is also a matter of cost. The cost for a stool analysis was assessed to about 3.000 Marks, this number I think was mentioned yesterday, is this correct? Prof Niese, how much you charge for a stool analysis? And for a urine analysis? Let us say, a complete analysis including actinides.

M. Bothe (audience): I think, plutonium and uranium about 1.000 DM and the other actinides 500 DM.

H. Nitsche: O.K. So this is of course a tradeoff between cost and benefit and one has to be careful to make recommendations in this direction.

F. Schönhofer: Of course people working in nuclear reprocessing plants and so on, they have to be checked for intake. So this is not a question how much it will cost the company. The company has to do it. I have been recently in La-Hague and it is just normal routine, that everybody who comes in touch with plutonium has to deliver his urine to be analysed for actinides and for plutonium. Of course, I am not pleading to check the population for plutonium excretion. But may I add something which was already started with the question of the facilities. Of course when it is the question of germanium detectors than underground laboratories have an extremely big benefit. But a low-level laboratory does not necessary have to go underground.

For instance in my counters the so and so many hundred meters of water equivalent are replaced by the active shielding. And also we should think of the alpha spectrometry, where movement to an underground laboratory in my opinion will not change anything on the background.

So to respond to the questions I will answer for my country. I regard my laboratory as a low-level counting laboratory. But for instance for alpha spectrometry, we have people at Seibersdorf, Research Center Seibersdorf, who perform this analysis for us.

P. Theodórsson: Well, we can go underground to obtain lower background, but there is another method of course that has been described here, that is by using external guard counters which is now a speciality. I think, that if we can design very simple and inexpensive external guard counters their use will be much more common. They can give us a factor of five in the decrease of background, even more, when we are working in shallow underground laboratories.

H. Nitsche: Thank you. This brings me to one question that was handed to me from the audience: Can you recommend numbers and/or figures that describe low level systems in order to compare them with other systems? Who would like to answer this question?

H. Theodórsson: I don't know, whether my answer is direct, but I have done a lot of work comparing systems, and that is made much more difficult than it needed to be, because there are so much great differences how the people are reporting their systems. If we could standardize the reporting, let us name one thing, the overburden, with is of course very important. It is very seldom that the overburden is specified to any extend. And also, when we see background spectra, they are often given simply in counts per channel whereas we should give them in counts per keV per hour or some other time unit. I think that it would help us very much in comparing our systems, if we had a more uniform way of describing a system.

D. Mouchel: Perhaps a way to characterize detection systems very well is to bring a maximum of information for example on the various radiation fluxes in the place where the measurements are performed. If you look for the exposure rate, the radon concentration, the muons, fast and gamma neutrons, and if you bring the specifications of the materials, which are used to build the shielding, you have all the information to reduce something, for example how many counts are generated per kilogram. It seems to me very important to characterize each place according to the radiation fluxes and the materials.

H. Nitsche: Should there be a guideline issued, to report these things?

G. Heusser: For germanium spectroscopy there is a figure of merit for example, which gives us the quality; where you can draw a line, which is low-level and which is not low-level. It is also to point out that there is already a DIN specification on systems for gamma spectroscopy, germanium spectroscopy, with is already pointing to this line. So there are already some measures which will have only to be applied, and I am sure they are available for each detector.

P. Theodórsson: A remark on a guideline: Yes, I think that it would be very useful, and actually in my book, that will come in two months, such successions are given, how we should report it. And yes one remark: When the background of the germanium systems is given, I think I have seen figures for the total background in this workshop from 15 to 1500 keV, from 100 to 2000 or 700 keV, and some other windows. This is just an example, that we should specify some windows, so that we get an uniform issue.

H. Nitsche: Thank you. This touches a little bit on the next point where we asked: Is the collaboration between existing facilities satisfactory, or can an increased exchange of informations strengthen the field. Who would like to commend on that?

Dr. Mouchel: I think, it is very important to have a maximum exchange between the different low-level counting system underground facilities, for example for the low activity materials. When I started I was endeavoured to look on the left, on the right to try to inform myself, what company is able to provide the lead, the copper, or I phoned to some colleague. I am sure that this is very positive, very helpful, when we can communicate about some data, some specifications, where we can find suitable materials, and so on.

W. Görner: For my taste this answer was too specific, because only a very few people are interested in this low activity lead and all these technical details. Our problem is, on the other side, to make clear what we can do with our facilities, and the interlinks between low-level laboratories and researchers or metrologists at other points have to be connected. It is our task to make public relations for these possibilities. And this workshop is perhaps a part of this. But we are all insiders, we have to go outside.

D. Mouchel: Just a remark on the remark. We are an institute for reference materials and measurements, and my preceding remark refers to a very interesting field especially at the very low level. I believe an underground facility can be an field of excellence, and for the certification of materials we need some excellent qualification. And in this field of material certification we are obliged.

H. Nitsche: Thank you for your comment. You come from the European institute in Geel, the Institute for Reference Materials and Measurements. This European institute would be a perfect organisation to work together with all these other European laboratories and to take the lead in setting the standards, setting the things that we are just discussing.

D. Mouchel: Probably we are ready to take the leader position but probably the other countries will not agree to this.

H. Nitsche: It does not have to be a lead where everybody has to follow, but to issue guidelines in accordance with the other laboratories, for example for the standardization of the reporting. Having a workshop on this topic, I think, this would be a perfect issue for European run laboratories. Since most of us here are from European countries and these laboratories are in Europe, this would be a very nice example that Europe is working together scientifically. Would you take this home to your management and discuss it?

D. Arnold (audience): Maybe a short comment. Of course there are close connections between the European reference laboratory and our national standard laboratory, also in the low-level radioactivity field. There are more and more cooperations and projects running.

H. Nitsche: As I said in the beginning, I will play devil's advocate.

A. András: I just would like to underline what was mentioned. When we are talking about cooperation than we can also think about the intercomparison exercises, intercalibrations and something like that. And as it is well-known maybe for everybody of you, the IAEA has a

quality assurance program, and so the agency is also distributing low-activity materials for measurements. This kind of intercomparison exercises is organized in different fields. Maybe it is a little bit different aspect from what was discussed here in these days. The in-situ gamma spectrometry comprises measurements where we are not using any shielding around the detector. The detector is put in the environment and we try to measure the activity of natural and man-made radionuclides. It is also in the direction of low-activity measurements, and in this field we have a very good cooperation with this central European region.

H. Nitsche: Thank you, Dr. András. What I was wishing was something a little less formal, but with some formalism. That people who sit here can talk to each other, if they use the same reporting of data. This does not require a big elaborated mechanism. The experts here usually can compare each other measurements. But other people would like to see which laboratory seems to be better for certain radionuclide measurements than other laboratories.

A. András: What in-situ gamma spectrometry is concerned, this is the way what we are following for many years. Every year we are coming together in a workshop, very informal conditions, and we learn from each other, and this is the practice.

W. Wahl: For my feeling this is more a basis for formal administered cooperation, so I miss the points or aspects for bilateral cooperations. They are more stimulating or more efficient for projects. I have an example for this. I realized the problem, perhaps a problem for people working in the underground laboratories, of asymmetric peaks in the spectra caused by irradiating germanium detectors with neutrons for example. In these spectra you see normal peaks from photons or escapes and also asymmetric peaks from an inelastic neutron scattering. So I think, this would be a good example to start a cooperation or to stimulate a cooperation with people analyzing the neutron interaction in underground laboratories. We measured this with a tritium target in the proton beam, and we also modelled the germanium detector, and we simulated this to have informations about the range of the incidental neutron energy. So our idea was to recalculate this incidental range of neutron energy from the shape of the asymmetric peak. Perhaps this is an active stimulation for a cooperation and perhaps it is of interest for you.

S. Niese: I think we have much possibilities to cooperate with scientific institutes to solve some problems in the field of oceanologie, in the field of geochemistry, but the main question in the first stage was: What are the possibilities we have to measure low radioactivity in technical products? And formerly we had to measure radionuclides or trace elements in silicon and also alpha emitters in silicon wafers and other materials which are used in semiconductor containing devices, especially memories, to investigate the so-called soft error problem. When I remember the experiences that we have got during these projects, I think also such techniques can be improved using a lower background of neutrons and other emitters. I think we can have discussions in the future with the large semiconductor producing factories which started their work now in the region of Dresden.

Another general remark: Usually lead is used above ground for shielding. And from which places does the radioactivity come, mainly from the building itself. For measuring low-level radioactivities, however, you can construct the building from materials with lower radioactivity. You can look for cements, you can use a synthetic cement, you can look for special materials containing less radioactivity. And if the building is made of low-radioactivity materials, you do not need such a thick lead shield, and if you have a smaller shield, you do not have so much neutrons. I think this is also a way what we can think about.

I will take the opportunity to say, that we have a longstanding cooperation with the Heidelberg laboratory, with Dr. Heusser. We were together at the beginning of our projekt, and we have collected many experiences from him and also from other deep underground facilities. And so I think that the collaboration between people which are measuring low radioactivities will continue also in the future. The proposal concerning the investigation of the asymmetric pulse is only one important thing what we can do with low counting rates.

W. Görner: I want to make still a comment especially to you, Prof. Nitsche. You told us, that you are not an insider here, but what you are, this is, you are a teacher, and I think your questions, your challenges where very nice. One of the challenges is, according to my opinion, education. We can do here, as I may say, "non-activity" radiometry. Non-activity in parentheses, and we can work well below the legal licence levels. We can carry out experiments in our flats or in the highschool with students perfectly without any danger, if we have such measurement devices, which are able to measure very small activities, and so you can also measure dynamics in this field without reaching the legal levels. This is the a benefit of such devices, especially in a university town, which should not be neglected.

Dr. Petri (audience): I am working in a small radioanalytical group in Jülich, Research Center Jülich, and we do not have a lack of instruments but we have a lack of personal. Persons who operate this instruments, that is the problem.

H. Nitsche: We need more people to be educated in radiochemistry. I agree with you, could not agree more. - Now, I would like to get one last comment from the panel.

B.F. Myasoedov: I just remember, that two years ago the radiochemical division of the International Union of Pure and Applied Chemistry (IUPAC) has published a technical report about the determination of very low levels of radioactivity. This report should be available from IUPAC.

H. Nitsche: At the end of this panel discussion and our workshop, I would like to thank all speakers and all participants for coming here and for preparing their talks. I would like to thank the chair people for doing such a fine job and keeping us nearly on time, and the panel for, I think, interesting comments and discussions. I also would like to thank especially Dr. Fietz, who is the conference secretary. Without him we would not have been able to hold this conference. Thanks also to his assistant Ms. Scheere and the two ladies from my institute, Mrs. Müller and Mrs. Fröhlich, who managed the coffee service.
I thank you all for coming, and I hope that we see us again, maybe in two years here. I wish you a safe trip home. Thank you very much.

List of Participants

List of Participants

- | | | |
|---------------------------|---|--|
| ANDRÁSI Andor | KFKI Atomic Energy Research Institute
P.O.Box 49
H-1525 Budapest
HUNGARY | Tel.: +36 1 395 92 20/ 91 50
Fax: +36 1 395 92 93
E-mail: andrasi@sunserv.kfki.hu |
| ARNOLD Dirk | Physikalisch-Technische Bundesanstalt
Bundesallee 100
38116 Braunschweig
GERMANY | Tel.: +49 531 592 6332
Fax: +49 531 592 6015
E-mail: dirk.arnold@PTB.de |
| BEETZ Joachim | Landesumweltamt Brandenburg
Meßstelle Neuendorf am See
15910 Neuendorf am See
GERMANY | Tel.: +49 35473 622
Fax: +49 35473 408
E-mail: |
| BERNHARD Gert | Forschungszentrum Rossendorf
Postfach 51 01 19
01314 Dresden
GERMANY | Tel.: +49 351 260 3280
Fax: +49 351 260 3553
E-mail: G.Bernhard@fz-rossendorf.de |
| BEUTMANN Andreas | Verein für Kernverfahrenstechnik
und Analytik
Postfach 51 01 19
01314 Dresden
GERMANY | Tel.: +49 351 260 3448
Fax: +49 351 260 3551
E-mail: A.Beutmann@fz-rossendorf.de |
| BOTHE Matthias | Verein für Kernverfahrenstechnik
und Analytik e. V.
Postfach 51 01 19
01314 Dresden
GERMANY | Tel.: +49 051 260 3367
Fax: +49 351 260 3190
E-mail: M.Bothe@fz-rossendorf.de |
| BRÜCKNER Christian | Forschungszentrum Karlsruhe
Projekträger des BMBF für Entsorgung
Postfach 36 40
76021 Karlsruhe
GERMANY | Tel.: +49 7247 82 5795
Fax: +49 7247 82 5796
E-mail:
christian.brueckner@pte.fzk.de |
| CEUPPENS Michel | Canberra Semiconductor
Lammerdries 25
B-2250 Geel
BELGIUM | Tel.: +32 1422 1975
Fax: +32 1422 1991
E-mail: mceuppens@canberra.com |
| DÄRR Lothar | C&E Consulting und
Engineering GmbH
Postfach 62
09034 Chemnitz
GERMANY | Tel.: +49 371 88 7653
Fax: +49 371 88 2642
E-mail: |

DEGERING Detlev	Technische Universität Bergakademie Freiberg Institut für angewandte Physik Bernhard-von Cotta-Str. 4 09559 Freiberg GERMANY	Tel.: +49 3731 39 2595 Fax: +49 3731 39 4004 E-mail: degering@theo2.physik.tu-freiberg.de
DIETRICH Jörg	Landesumweltamt Brandenburg Meßstelle Neuendorf am See 15910 Neuendorf am See GERMANY	Tel.: +49 35473 622 Fax: +49 35473 408 E-mail:
FIETZ Jürgen	Forschungszentrum Rossendorf e. V. Postfach 51 01 19 01314 Dresden GERMANY	Tel.: +49 351 260 2287 Fax: +49 351 260 3651 E-mail: J.Fietz@fz-rossendorf.de
FUNSCH Benno	Landesanstalt für Umweltschutz Baden-Württemberg Abteilung 3 Postfach 21 07 52 76157 Karlsruhe GERMANY	Tel.: +49 721 983 2224 Fax: +49 721 983 2339 E-mail:
GEIPEL Gerhard	Forschungszentrum Rossendorf e. V. Postfach 51 01 19 01314 Dresden GERMANY	Tel.: +49 351 260 2306 / 3168 Fax: +49 351 260 3553 E-mail: G.Geipel@fz-rossendorf.de
GLEISBERG Birgit	Verein für Kernverfahrenstechnik und Analytik e. V. Postfach 51 01 19 01314 Dresden GERMANY	Tel.: +49 351 260 3176 / 3643 Fax: +49 351 260 3190 E-mail: B.Gleisberg@fz-rossendorf.de
GÖRNER Wolf	Bundesanstalt für Materialprüfung Unter den Eichen 87 12205 Berlin GERMANY	Tel.: +49 30 8104 1140 Fax: +49 30 8104 1147 E-mail: annemarie.rosner@bam-berlin.de
GOLLNEST Hans Joachim	Wallac-ADL-Außendienstbüro Wilhelm-Liebknecht-Straße 30 A 16341 Zepernik GERMANY	Tel.: +49 30 9441 4611 Fax: +49 30 9441 4613 E-mail:
HECK Bernhard	EG + G ORTEC GmbH Hohenlindener Str. 12 81677 München GERMANY	Tel.: +49 89 926 92 300 Fax: +49 89 913 717 E-mail: Bernd_Heck@EGGINC.COM
HELBIG Wolfgang	Verein für Kernverfahrenstechnik und Analytik e. V. Postfach 51 01 19 01314 Dresden GERMANY	Tel.: +49 351 260 3176 Fax: +49 351 260 3190 E-mail:

HEUSSER Gerd	Max-Planck-Institut für Kernphysik Postfach 10 39 80 69029 Heidelberg GERMANY	Tel.: +49 6221 516 238 Fax: +49 6221 516 540 E-mail: HEUSSER@KOSMO.MPI-HD.MPG.DE
HINTZ Helge	Wallac-ADL-GmbH Jechtinger Straße 9 69111 Freiburg GERMANY	Tel.: +49 76145549 70 Fax: +49 761 45549 13 E-mail: helge_hintz@egginc.com
HÜFNER Reinhold	Forschungszentrum Karlsruhe GmbH Projekträger Entsorgung Postfach 36 40 76021 Karlsruhe GERMANY	Tel: +49 7247 82 3590 Fax: +49 7247 82 5796 E-mail: reinhold.huefner@pte.fzk.de
JANSTA Vladimir	International Atomic Energy Association IAEA Safeguards Analytical Laboratory A-2444 Seibersdorf AUSTRIA	Tel.: +431 2060 28562 Fax: +432 2547 39515 77 E-mail: jansta@riall.iaea.or.at
JANTSCH Karl	Verein für Kernverfahrenstechnik und Analytik e. V. Postfach 51 01 19 01314 Dresden GERMANY	Tel.: +49 351 260 3220 / 3692 Fax: +49 351 260 3179 E-mail: K.Jantsch@fz-rossendorf.de
KAIHOLA Lauri	Wallac Oy P.O.Box 10 Fin-20101 Turku FINLAND	Tel.: +358 2 267 8111 Fax: +358 2 267 8332 E-mail: lkai@mail.wallac.fi
KNOBUS Bernd	Staatliche Umweltbetriebsgesellschaft (UBG) Wasastr. 50 01445 Radebeul GERMANY	Tel.: +49 351 8312 633 Fax: +49 351 8312 623 E-mail:
KÖHLER Mathias	Verein für Kernverfahrenstechnik und Analytik e. V. Postfach 51 01 19 01314 Dresden GERMANY	Tel.: +49 351 4184 352 Fax: +49 351 4184 353 E-mail: M.Koehler@fz-rossendorf.de
KOPKA Bernd	Isotopenlaboratorium für biologische und medizinische Forschung der Universität Göttingen Burckhardtweg 2 37077 Göttingen GERMANY	Tel.: +49 551 398 115 Fax: +49 551 398 110 E-mail: bkopka@gwdg.de
LÖBNER Walfried	Wismut GmbH Jagdschänkenstraße 29 09117 Chemnitz GERMANY	Tel.: +49 371 8120 127 Fax: +49 371 8120 107 E-mail

MANN Gunnar	TU Dresden Institut für Strahlenschutzphysik Mommсенstr. 13 01069 Dresden GERMANY	Tel.: +49 351 463 2566 Fax: +49 351 463 7040 E-mail:
MOUCHEL Daniel	CEC-JRC, Institut for Reference Materials and Measurements (IRMM) Retieseweg B-2440 Geel BELGIUM	Tel.: +32 14 571 267 Fax: +32 14 584 273 E-mail: mouchel@linac0.irmm.jrc.be
MÜLLER Wolfgang	Laboratorium Prof. Dr. Berthold GmbH & Co. KG Calmbacher Str. 22 75323 Bad Wildbach GERMANY	Tel.: +49 30 64903917 Fax: +49 30 64903918 E-mail:
MYASOEDOV Boris	V. I. Vernadski Institute for Geochemistry and Analytical Chemistry Kosygin ul. 19 117975 Moscow RUSSIA	Tel.: +7 095 137 4147 Fax: +7 095 938 2054 E-mail: bfm@geokhi.msk.su
NEBELUNG Cordula	Forschungszentrum Rossendorf e. V. Postfach 51 01 19 01314 Dresden GERMANY	Tel.: +49 351 260 3136 / 2302 Fax: +49 351 260 3553 E-mail: C.Nebelung@fz-rossendorf.de
NIESE Siegfried	Verein für Kernverfahrenstechnik und Analytik e. V. Postfach 51 01 19 01314 Dresden GERMANY	Tel.: +49 351 260 2098 Fax: +49 351 260 3190 E-mail: S.Niese@fz-rossendorf.de
NITSCHHE Heino	Forschungszentrum Rossendorf e. V. Postfach 51 01 19 01314 Dresden GERMANY	Tel.: +49 351 260 3210 / 3233 Fax: +49 351 260 3553 E-mail: H.Nitsche@fz-rossendorf.de
NITZSCHE Olaf	Bergakademie Freiberg Bernhard-von-Cotta-Str. 4 09599 Freiberg GERMANY	Tel.: +49 3731 39 2771 Fax: +19 3731 39 4004 E-mail: nitzsche@physik.tu-freiberg.de
OEHLING Otmar	Eurisys Meßtechnik GmbH Nahestraße 2 - 4 55118 Mainz GERMANY	Tel.: +49 6131 960 990 Fax: +49 6131 960 994 E-mail:
PETRI Hermann	Forschungszentrum Jülich GmbH Zentralabteilung für Chemische Analysen 52425 Jülich GERMANY	Tel.: +49 2461 61 6760 / 4664 Fax: +49 2461 61 3263 E-mail: h.petri@kfa-juelich.de
PITTERICH Horst	Forschungszentrum Karlsruhe Projekträgerchaft Entsorgung Postfach 36 40 76021 Karlsruhe GERMANY	Tel.: +49 7247 82 4844 Fax: +49 7247 82 5796 E-mail: horst.pitterich@pte.fzk.de

PREUSSE Werner	I. N. F. N. - Gran Sasso Laboratories I-67010 Assergi (AQ) ITALY	Tel.: +39 862 437 278 / 379 Fax: +39 862 437 570 E-mail: preusse@lngs.iufn.it
PROKERT Konrad	TU Dresden Institut für Strahlenschutzphysik Mommсенstr. 13 01069 Dresden GERMANY	Tel.: +49 351 463 2978 Fax: +49 351 469 7040 E-mail: prokert@pss+s1.phy.tu-dresden.de
REGNER Jens	Wismut GmbH Jagdschänkenstraße 29 09117 Chemnitz GERMANY	Tel.: +49 371 8120 159 Fax: +49 371 8120 107 E-mail:
RIEDEL Christina	Institut für anorganische Chemie Währingerstr. 42 A-1090 Wien AUSTRIA	Tel.: +431 313 672068 Fax: +431 313 672040 E-mail: a8501161@unet.univie.ac.at
SAHRE Peter	Verein für Kernverfahrenstechnik und Analytik e. V. Postfach 51 01 19 01314 Dresden GERMANY	Tel.: +49 351 260 3695 / 3499 Fax: +49 351 260 3497 E-mail: P.Sahre@fz-rossendorf.de
SCHÄFER Ingrid	Verein für Kernverfahrenstechnik und Analytik e. V. Postfach 51 01 19 01314 Dresden GERMANY	Tel.: +49 351 260 2124 Fax: +49 351 260 3190 E-mail: I.Schaefer@fz-rossendorf.de
SCHLEICH Nanette	Institut für angewandte Physik Bergakademie Freiberg Bernhard-von-Cotta-Str. 4 09599 Freiberg GERMANY	Tel.: +49 3731 39 2163 Fax: +49 3731 39 4004 E-mail: schleich@physik.tu-freiberg.de
SCHÖNFELD Eckart	Physikalisch-Technische Bundesanstalt Bundesallee 100 38116 Braunschweig GERMANY	Tel.: +49 531 592 6330 Fax: +49 531 592 6015 E-mail: eckhart.schoenfeld@PTB.de
SCHÖNHOFER Franz	Bundesanstalt für Lebensmittel- untersuchung u. -forschung Kinderspitalgasse 15 A-1095 Wien AUSTRIA	Tel.: +43 1 40491 520 Fax: +43 1 40491 540 E-mail: schoenho@via.at
SCHUPFNER Robert	Universität Regensburg Fakultät Chemie / Pharmazie Universitätsstraße 31 93040 Regensburg GERMANY	Tel.: +49 941 943 4939 Fax: +49 941 943 4505 E-mail: robert.schupfner@chemie.uni-regensburg.de
SILVA Robert J.	California State University San Jose Chemistry Department San Jose CA 95192-0101 U. S. A.	Tel.: +1510 831 0732 Fax: +1 510 838 4491 E-mail: rjsil@aol.com

SUDARTI Siswobartoyo	Nuclear Research Center Yl. Barkasoni P.O.Box 1008 Yogyakarta INDONESIA	Tel.: +49 2461 61 5346 Fax: +49 2461 61 5346 E-mail:
THEODORSSON Pall	Science Institute University of Iceland Dunhaga 3 107 Reykjavik ICELAND	Tel.: +354 525 4800 Fax: +354 552 8911 E-mail: pth@raunvis.hi.is
UHLMANN Gerd	Sächsisches Ministerium für Wissenschaft und Kunst Postfach 10 09 20 01067 Dresden GERMANY	Tel.: +49 351 564 6410 Fax: +49 351 564 6400 E-mail: ul@smwk.lsn.dbp.de
UNTERRICKER Sepp	Bergakademie Freiberg Bernhard-von-Cotta-Ctr. 4 09599 Freiberg GERMANY	Tel.: +49 3731 39 2593 Fax: +49 3731 39 4004 E-mail: untterr@tu-freiberg.de
WAGNER Günther	Canberra-Packard GmbH Robert-Bosch-Str. 32 63303 Dreieich GERMANY	Tel.: +49 6103 38 50 Fax: +49 6103 38 5188 E-mail:
WAHL Wolfgang	GSF - Forschungszentrum für Umwelt und Gesundheit GmbH Institut für Strahlenschutz Ingolstädter Landstr. 1 85758 Oberschleißheim GERMANY	Tel.: +49 89 3187 2348 Fax: +49 89 3187 3373 E-mail: wahl@gsf.de
WALLNER Gabriele	Institut für anorganische Chemie Währingerstr. 42 A-1090 Wien AUSTRIA	Tel.: +43 1 31367 2015 Fax: +43 1 31367 2040 E-mail: wallnerg@pap.univie.ac.at
WILHELM Christoph	Forschungszentrum Karlsruhe GmbH Technik und Umwelt Hauptabteilung Sicherheit Abteilung Umweltschutz Postfach 36 40 76021 Karlsruhe GERMANY	Tel.: +49 7247 82 2784 Fax: +49 7247 3854 E-mail: christoph.wilhelm@hs.fzk.de