

Uncertainty analysis of gamma-ray densitometry applied for gas flow modulation technique in bubble columns

Marchini, S.; Bieberle, A.; Schubert, M.; Hampel, U.;

Originally published:

August 2023

Chemical Engineering Science 282(2023), 119214

DOI: <https://doi.org/10.1016/j.ces.2023.119214>

Perma-Link to Publication Repository of HZDR:

<https://www.hzdr.de/publications/Publ-35793>

Release of the secondary publication
on the basis of the German Copyright Law § 38 Section 4.

CC BY-NC-ND

Measuring the gas phase dispersion coefficient in bubble columns with the gas flow modulation technique and gamma-ray densitometry: An uncertainty analysis

Sara Marchini^{a,b*}, André Bieberle^b, Markus Schubert^{b,c*}, Uwe Hampel^{a,b}

^aChair of Imaging Techniques in Energy and Process Engineering, Technische Universität
Dresden, 01062 Dresden, Germany

^bInstitute of Fluid Dynamics, Helmholtz-Zentrum Dresden-Rossendorf, Bautzner Landstraße
400, 01328 Dresden, Germany

^cChair of Chemical Engineering, Technische Universität Dresden, 01062 Dresden, Germany

*Corresponding author: s.marchini@tu-dresden.de (S. Marchini)

Abstract

The gas flow modulation technique is a recently proposed approach for measuring the axial gas dispersion coefficient in bubble columns and potentially in other gas-liquid contactors. This study presents a quantitative analysis of the experimental uncertainty that is associated with gamma-ray densitometry and ensemble-averaging of the data. The considered uncertainty sources are the statistics of the photon counting process, a mismatch between the modelled and the real radiation propagation due to the spatial extent of the detector, and a potential mismatch between modulation and sampling frequencies. The analysis is based on a numerical gamma-radiation propagation model and a Monte Carlo approach to account for statistical uncertainty. The proposed algorithm supports the selection of an optimal total scanning time based on detector size, modulation parameters, involved fluids as well as column and source parameters. The analysis reveals that a mismatch between the modulation and sampling frequencies is most critical while the impact of the other considered uncertainty sources is rather marginal.

28 **Keywords**

29 Gas flow modulation technique, axial dispersion coefficient, gamma-ray densitometry,
30 uncertainty analysis

31

32 **1. Introduction**

33 Hydrodynamics and mass transfer in gas-liquid contactors are most commonly modelled with the
34 one-dimensional axial dispersion model (ADM). It describes the spatiotemporal concentration of
35 a species in the liquid or gas phase via the convection-diffusion equation

$$\frac{\partial c}{\partial t} = D \frac{\partial^2 c}{\partial z^2} - u \frac{\partial c}{\partial z}. \quad 1$$

36 Here, c is the concentration of a species in the considered phase, u is the superficial velocity of the
37 considered phase and D is the axial dispersion coefficient. A reliable quantification of the axial
38 liquid and gas dispersion coefficients in gas-liquid contactors is crucial for their design and
39 performance assessment. Recently, Hampel [1] proposed the gas flow modulation (GFM)
40 technique for the non-invasive measurement of the axial gas dispersion coefficient in bubble
41 columns, which is potentially applicable to other gas-liquid contactors as well. Contrary to the
42 traditional approaches based on tracer substances (e.g., [2, 3]), the GFM technique uses a marginal
43 sinusoidal disturbance superimposed on the gas inlet flow rate as virtual tracer. This disturbance
44 introduces a sinusoidal variation of the gas holdup in time, further on referred to as gas holdup
45 wave. Due to the gas dispersion, the gas holdup wave is damped in amplitude and shifted in phase
46 along the column. Mathematically, this can be described in the following way. Assume that the gas
47 flow at the inlet has a constant flow rate plus a marginal sinusoidal change in time. This will
48 produce a modulated gas holdup in the column. Now we consider only the sinusoidal part ϵ' of the
49 gas holdup. At the inlet we may assume it to be of unit strength and zero phase shift, that is
50 $\epsilon'(z = 0, t) = \cos(\omega t)$. Further up the column at a position $z > 0$ we find $\epsilon'(z > 0, t) =$

51 $V(z) \cos(\omega t + \Delta\phi(z))$. That is, the gas holdup wave is damped in amplitude (V) and shifted in
 52 phase ($\Delta\phi$).

53 The one-dimensional axial dispersion model for the gas holdup is given in the time domain as

$$\frac{\partial \epsilon(z, t)}{\partial t} = D_G \frac{\partial^2 \epsilon(z, t)}{\partial z^2} - u_G^* \frac{\partial \epsilon(z, t)}{\partial z}, \quad 2$$

54 and in the frequency domain as

$$j\omega E(z, \omega) = D_G \frac{\partial^2 E(z, \omega)}{\partial z^2} - u_G^* \frac{\partial E(z, \omega)}{\partial z}, \quad 3$$

55 where z is the axial distance from the gas sparger, D_G is the axial gas dispersion coefficient, u_G^* is
 56 the average bubble rise velocity, $\omega = 2\pi f$ is the modulation frequency and E is the time-domain
 57 Fourier transform of the axial gas holdup distribution. Solving Equation 3 analytically one can
 58 derive the following expressions for V and $\Delta\phi$ between two axial planes with distance Δz [1]:

$$V = \exp\left(\frac{u_G^*}{2D_G} \left[1 - \frac{1}{\sqrt{2}} \sqrt{1 + \sqrt{1 + \frac{16\omega^2 D_G^2}{u_G^{*4}}}}\right] \Delta z\right), \quad 4$$

$$\Delta\phi = -\frac{u_G^*}{D_G \sqrt{8}} \left[\sqrt{\left[\sqrt{1 + \frac{16\omega^2 D_G^2}{u_G^{*4}}} \right] - 1} \right] \Delta z. \quad 5$$

59 Both equations are needed for determining the axial gas dispersion coefficient. In fact, the limited
 60 sensitivity of Equation 5 to a change in D_G does not allow reliable calculation of D_G , as shown by
 61 Marchini et al. [4]. In addition, multiple solutions to Equation 4 in terms of D_G exist in at least part
 62 of the domain. In order to use Equations 4 and 5 for calculating D_G the values of the amplitude and
 63 phase of the gas holdup wave must be measured at least at two axial positions in the column. This
 64 was first demonstrated by Döbß et al. [5] using gamma-ray densitometry as illustrated in the
 65 simplified scheme in **Figure 1a**.

66 Recently, Marchini et al. [4] introduced a theoretical analysis and quantification of the inherent
 67 uncertainty caused by the use of the axial dispersion model for describing the gas holdup wave.

68 However, this comprehensive analysis did not take into account the contribution of the
 69 experimental uncertainty to the measured amplitude attenuation and phase shift. Thus, the
 70 objective of this paper is to fill this gap.

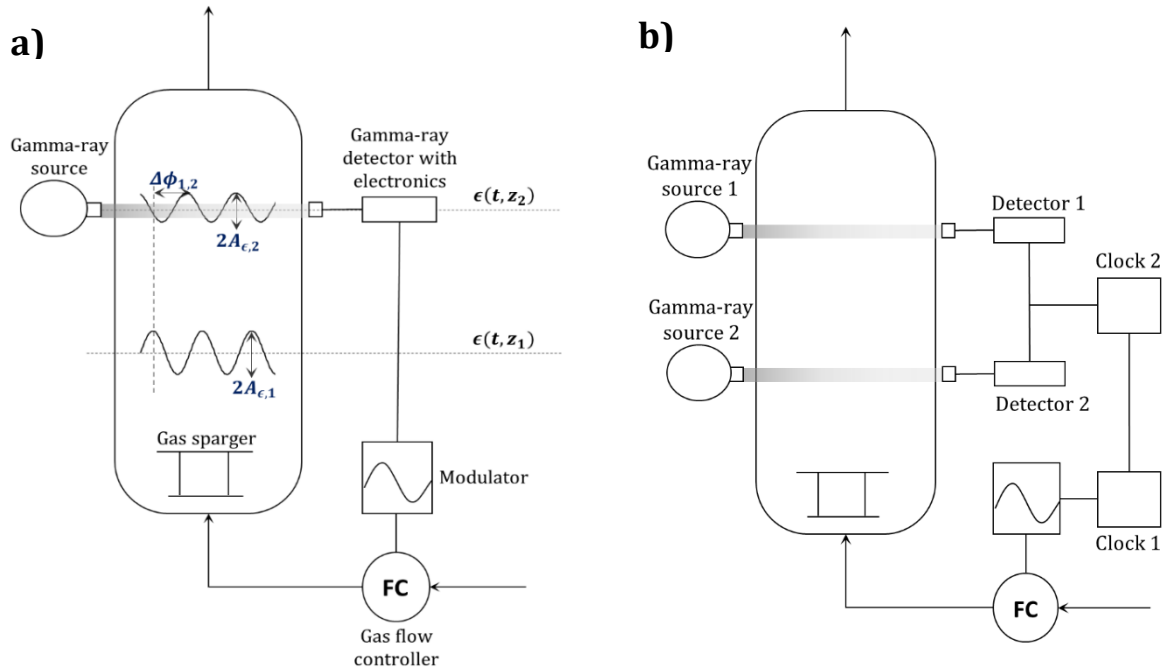

71

72 **Figure 1.** Simplified scheme of the experimental setup needed for axial gas dispersion
 73 coefficient measurement using gamma-ray densitometry with (a) one or (b) two
 74 synchronized detector elements and radiative sources.

75 An alternative arrangement to the one represented in **Figure 1a** is composed of two radiative
 76 sources and two detector elements. The detectors sample simultaneously at two different axial
 77 positions of the column and are synchronized with the same clock (Clock 2). The gas flow
 78 modulator, instead, relies on another clock (Clock 1). Both clocks are again synchronized with
 79 each other. This configuration allows measuring at the same time at both axial positions, reducing
 80 the impact of possible deviations in the process and the time needed to perform the
 81 measurements. A representative scheme is provided in **Figure 1b**.

82 In both configurations, the parameters contributing to experimental uncertainty are manifold and
 83 dependent on the specific setup. This work considers uncertainty sources that are common to
 84 most gamma-ray densitometry setups, i.e. statistics of the photon counting process, a mismatch

85 between the modelled and the real radiation propagation due to the spatial extent of the detector,
86 and a potential mismatch between modulation and sampling frequencies. In this study, numerical
87 experiments are preferred over real ones due to the high number of repetitions needed for each
88 experiment. Furthermore, such a numerical approach enables to decouple the above-mentioned
89 uncertainty sources that act together in real experiments.

90 The proposed approach is used to simulate the gamma-photons registered by a gamma-ray
91 detector to quantify the impact of the selected uncertainty sources depending on the operating
92 conditions as well as on column characteristics. The algorithm also supports optimizing the
93 scanning time and sampling frequency for cost-efficient experiments.

94

95 **2. Ensemble-averaging gamma-ray densitometry and uncertainty sources**

96 Gamma-ray densitometry is based on the measurement of the linear attenuation of radiation
97 within an object. Therefore, an isotopic source and a photon-counting detector are arranged
98 opposite to each other at the object of interest such that radiation from the source passes the
99 object and is registered by the detector. The detector counts single photons arriving from the
100 source. Hence, in the following we denote by N the number of photons being registered in a given
101 time interval ΔT . In case of a gas-liquid contactor, we find the following relationship for radiation
102 attenuation:

$$\langle N_{GL} \rangle = \langle N_G \rangle \exp(-\mu_L l(1 - \epsilon)). \quad 6$$

103 Here, $\langle N_{GL} \rangle$ is the expected number of photons registered per time interval for an operating
104 contactor (note, that subscript G stands for gas and L stands for liquid), $\langle N_G \rangle$ is the expected
105 number of photons one would register per time interval for the contactor containing no liquid.
106 Furthermore, μ_L is the linear attenuation coefficient of the liquid, l is the total length of the process
107 space the radiation beam passes and ϵ is the gas holdup within the beam path. Here, two technical
108 remarks are necessary. First, the derivation of Equation 6 assumes that the linear attenuation

109 coefficient of the gas phase $\mu_G = 0$. For contactors operating at very high pressures we may have
 110 $\mu_G > 0$, but this can be considered in a straightforward way. Second, in gamma-ray densitometry
 111 the detector will inevitably record some additional natural radiation in addition to the radiation
 112 from the isotopic source. It is therefore assumed that this constant offset is known and corrected.
 113 Every radiation-emission-detection process is associated with a statistical uncertainty. The count
 114 number in a time interval fluctuates and the statistical distribution of the count number is
 115 described by a Poisson distribution

$$P(N) = \frac{\langle N \rangle^N}{N!} \exp(-\langle N \rangle), \quad 7$$

116 where $P(N)$ is the probability of detecting N photons if $\langle N \rangle$ are expected. Note, that $N \in \mathbb{N}$ and
 117 $\langle N \rangle \in \mathbb{R}$.

118 To reduce the impact of the statistics of the photon counting process on measured amplitude and
 119 phase, Döß et al. [5] applied a lock-in detection scheme, that synchronises the detector data
 120 acquisition with the gas flow modulation. The detection events were then ensemble-averaged by
 121 counting them within $n_s = f_s/f$ equidistant scanning intervals, where f_s and f are the sampling
 122 and modulation frequencies, respectively. **Figure 2** illustrates this schematically. From here on,
 123 ensemble-averaged data are indicated with a tilde.

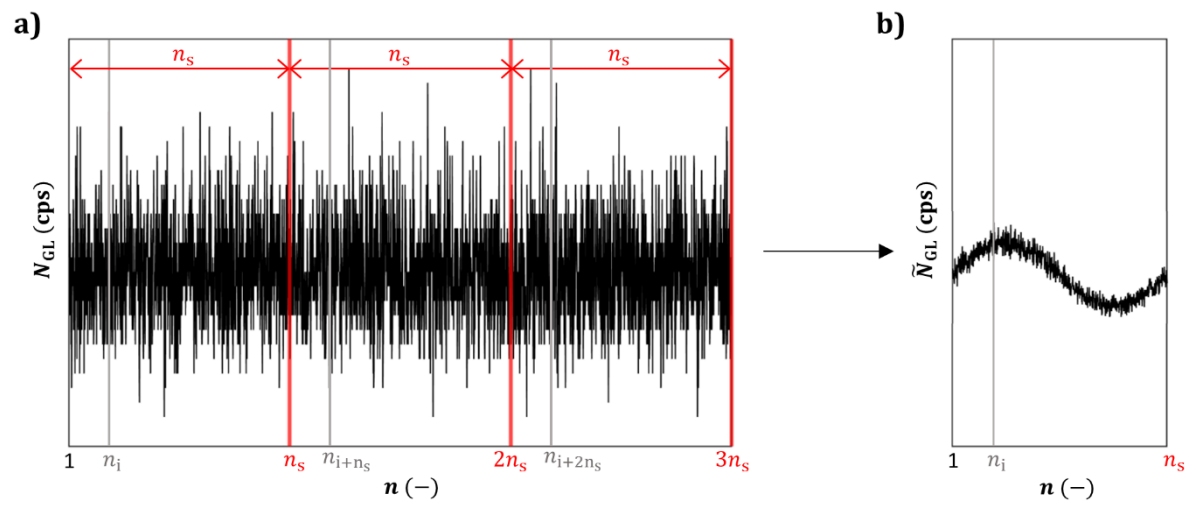

124

125 **Figure 2.** Schematic of the ensemble-averaging procedure, in which (a) the original detector
126 data stream is subdivided into single modulation periods that are (b) subsequently averaged to
127 reduce statistical noise. This way, the modified modulation wave is obtained.

128 As a result, one obtains the ensemble-averaged count number distributions for one modulation
129 period containing n_s values. This distribution is logarithmized to obtain gas holdup data. A cosine
130 function is then fitted to the resulting data, whose amplitude and phase are determined by a least-
131 squares criterion. Note that if there was no logarithmization one could also do a Fourier analysis
132 to obtain amplitude and phase.

133 Using gamma-ray densitometry one needs to consider its specific sources of uncertainty. First, the
134 gamma-ray detector is commonly assumed to be point-like. However, in reality, the extent of the
135 detector is a source of uncertainty. In case of a circular object (i.e. a column), the penetration
136 length changes along the detector width while the gas holdup wave changes its amplitude and
137 phase along the detector height. Another uncertainty source addressed in this study is a mismatch
138 between the modulation and sampling frequencies and vice versa. This may be due to
139 insufficiently synchronized clocks. Any mismatch between the modulation and sampling
140 frequencies reduces the reliability of the reconstructed amplitude and phase.

141

142 **3. Methodology**

143 In this section, we present an approach that predicts the gamma-photon rate registered by the
144 detector at a certain axial position. At a fixed axial position, the gas holdup for the sinusoidal
145 modulation is a function of time, that is

$$\epsilon(t) = \bar{\epsilon} + A_\epsilon \cos(\omega t + \phi), \quad 8$$

146 where $\bar{\epsilon}$ is the time-averaged gas holdup, A_ϵ is the modulation amplitude, and ϕ is the modulation
147 phase. Substituting Equation 8 in Equation 6, the expected number of counts in time for given
148 amplitude and phase of the gas holdup wave is

$$\langle N_{\text{GL}}(t) \rangle = \langle N_{\text{G}} \rangle \exp(-\mu_{\text{L}}(1 - \bar{\epsilon} - A_{\epsilon} \cos(\omega t + \phi))l). \quad 9$$

149 Equation 9 is used to model gamma-ray densitometry for assumed modulation parameters ($\bar{\epsilon}$, A_{ϵ} ,
 150 ϕ , ω), initial count number (N_{G}), column geometry (l) and working fluids (μ_{L}). Count numbers are
 151 simulated for n_{tot} equal-size time intervals between $t = 0$ and $t = t_{\text{tot}}$. For each time interval we
 152 compute a count number realization N_{GL} by drawing a Poisson-distributed number (Equation 7)
 153 using the expectation value computed from Equation 9. Having done so for all n_{tot} sampling points
 154 we perform the ensemble averaging and logarithmization which gives the gas holdup distribution
 155 for one ensemble-averaged period as

$$\bar{\epsilon}_{\text{i}}^* = \frac{1}{\mu_{\text{L}}l} \log \left(\frac{\tilde{N}_{\text{GL},i}}{\langle N_{\text{G}} \rangle} \right) + 1. \quad 10$$

156 Eventually, these data are then fitted by a cosine function as

$$\epsilon^*(t) = \bar{\epsilon}^* + A_{\epsilon}^* \cos(\omega t + \phi^*), \quad 11$$

157 obtaining the amplitude A_{ϵ}^* and phase ϕ^* . The comparison between A_{ϵ}^* and A_{ϵ} and between ϕ^* and
 158 ϕ provides a quantification of the uncertainty caused by the statistics of the photon counting
 159 process on amplitude damping and phase shift, respectively.

160 Since the fitting of the cosine function is only based on the specific values of \tilde{N}_{GL} , several
 161 repetitions of the same experiment are necessary to obtain a reliable assessment, as typical for
 162 Monte Carlo approaches. The results obtained this way offer more than 95% confidence level. It
 163 should be noted that the deviation caused by statistics of the photon counting process is physically
 164 inherent to all configurations and setups.

165 The detector size plays a role for the statistics of the photon counting process and further the
 166 spatial extent of the detector may have the consequence that radiation attenuation does no longer
 167 fit to a simple one-beam model. The count rate increases with the extension of the detector.
 168 Considering an empty process space, the number of detection events in a time interval ΔT is given
 169 by

$$\langle N_G \rangle = \frac{\Phi S \Delta T}{4\pi L^2}, \quad 12$$

170 where Φ is the gamma-radiation flux of the source (photon emission rate into the full solid angle
 171 of 4π sr) and S is the detector area. The geometrical parameters are illustrated in **Figure 3**. A
 172 bigger detector improves the statistics (since it increases $\langle N_G \rangle$). However, an increased detector
 173 size results in changes in the real object length accompanied by changes in the gamma-ray
 174 attenuation along the horizontal direction (detector width $L_{d,y}$). Additionally, the detector height
 175 $L_{d,z}$ affects the measurement since the amplitude and phase of the gas holdup wave change along
 176 the vertical axis of the contactor.

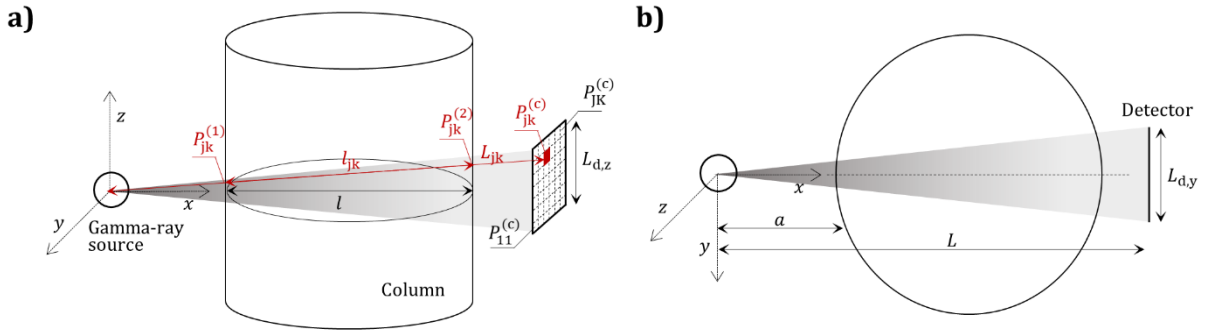

177
 178 **Figure 3.** Symbols used in Section 5 (parameters used describing a single detector element is
 179 labelled in red) and illustration of the effect of the detector height (a) and width (b).

180

181 4. Statistical uncertainty in the photon counting process

182 In this section, we assess the uncertainty in amplitude and phase caused by the statistics of the
 183 photon counting process. For this purpose, the detector is assumed small enough so that the
 184 penetration length is constant and equal to the length of the beam in the process space. Here,
 185 amplitude and phase do not change within the axial limits of the detector. The effect of the detector
 186 size will be analysed in Section 5. Considering a measurement time t_{tot} and a sampling frequency
 187 f_s , the total expected number of counts for each interval t_i of the modulation period (i.e., here $0 \leq$
 188 $t_i \leq 1/f$) is (see Equations 9 and 12)

$$\langle N_{GL,i} \rangle = \frac{t_{\text{tot}} f}{f_s} \langle N_G \rangle \exp(-\mu_L l (1 - \epsilon_i)). \quad 13$$

189 Defining

$$K_1 = \frac{t_{\text{tot}} f}{f_s} \langle N_G \rangle \exp\left(K_2 \left(1 - \frac{1}{\bar{\epsilon}}\right)\right), \quad 14$$

$$K_2 = \mu_L \bar{\epsilon} l, \quad 15$$

190 Equation 13 can be rewritten as

$$\langle N_{GL,i} \rangle = K_1 \exp(K_2 A \cos(\omega t_i + \phi)), \quad 16$$

191 where K_1 and K_2 are independent of the considered time interval. The above-presented algorithm
 192 is used to evaluate the effect of K_1 and K_2 on the standard deviations in amplitude damping and
 193 phase-shift, which are reported in **Figure 4** and defined as

$$\text{Dev}A = \frac{1}{A} \sqrt{\frac{1}{e} \sum_{i=1}^e (A_i^* - A)^2}, \quad 17$$

$$\text{Dev}\phi = \frac{1}{\phi} \sqrt{\frac{1}{e} \sum_{i=1}^e (\phi_i^* - \phi)^2}, \quad 18$$

194 where A and ϕ are the expected values of amplitude and phase, while A_i^* and ϕ_i^* are amplitude
 195 and phase obtained from each numerical experiment. The number of repetition for each
 196 experiment is indicated as e .

197 **Table 1** gives values of K_1 and K_2 for typical configurations and working fluids. An analysis of the
 198 effect of A and ϕ , for constant values of K_1 and K_2 is reported in the **Supplementary Material S1**.
 199 This analysis showed that the phase of the gas holdup has only a limited effect on the uncertainty
 200 on the phase itself. On the contrary, a higher amplitude substantially reduces the uncertainty of
 201 both in terms of amplitude and phase. However, as discussed by Marchini et al. [4], the initial

202 modulation amplitude should be kept below 15% to avoid an effect of the modulation on the
 203 hydrodynamics of the column.

204 **Table 1.** Examples of obtained K_1 and K_2 for different configurations.

Case N.	$\mu_L l$	$\langle N_G \rangle$	$t_{\text{tot}} f f_s^{-1}$	$\bar{\epsilon}$	K_1	K_2
(-)	(-)	(cps)	(s)	(-)	(s ⁻¹)	(-)
1	5	$4.9 \cdot 10^3$	14.4	0.1	783	0.5
2		$9.8 \cdot 10^3$			1566	
3		$2.7 \cdot 10^4$			4349	
4		$6.1 \cdot 10^4$			9785	
5		$1.3 \cdot 10^5$			19569	
6		$1.5 \cdot 10^5$			24462	
7	1	$1.3 \cdot 10^3$	1.7	0.15	941	0.15
8		$2.5 \cdot 10^3$			1882	
9			3.5		3764	
10			7.0		7529	
11			$4.9 \cdot 10^3$		15058	
12		14.4			30117	
13	1	$1.3 \cdot 10^3$	1.7	0.1	895	0.10
14		$2.5 \cdot 10^3$			1790	
15			3.5		3581	
16			7.0		7162	
17			$4.9 \cdot 10^3$		14324	
18		14.4			28648	

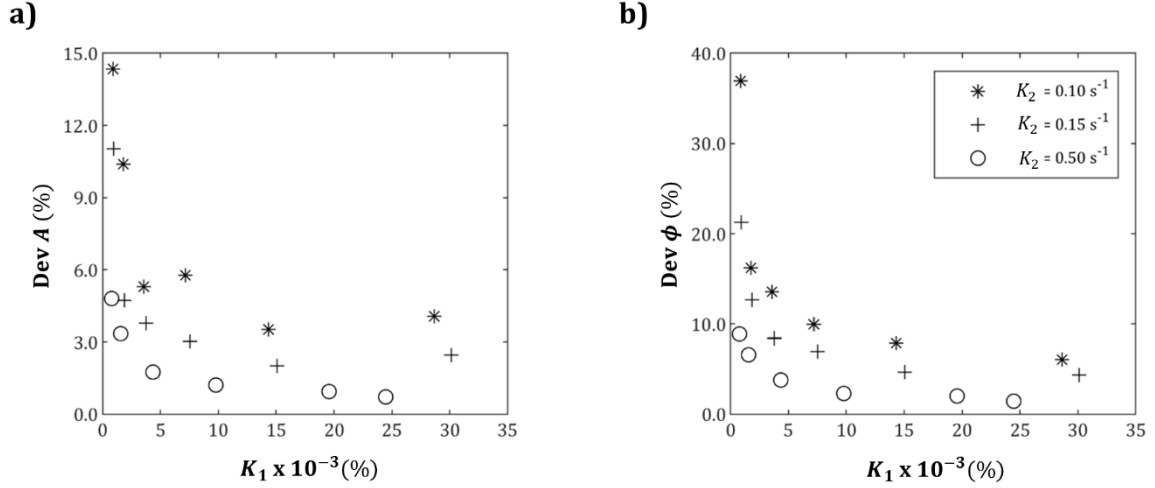

205

206

Figure 4. Deviation of amplitude and phase as a function of K_1 and for different values of K_2

207

($A = 0.15, \phi = 0.5$).

208

Figure 4 shows a decrease in both deviations increasing K_1 and K_2 . However, it should be noted

209

that K_1 itself is dependent on K_2 and it decreases significantly when the latter is increased.

210

211 5. Effect of the spatial extent of the detector

212

As pointed out in Section 4, the detector size influences the value of K_1 . In particular, a larger

213

detector can be used to increase the photon count rate and, therefore, reduce the deviation in

214

amplitude and phase. However, the changes along the detector surface in the length of the

215

radiation beam inside of the process space and in the gas holdup were not considered. In this

216

section, the impact of these assumptions is quantified in terms of additional uncertainty,

217

neglecting the effect of the statistics of the photon counting process.

218

The problem is approached dividing the detector into a number of small rectangular sections with

219

columns (index j) and rows (index k) and center coordinates $P_{jk}^{(c)}(x_{jk}^{(c)}, y_{jk}^{(c)}, z_{jk}^{(c)})$ as shown in

220

Figure 3a. Accordingly, each detector section contributes with

$$N_{GL,jk} = N_{G,jk} \exp(-(1 - \bar{\epsilon})\mu_L L_{jk}) \exp\left(A_{\epsilon,0}\mu_L \int_0^{l_{jk}} V(l') \cos(\omega t + \Delta\phi(l')) dl'\right). \quad 19$$

221 If the ray penetrates and leaves the column (considered as an empty cylindrical process space) in

222 $P_{jk}^{(1)}(x_{jk}^{(1)}, y_{jk}^{(1)}, z_{jk}^{(1)})$ and $P_{jk}^{(2)}(x_{jk}^{(2)}, y_{jk}^{(2)}, z_{jk}^{(2)})$, respectively, the penetration length is

$$l_{jk} = \sqrt{(x_{jk}^{(2)} - x_{jk}^{(1)})^2 + (y_{jk}^{(2)} - y_{jk}^{(1)})^2 + (z_{jk}^{(2)} - z_{jk}^{(1)})^2}. \quad 20$$

223 The total number of counts reaching the detector is given by the sum of the counts reaching each

224 section, that is

$$N_{GL} = F \sum_{k=1}^K \sum_{j=1}^J \frac{1}{L_{jk}^2} \exp(-(1 - \bar{\epsilon})\mu_L l_{jk}) \cdot \exp\left(A_{\epsilon,0}\mu_L C \int_{z_{jk}^{(1)}}^{z_{jk}^{(2)}} \exp(H_1 z) \cos(\omega t + H_2 z + \phi_0) dz\right), \quad 21$$

225 where

$$F = \frac{\Phi S}{4\pi f_s} \quad 22$$

$$H_1 = \frac{u_G^*}{2D_G} \left[1 - \frac{1}{\sqrt{2}} \sqrt{1 + \sqrt{1 + \frac{16\omega^2 D_G^2}{u_G^{*4}}}} \right], \quad 23$$

$$H_2 = -\frac{u_G^*}{D_G \sqrt{8}} \left[\sqrt{\sqrt{1 + \frac{16\omega^2 D_G^2}{u_G^{*4}}} - 1} \right], \quad 24$$

$$C = \sqrt{1 + \left(\frac{x_{jk}^{(2)} - x_{jk}^{(1)}}{z_{jk}^{(2)} - z_{jk}^{(1)}}\right)^2 + \left(\frac{y_{jk}^{(2)} - y_{jk}^{(1)}}{z_{jk}^{(2)} - z_{jk}^{(1)}}\right)^2} \quad 25$$

226 and

$$L_{jk} = \sqrt{x_{jk}^{(c)2} + y_{jk}^{(c)2} + z_{jk}^{(c)2}}. \quad 26$$

227 The detailed derivation of Equation 21 is given in the **Supplementary Material S2**.

228 Equation 21 was solved numerically for given values of $F/S, H_1, H_2, A_{\epsilon,0}\mu_L$ and for a given relative
 229 position between the column and the measurement system. The solution was obtained for
 230 different normalized values of the detector width and height ($L_{d,y}/l$ and $L_{d,z}/l$ in **Figure 5**) and
 231 for each time step t_i considering a single modulation period. The obtained number of counts was
 232 then converted into holdup data as

$$\epsilon_i^* = 1 + \frac{1}{\mu_L l} \ln \left(\frac{L^2 N_{GL,i}}{F} \right) = \bar{\epsilon}^* (1 + A^* \cos(\omega t_i + \phi^*)) \quad 27$$

233 and fitted by a cosine function. The obtained amplitude, phase and average holdup are then
 234 compared with their expected values $\bar{\epsilon}, \phi = H_2 z + \phi_0$ and $A = A_{\epsilon,0} \exp(H_1 z)$. **Figure 5** reports
 235 the obtained results for

$$\text{Dev}A = \frac{A^* - A}{A}, \quad 28$$

$$\text{Dev}\phi = \frac{\phi^* - \phi}{\phi}, \quad 29$$

$$\text{Dev}\bar{\epsilon} = \frac{\bar{\epsilon}^* - \bar{\epsilon}}{\bar{\epsilon}}. \quad 30$$

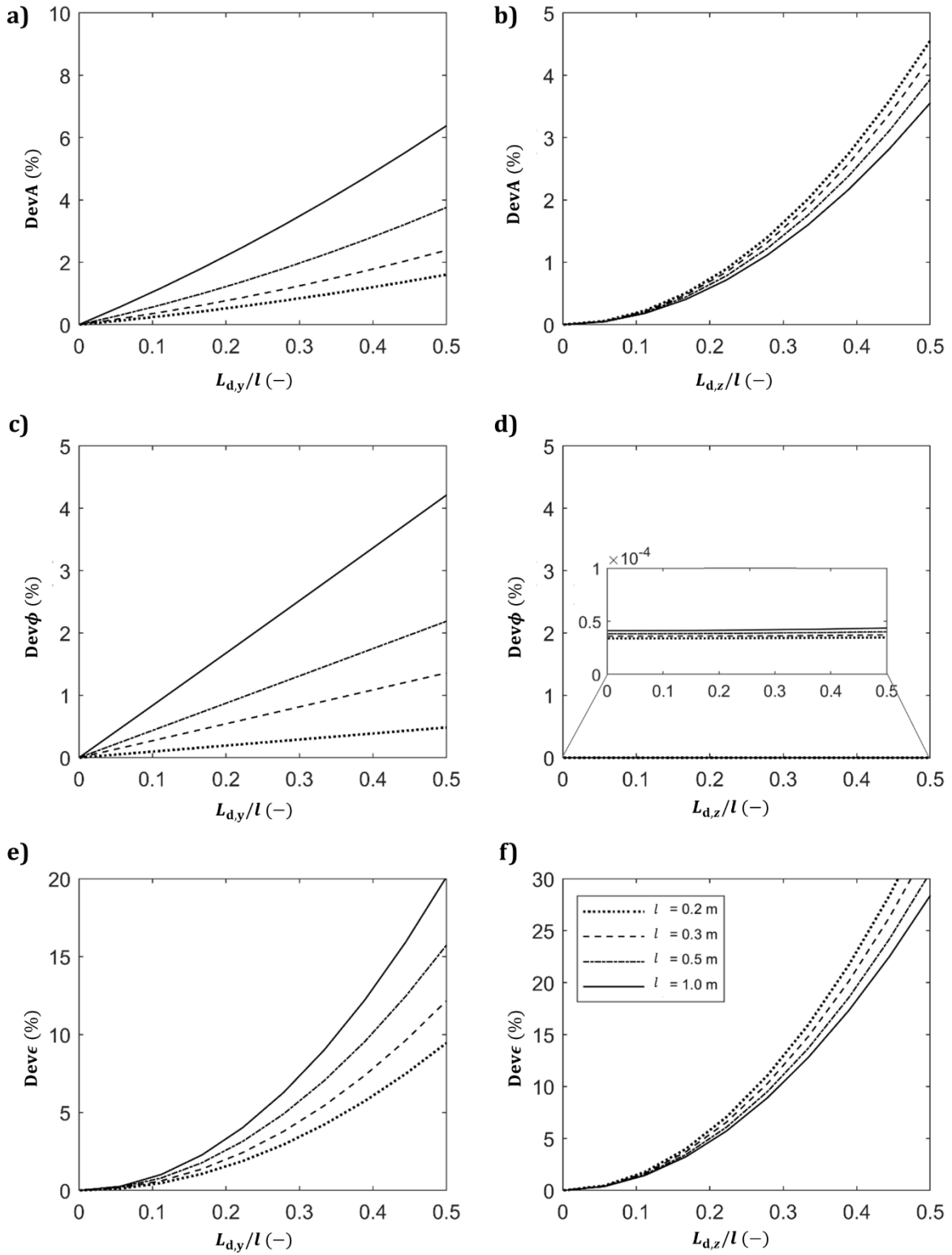

236

237 **Figure 5.** Deviations on (a-b) amplitude, (c-d) phase and (e-f) average values of the gas holdup
 238 wave, as a function of detector width and height normalized by the length of the radiation beam

239 in the process space ($H_1 = -0.3669 \text{ m}^{-1}$, $H_2 = 1.9502 \text{ m}^{-1}$, $F/S = 8 \cdot 10^5 \text{ m}^{-2}$, $A_{\epsilon,0}\mu_L =$

240 0.1 m^{-1} , $L = 0.4 \text{ m}$, $a = 0.3 \text{ m}$).

241 Other examples for different values of H_1 and H_2 are reported in the **Supplementary Material**
 242 **S3**. The results show that the detector size has only a marginal influence on amplitude, phase and
 243 average value of the measured gas holdup wave. Thus, larger detectors (or combining several
 244 smaller ones) are recommended to reduce the total measurement time. It should be kept in mind,
 245 however, that for large detectors the deviation on the average holdup value might be non-
 246 negligible (see **Figure 5e,f**). The average holdup is linked with the bubble swarm velocity via $u_G^* =$
 247 $u_G/\bar{\epsilon}$, and a deviation on the bubble swarm velocity causes an additional deviation on the obtained
 248 axial gas dispersion coefficient, which is not considered here. This deviation has been analysed by
 249 Marchini et al. [4].

250

251 **6. Impact of a frequency mismatch on measured amplitude and phase**

252 When quartz-controlled timers are used in the measurement system, no relevant shift is expected
 253 between the sampling and modulation frequencies. However, to highlight the importance of
 254 correct synchronization the impact of a frequency shift is addressed here.

255 **6.1 Quantification of the impact of a frequency mismatch on measured amplitude** 256 **and phase**

257 The deviation caused by a mismatch between the sampling and modulation frequencies is
 258 quantified modifying the algorithm proposed in Section 3. In this case, the real modulation and
 259 sampling frequencies f^* and f_s^* , respectively, are used to simulate the count data set sampled by
 260 the detector. In order to quantify the deviation, this obtained data set is then wrongly ensemble-
 261 averaged based on the expected number of intervals per modulation period n_s . Defining

$$\text{Dev}n_s = \frac{n_s^* - n_s}{n_s}, \quad 31$$

262 where $n_s^* = f_s^*/f^*$, **Figure 6** reports an example of the impact of this frequency mismatch on the
 263 determined amplitude and phase in terms of $\text{Dev}A$ and $\text{Dev}\phi$, as defined in Equations 28 and 29,

264 respectively. For the sake of simplicity, signals free from other uncertainty sources are used here
 265 and f_s^*/f^* is assumed integer.

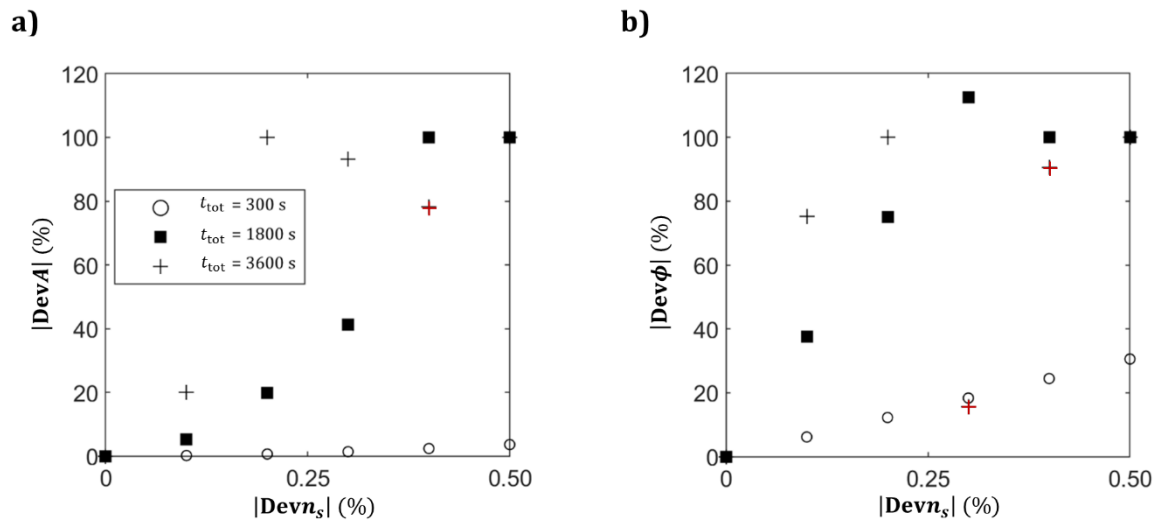

266

267 **Figure 6.** Impact of an unexpected deviation in the number of intervals per modulation period
 268 on amplitude and phase of the gas holdup wave (for $A = 0.15$, $\phi = 1.5$ rad, $K_1/(t_{\text{tot}}f) =$
 269 19.9 s^{-1} , $K_2 = 0.1$). $|\text{Dev}A|$ and $|\text{Dev}\phi|$ generally increase with $|\text{Dev}n_s|$. Points deviating from
 270 this trend are highlighted in red.

271 The impact of the frequency shift on the ensemble-averaged signal increases with the total
 272 scanning time and with the shift magnitude, reaching 100%. The few points deviating from the
 273 main trend in **Figure 6** (highlighted in red) are due to the periodicity of the cosine function or due
 274 to the inadequacy of the fitting function, as amplitudes approach zero. **Figure 6** shows that even
 275 a minor undetected change can cause the failure of the ensemble-averaging approach, especially
 276 for long total scanning times. An analytic prediction of the deviation caused in such a scenario is
 277 provided in the **Supplementary Material S4**.

278

279 6.2 Determining the modulation frequency from available detector data

280 If the modulation frequency is not known, it can be determined employing a discrete Fourier
 281 transform to the detector data. This, however, introduces an uncertainty in the determined

282 frequency, which is quantified in this subsection. The maximum uncertainty of the determined
 283 frequency corresponds to the resolution of the frequency vector of the discrete Fourier transform
 284 equal to

$$\Delta f = \frac{1}{t_{\text{tot}}}. \quad 32$$

285 Based on Equation 31, the resolution of the Fourier transform causes a maximum deviation of n_s
 286 for given sampling frequency and total scanning time given by

$$\text{Dev}n_s = \frac{1}{t_{\text{tot}}f_s} n_s^*. \quad 33$$

287 For small deviation values

$$\text{Dev}n_s \cong \frac{1}{t_{\text{tot}}f_s} n_s. \quad 34$$

288 Therefore, the deviation caused by the limited resolution of the fast Fourier transform decreases
 289 increasing $t_{\text{tot}}f_s$ and increases linearly with n_s .

290 **Figure 7** shows examples of how the uncertainty of the determined frequency (defined as in
 291 Equation 31) changes with the sampling time and the number of intervals per period n_s .

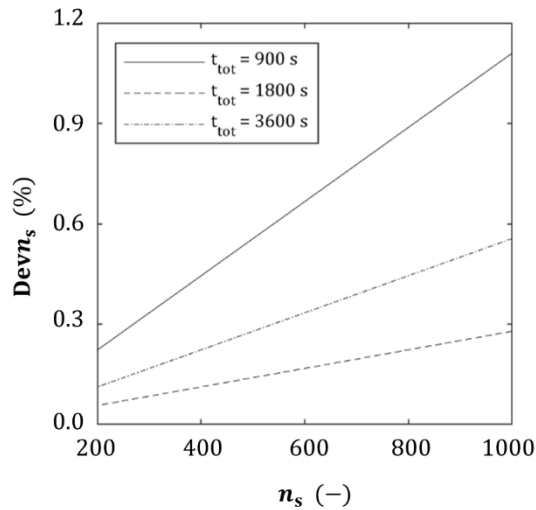

292
 293 **Figure 7.** Deviation of the measured number of intervals per modulation period as a function of
 294 the expected value.

295 The shortcomings of the discrete fast Fourier transform are well-known in the literature and
296 several techniques have been proposed to reduce the uncertainty of the determined frequency,
297 for example by Kanatov et al. [6] and by Gasior and Gonzalez [7]. More specifically, the Gaussian
298 interpolation of the frequency spectrum, proposed by Gasior and Gonzalez [7], is proved to reduce
299 this uncertainty by up to three orders of magnitude. The application of these techniques allows
300 reducing the uncertainty way more than increasing the total scanning time and should therefore
301 be preferred.

302 Even a very small uncertainty of 0.1% on the sampling over the modulation frequency ratio can
303 cause the failure of the approach (see **Figure 6**). Thus, care must be taken in selecting proper
304 clocks for measurement system and signal detection. In addition, techniques to reduce the
305 deviation due to the discrete nature of the fast Fourier transform should be implemented in the
306 analysis, if the modulation frequency is not exactly known.

307

308 **7. Uncertainties of the axial dispersion coefficient**

309 When performing measurements, the average gas holdup value as well as the amplitude and phase
310 of its wave at certain axial positions are obtained. This study quantifies the experimental
311 uncertainties associated with these parameters, when gamma-ray densitometry is used as
312 measurement technique. However, the experimental uncertainty for amplitude damping and
313 phase-shift obtained from this study must be combined with the inherent uncertainty (related to
314 the assumptions involved in Equations 4 and 5) that has been analyzed recently by Marchini et al.
315 [4]. This allows obtaining the resulting uncertainty of the measured axial dispersion coefficient.
316 For clarity, a scheme of contributions of inherent and experimental uncertainty is provided in
317 **Figure 8**.

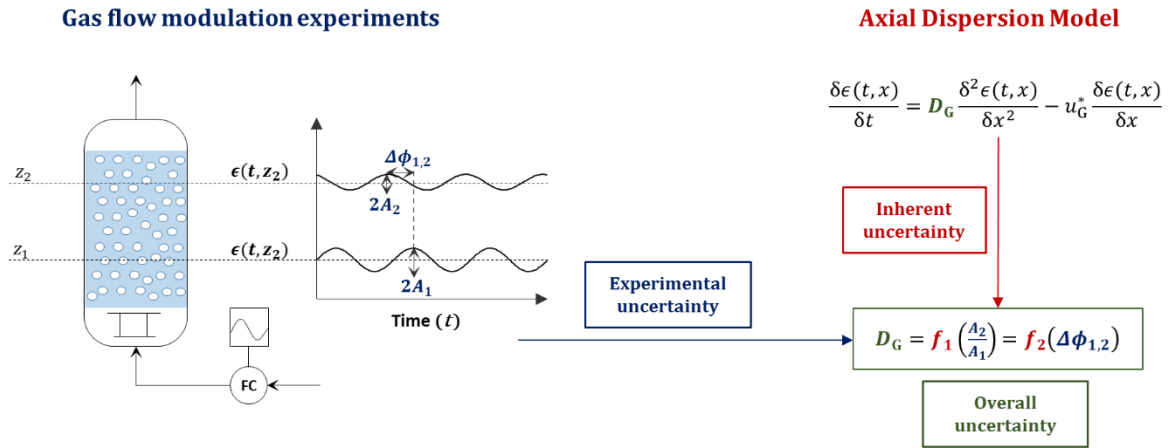

318

319 **Figure 8.** Scheme of experimental and inherent uncertainties influencing the overall uncertainty
 320 of the axial gas dispersion coefficient.

321 Marchini et al. [4] analyzed the derivative of the amplitude damping and phase-shift with respect
 322 to the axial dispersion coefficient. These are functions of the modulation and geometric
 323 parameters, the bubble rise velocity and the axial gas dispersion coefficient itself. Therefore, the
 324 same uncertainty of amplitude damping and phase-shift leads to different uncertainties on the
 325 axial gas dispersion coefficient considering different conditions.

326 As an example, **Figure 8** shows the sensitivity of the amplitude damping and phase-shift to the
 327 axial dispersion coefficient for different bubble rise velocities.

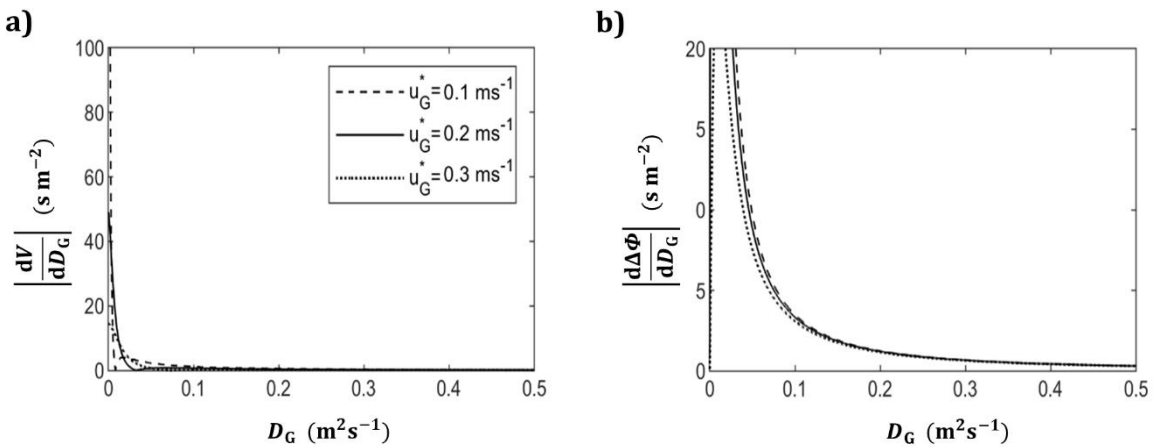

328

329 **Figure 8.** Sensitivity of (a) the amplitude damping and (b) the phase-shift to the axial gas
 330 dispersion coefficient obtained for different bubble rise velocities ($f = 0.4$ Hz, $\Delta x = 0.2$ m).

331 **8. Conclusions**

332 We presented a study on the uncertainty of gamma-ray densitometry applied to the gas flow
333 modulation technique and considered therefore the statistics of the photon counting process. The
334 analyses shows that the measuring uncertainty, in principle, can be reduced by increasing the
335 modulation amplitude, while modulation and sampling frequencies have no effects. However, this
336 practice should be discouraged, since the modulation amplitude should always be kept below 0.15
337 as shown by Marchini et al. [4].

338 A reliable and systematic approach was proposed for quantifying the experimental uncertainty
339 on the determined amplitude and phase of the gas holdup wave for various setup characteristics
340 and operating conditions. The uncertainty connected with the detector size was quantified, too.
341 In this way, in addition to increasing the total scanning time, the use of larger detectors (or the
342 averaging of more adjacent detector elements) is a proper mean for reducing the uncertainty
343 caused by the photon counting process. In this case, however, a well-centred alignment between
344 source, column and detector is crucial.

345 It was further shown that the sampling frequency can be directly determined from the obtained
346 data, applying a discrete fast Fourier transform. However, even an unexpected minimum
347 deviation in the number of intervals per modulation period (i.e. in the frequency) can cause a
348 failure of the ensemble-averaging approach. For this reason, extreme care should be taken in
349 selecting the applied clocks and the limited resolution of the discrete Fourier transform should be
350 kept in mind.

351 Altogether, the proposed algorithm and derived guidelines represent a powerful support for
352 designing gamma densitometry measurement systems for future applications of the GFM
353 (including characteristics of gamma-ray source and detector, geometry of the apparatus and
354 needed performances of the clocks), as well as for selecting appropriate total scanning time,
355 sampling frequency and modulation frequency.

356

357 **9. Acknowledgement**

358 This work was supported by the German Research Foundation (DFG) (HA 3088/18-1).

359

Nomenclature	Unit
a	Distance between source and column along the x axis for $y=0$ and $z=0$. m
A	Amplitude of the sinusoidal gas holdup wave
A_ϵ	Amplitude of the sinusoidal gas wave times average gas holdup.
$A_{\epsilon,0}$	Initial amplitude of the sinusoidal gas wave times average gas holdup.
$DevA$	Deviation of the measured amplitude of the gas holdup wave
c	Concentration of selected species in the studied phase mol m ⁻³
C	Parameter used in Section 5, defined as $C =$ $\sqrt{1 + \left(\frac{x_{jk}^{(2)} - x_{jk}^{(1)}}{z_{jk}^{(2)} - z_{jk}^{(1)}}\right)^2 + \left(\frac{y_{jk}^{(2)} - y_{jk}^{(1)}}{z_{jk}^{(2)} - z_{jk}^{(1)}}\right)^2}$ m
D	Axial gas dispersion coefficient m ² s ⁻¹
e	Number of repetitions of a single experiment
E	Time-domain Fourier transform of the gas holdup distribution
f	Modulation frequency Hz
Δf	Resolution of the frequency vector of the Fourier transform Hz
f_s	Sampling frequency Hz
F	Parameter used in Section 5, $F = \frac{\Phi S}{4\pi f_s}$
H_1	Parameter used in Section 5 defined as m ⁻¹

$$H_1 = \frac{u_G^*}{2D_G} \left[1 - \frac{1}{\sqrt{2}} \sqrt{1 + \sqrt{1 + \frac{16\omega^2 D_G^2}{u_G^{*4}}}} \right]$$

H_2 Parameter used in Section 5 defined as m^{-1}

$$H_2 = -\frac{u_G^*}{D_G \sqrt{8}} \left[\sqrt{\left[\sqrt{1 + \frac{16\omega^2 D_G^2}{u_G^{*4}}} \right]} - 1 \right]$$

K_1 Parameter used in Section 4 defined as $K_1 =$ cps

$$\frac{t_{\text{tot}} f}{f_s} \langle N_G \rangle \exp\left(K_2 \left(1 - \frac{1}{\bar{\epsilon}}\right)\right)$$

K_2 Parameter used in Section 4 defined as $K_2 = \mu_L \bar{\epsilon} l$

l length of the radiation beam in the process space m

L Distance between source and detector m

$L_{d,z}$ Detector width m

$L_{d,y}$ Detector height m

n Scanning interval

n_s Number of scanning intervals per modulation period

$Dev n_s$ Overall deviation of the determined number of intervals per modulation period

n_{tot} Total number of intervals in the total measurement time

N Number of counted photons cps

$\langle N \rangle$ Expected number of counted photons cps

$\langle N_G \rangle$ Expected number of counts for the gas-filled column cps

$\langle N_{GL} \rangle$ Expected number of counts for the gas-liquid-filled column cps

\tilde{N}_{GL} Ensemble-averaged number of counts for the gas-liquid-filled column

P Probability

$P^{(c)}$	Center of the detector element with coordinates $x^{(c)}, y^{(c)}, z^{(c)}$	
$P^{(1)}$	Point where the considered gamma-ray penetrates the column with coordinates $x^{(1)}, y^{(1)}, z^{(1)}$	
$P^{(2)}$	Point where the considered gamma-ray exits the column with coordinates $x^{(2)}, y^{(2)}, z^{(2)}$	
S	Detector surface ($S = L_{d,z}L_{d,y}$)	m^2
t	Time	s
t_{tot}	Total measurement time	s
u	Superficial velocity	ms^{-1}
u_G^*	Bubble rise velocity	ms^{-1}
V	Amplitude damping between two axial positions	
x, y	Coordinate axis with origin corresponding to the gamma-source	m
z	Axial coordinate of the bubble column (distance from the sparger)	m
Δz	Axial distance between the two measurement points	m
Greek letters		
μ	Attenuation coefficient	m^{-1}
ϵ	Expected gas holdup wave	
$\tilde{\epsilon}$	Expected ensemble-averaged gas holdup wave	
$\bar{\epsilon}$	Expected gas holdup wave averaged over the entire measurement time	
$Dev\bar{\epsilon}$	Deviation of the measured average gas holdup	
ϕ	Phase of the gas holdup wave	rad
$\Delta\phi$	Phase-shift in the gas holdup wave between the measurement points	rad
$Dev\phi$	Deviation on the phase of the gas holdup wave	

Φ	Photon intensity	cps sr ¹
ω	Angular modulation frequency	rad s ⁻¹

Subscripts

i, j, w, k	Indexes
G	Gas phase
L	Liquid phase

Superscripts

j, i	Refers to detector element (j,i)
*	Measured value (in contrast to the expected value)

360 References

- 361 [1] U. Hampel, Anordnung und Verfahren zur Dispersionsmessung sowie Mehrphasenapparat mit
362 einer solchen Anordnung. Patent DE 10 2014 118 649 B3 2015.12.24., 2015.
- 363 [2] M.V. Kantak, S.A. Shetty, B.G. Kelkar, Liquid-Phase Backmixing in Bubble-Column Reactors - a New
364 Correlation, Chemical Engineering Communications 127 (1994) 23-34.
- 365 [3] F. Demaria, R.R. White, Transient Response Study of Gas Flowing through Irrigated Packing, Aiche
366 Journal 6 (1960) 473-481.
- 367 [4] S. Marchini, M. Schubert, U. Hampel, Analysis of the effect of uncertainties in hydrodynamic
368 parameters on the accuracy of the gas flow modulation technique for bubble columns, Chemical
369 Engineering Journal 434 (2022).
- 370 [5] A. Döß, M. Schubert, A. Bieberle, U. Hampel, Non-invasive determination of gas phase dispersion
371 coefficients in bubble columns using periodic gas flow modulation, Chemical Engineering Science
372 171 (2017) 256-270.

- 373 [6] I. Kanatov, D. Kaplun, D. Butusov, V. Gulvanskii, A. Sinitca, One Technique to Enhance the
374 Resolution of Discrete Fourier Transform, Electronics 8 (2019) 330.
- 375 [7] M. Gasior, J. Gonzalez, Improving FFT frequency measurement resolution by parabolic and
376 gaussian interpolation, CERN-AB-Note-2004-021, 2004.
- 377